

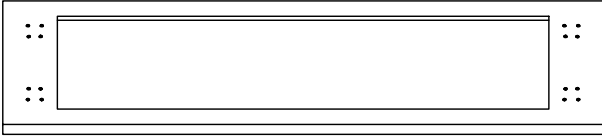
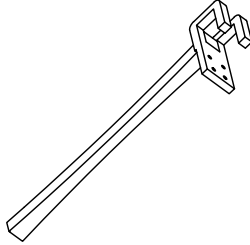

ITEM NAME/NOM D'ITEM: RENCH CONSOLE TABLE

ITEM #/NO. ITEM: 110593

PARTS LIST/LISTE DES PIÈCES

<p>(1)</p>  <p>x1</p>	<p>(2)</p>  <p>x4</p>			
<p>(3)</p> <p>A.</p>  <p>11/16" x 7/32"</p> <p>x16</p>	<p>B.</p>  <p>7/32"</p> <p>x16</p>	<p>C.</p>  <p>7/32"</p> <p>x16</p>	<p>D.</p>  <p>4mm</p> <p>x1</p>	<p>E.</p>  <p>Furniture Tipping Restraint</p> <p>x1</p>

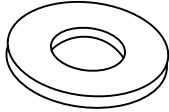
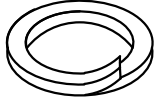
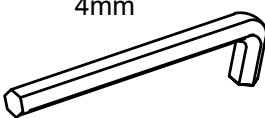
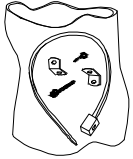
ASSEMBLY INSTRUCTIONS/INSTRUCTIONS D'ASSEMBLAGE

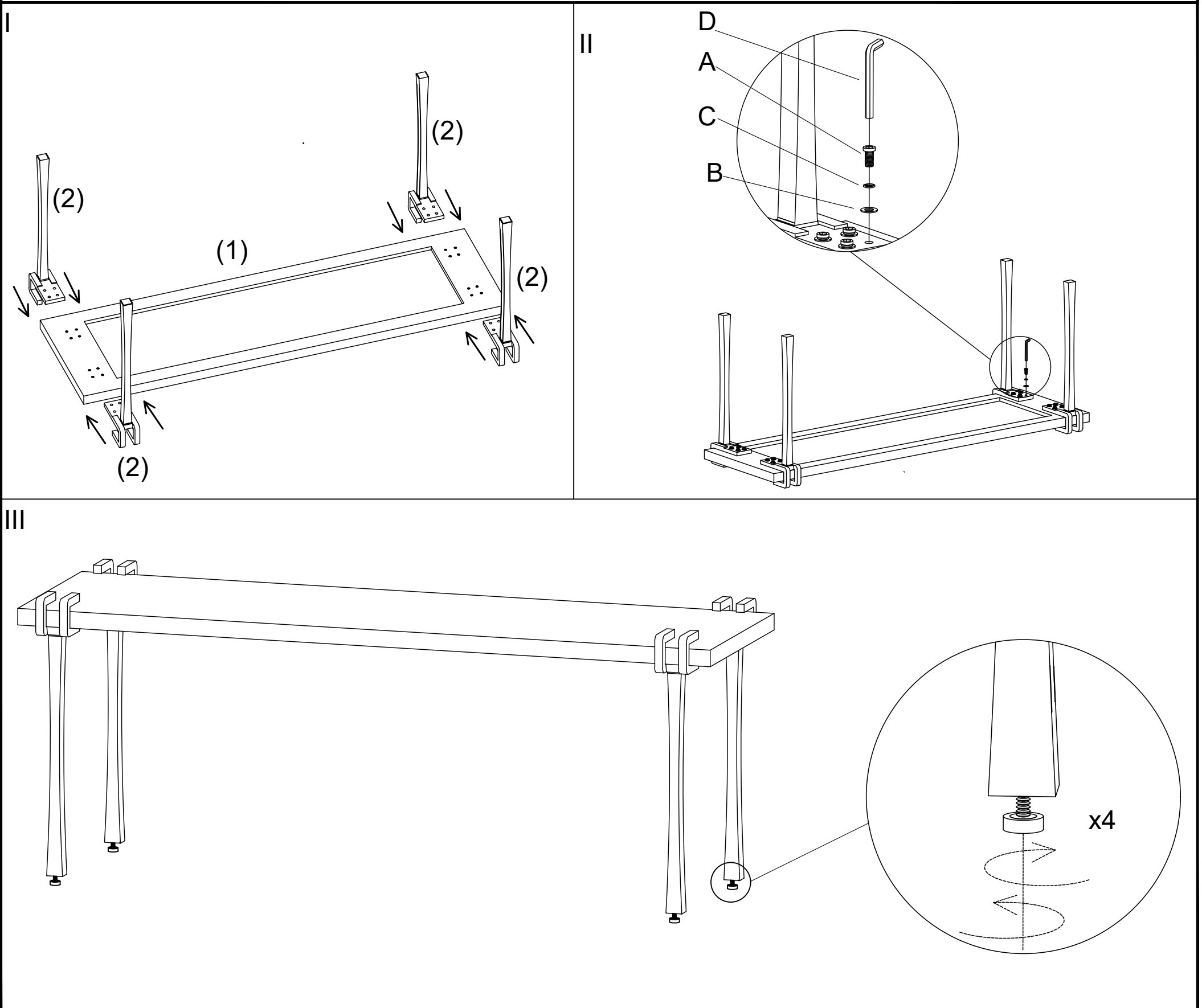

ITEM NAME/NOM D'ITEM: RENCH CONSOLE TABLE

ITEM #/NO. ITEM: 110593

To install the furniture tipping restraint:

1. Determine the approximate location where the console table will be placed. Locate a wall stud.
2. Attach one of the 'L' brackets to the wall stud using 2" screw through the small hole in the 'L' bracket.
3. Position the console table then install the strap around the leg of console table and through the 'L' bracket as shown.

