

ITEM NAME /NOM D'ITEM:DESI CHAIR

ITEM # /NO. ITEM:109068 (WHITE/BLANC)

Enquiry:parts@zuomod.com

PART LIST/Liste des pièces

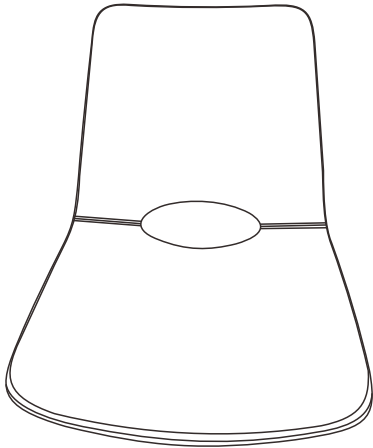

(1)

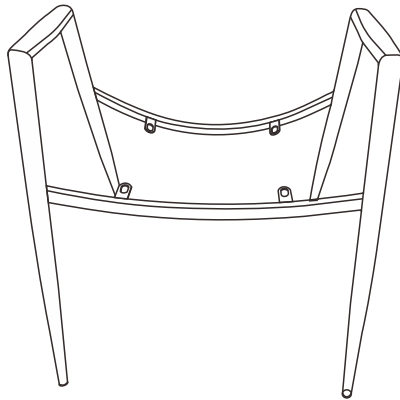

(2)



(3)

- | | | | |
|----|---|----|---------|
| 1. |  | X4 | M5*20mm |
| 2. |  | X4 | |
| 3. |  | X1 | |

INSTRUCTION

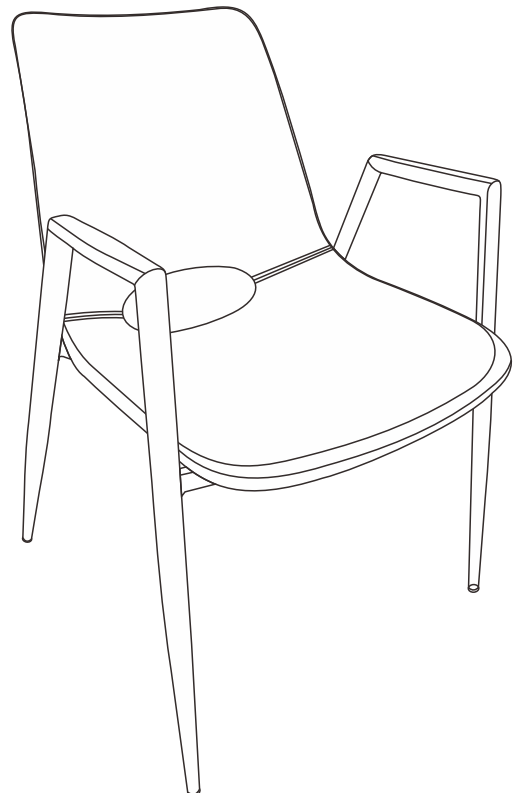
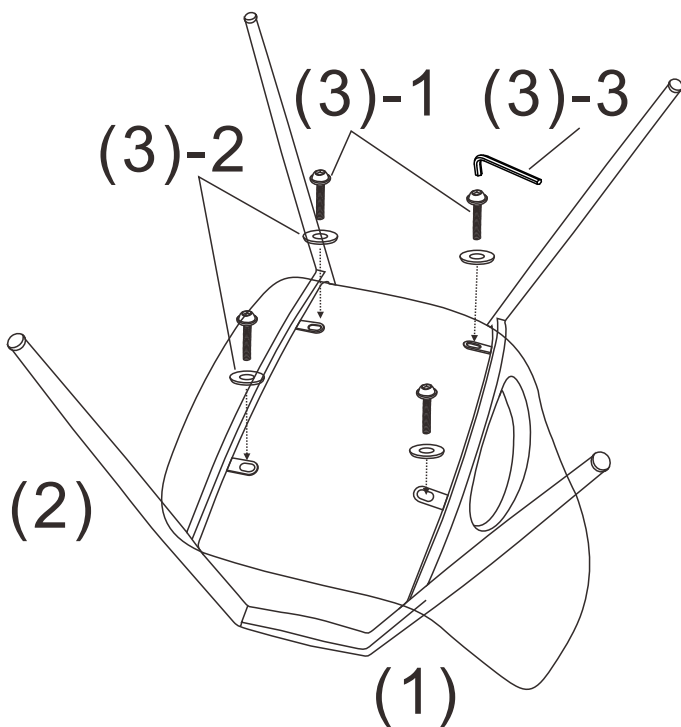

ITEM NAME / NOM D'ITEM : DESI DINING CHAIR

ITEM # / NO. ITEM : 109550 (WHITE & GOLD SS)

Enquiry : parts@zuomod.com

PARTS LIST / Liste des pièces

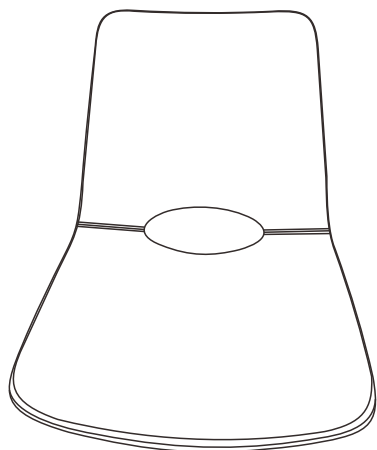

(1)

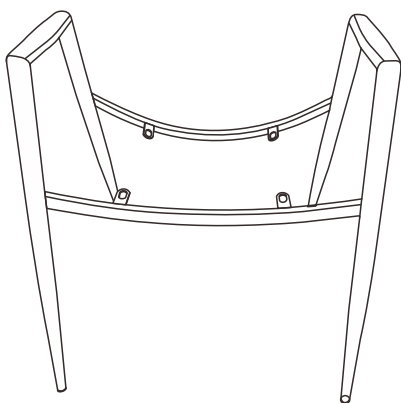

(2)



(3)

- | | | | |
|----|---|----|---------|
| 1. |  | X4 | M6*20mm |
| 2. |  | X4 | |
| 3. |  | X1 | |

INSTRUCTIONS

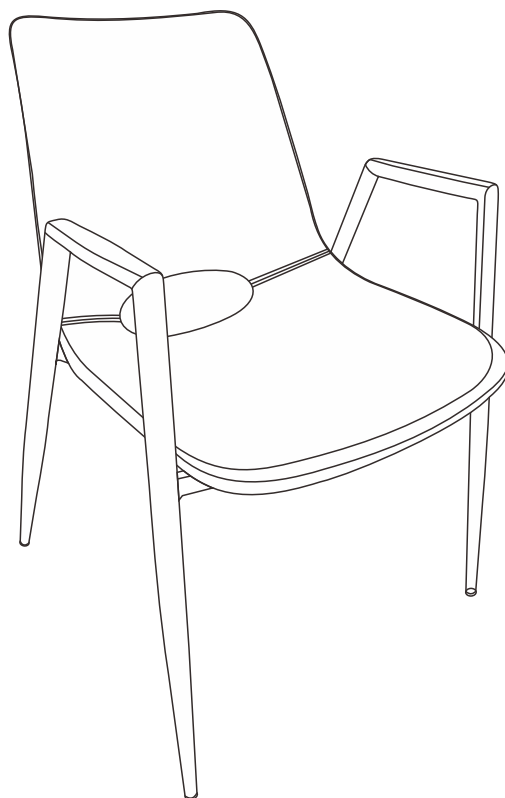
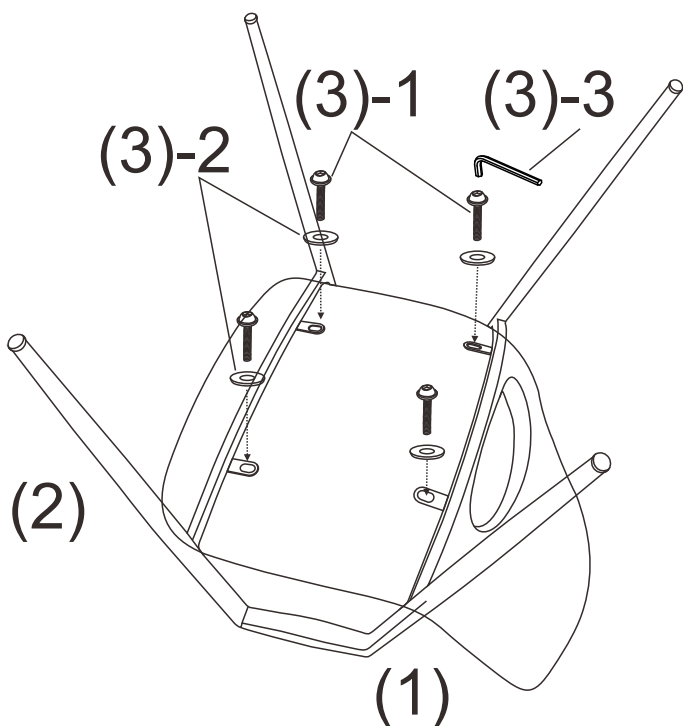

ITEM NAME / NOM D'ITEM : DESI DINING CHAIR

ITEM # / NO. ITEM : 109535 (WHITE & BLACK)

Enquiry : parts@zuomod.com

PARTS LIST / Liste des pièces

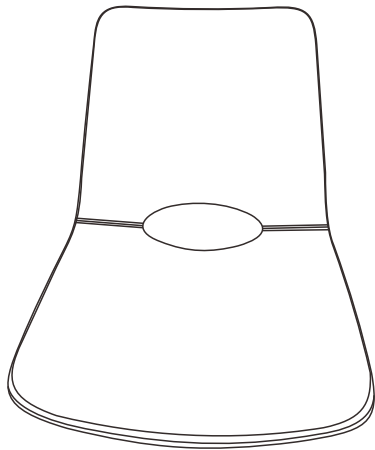

(1)

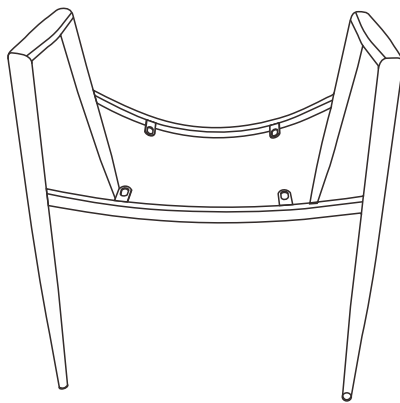

(2)



(3)

- | | | | |
|----|---|----|---------|
| 1. |  | X4 | M6*20mm |
| 2. |  | X4 | |
| 3. |  | X1 | |

INSTRUCTIONS

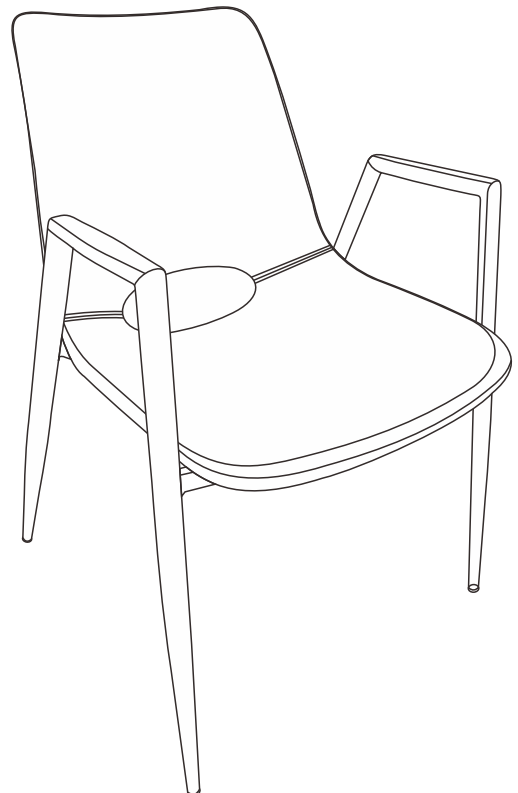
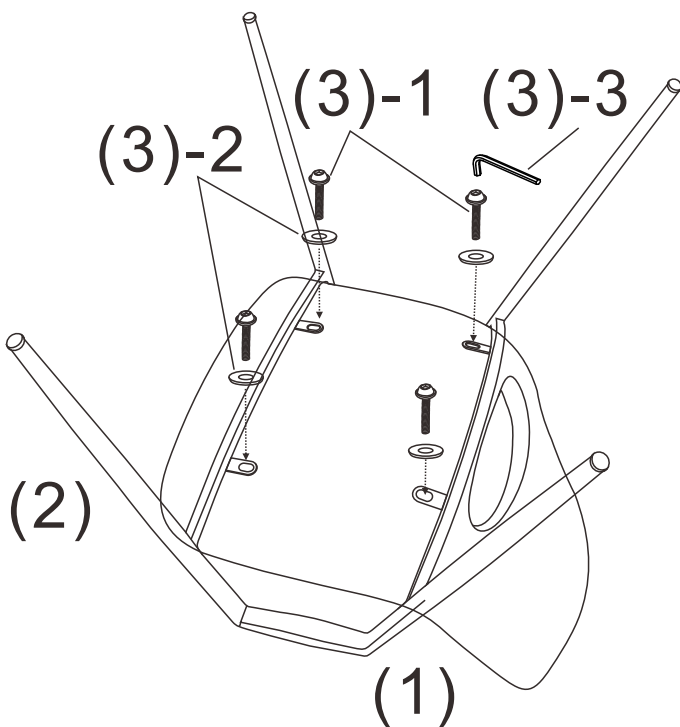

ITEM NAME / NOM D'ITEM : DESI DINING CHAIR

ITEM # / NO. ITEM : 109730 (BROWN & WALNUT)

Enquiry : parts@zuomod.com

PARTS LIST / Liste des pièces

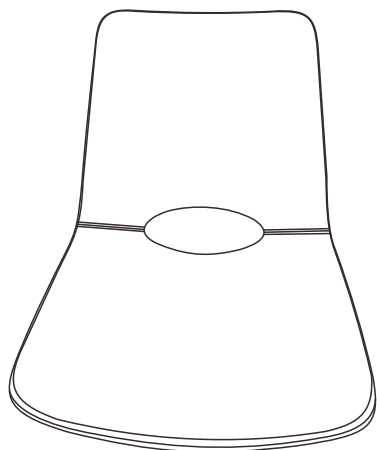

(1)

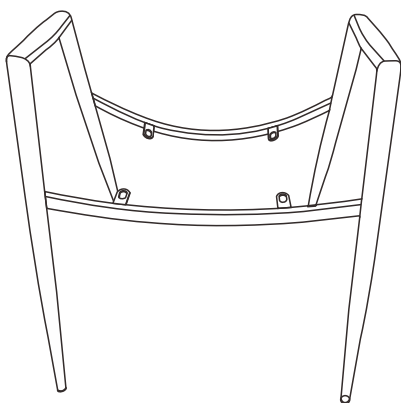

(2)



(3)

- | | | | |
|----|---|----|---------|
| 1. |  | X4 | M6*20mm |
| 2. |  | X4 | |
| 3. |  | X1 | |

INSTRUCTIONS

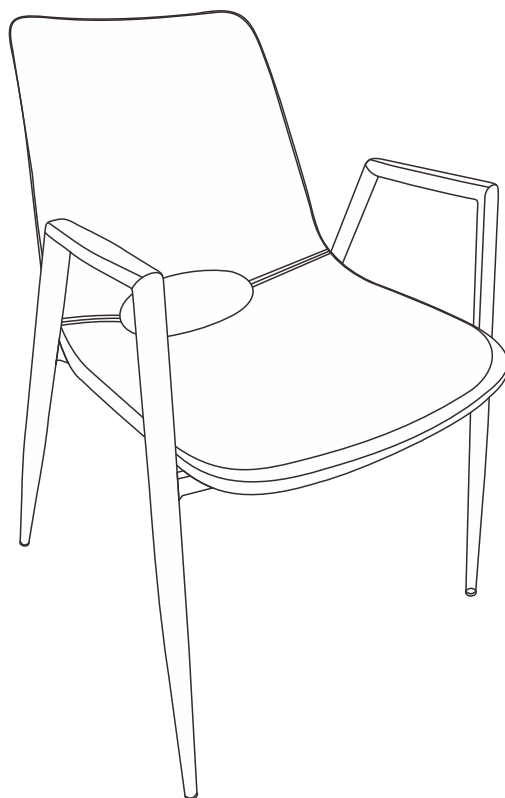
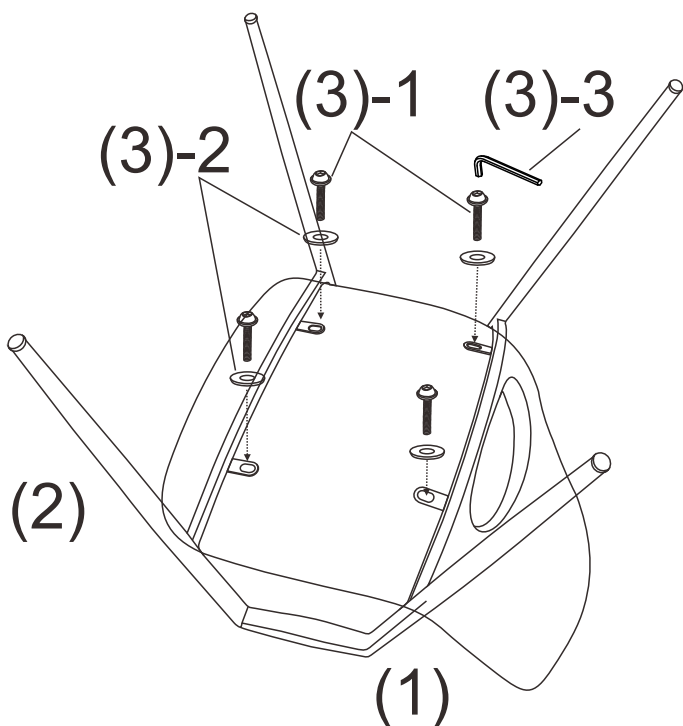

ITEM NAME /NOM D'ITEM:DESI CHAIR
ITEM # /NO. ITEM:101694 (BLACK/NOIR)

Enquiry:parts@zuomod.com

PART LIST/Liste des pièces

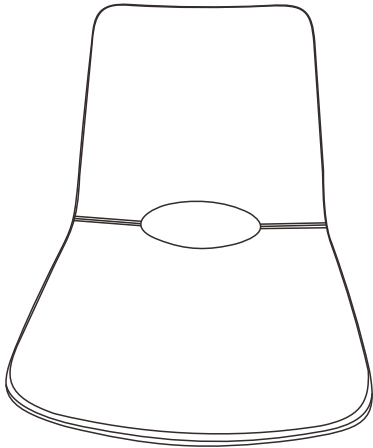

(1)

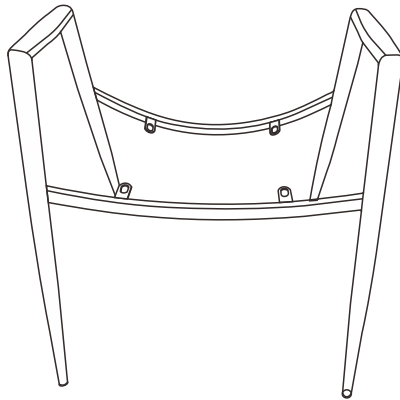

(2)



(3)

- | | | | |
|----|---|----|---------|
| 1. |  | X4 | M6*20mm |
| 2. |  | X4 | |
| 3. |  | X1 | |

INSTRUCTION

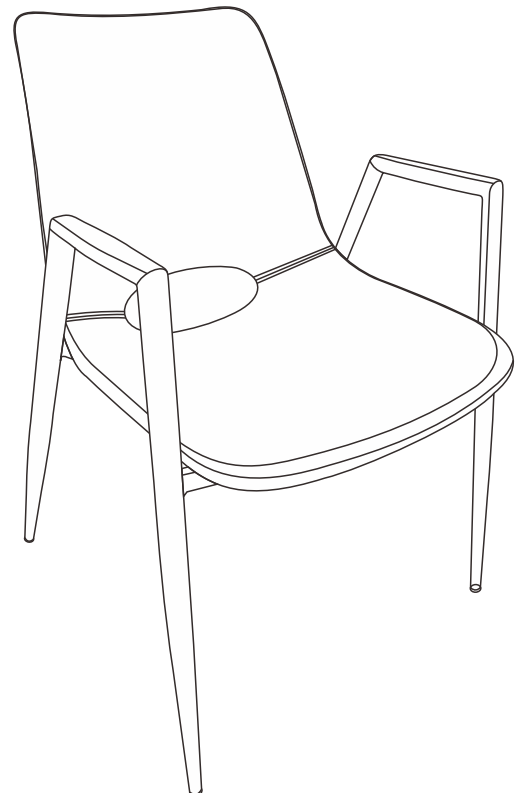
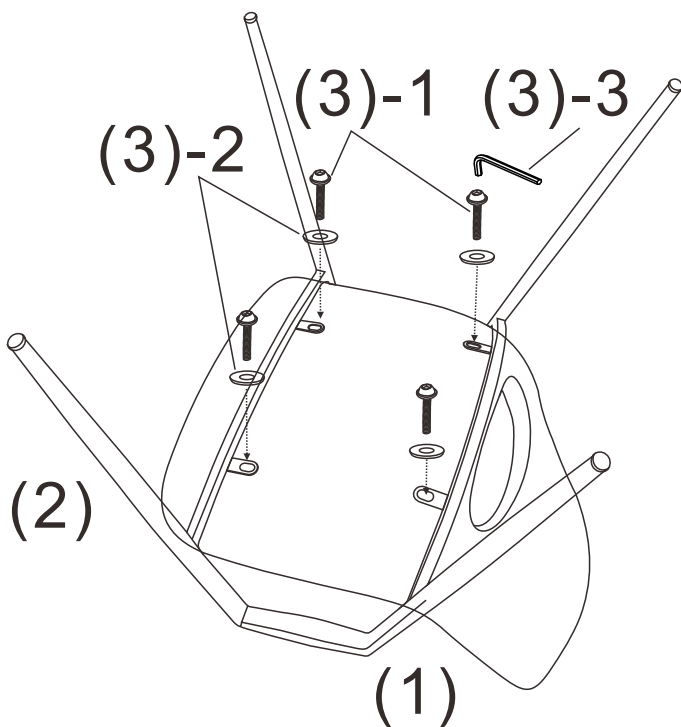

ITEM NAME / NOM D'ITEM : DESI DINING CHAIR

ITEM # / NO. ITEM : 109549 (BLACK & GOLD SS)

Enquiry : parts@zuomod.com

PARTS LIST / Liste des pièces

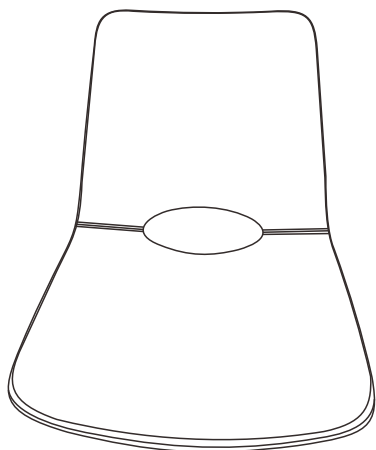

(1)

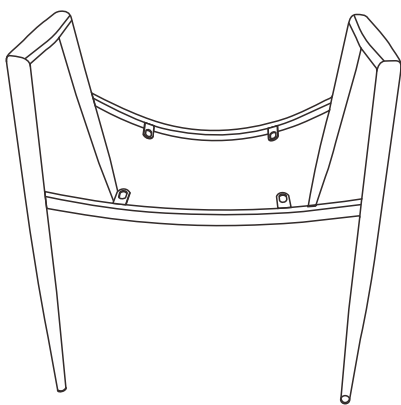

(2)



(3)

- | | | | |
|----|---|----|---------|
| 1. |  | X4 | M6*20mm |
| 2. |  | X4 | |
| 3. |  | X1 | |

INSTRUCTIONS

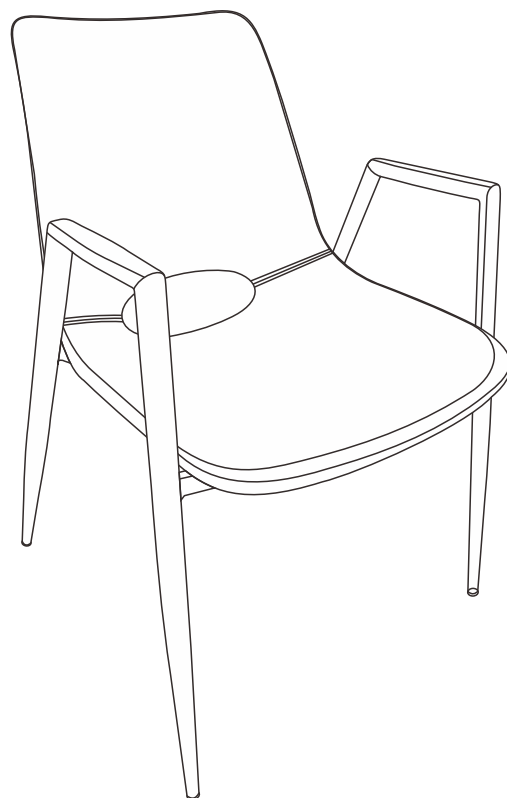
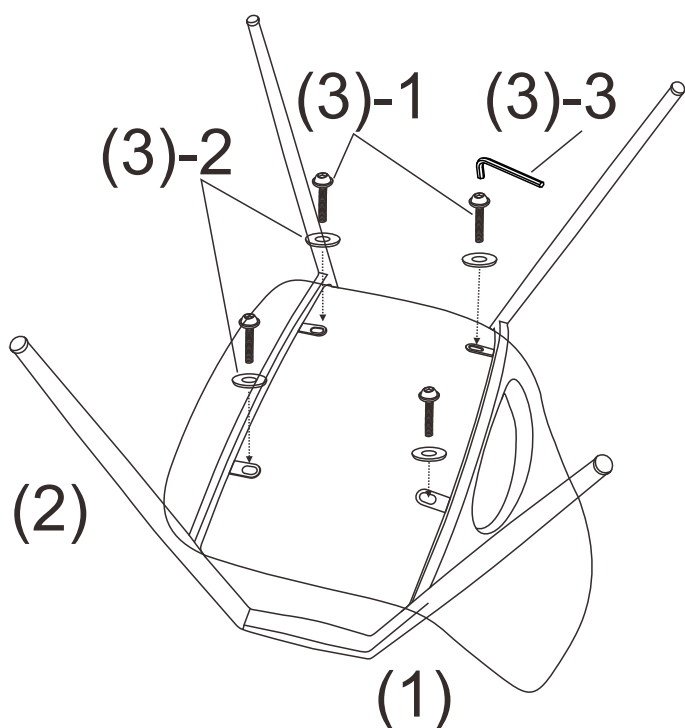

ITEM NAME / NOM D'ITEM : DESI DINING CHAIR

ITEM # / NO. ITEM : 109534 (BLACK & BLACK)

Enquiry : parts@zuomod.com

PARTS LIST / Liste des pièces

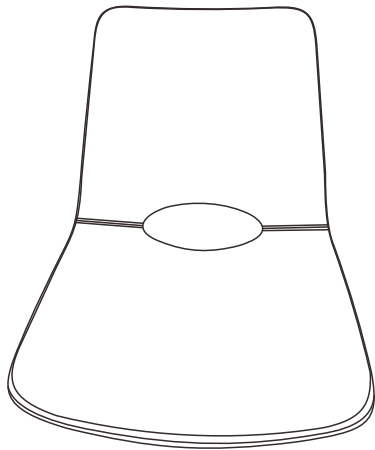

(1)

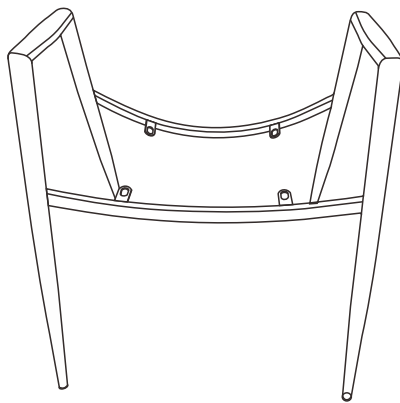

(2)



(3)

- | | | | |
|----|---|----|---------|
| 1. |  | X4 | M6*20mm |
| 2. |  | X4 | |
| 3. |  | X1 | |

INSTRUCTIONS

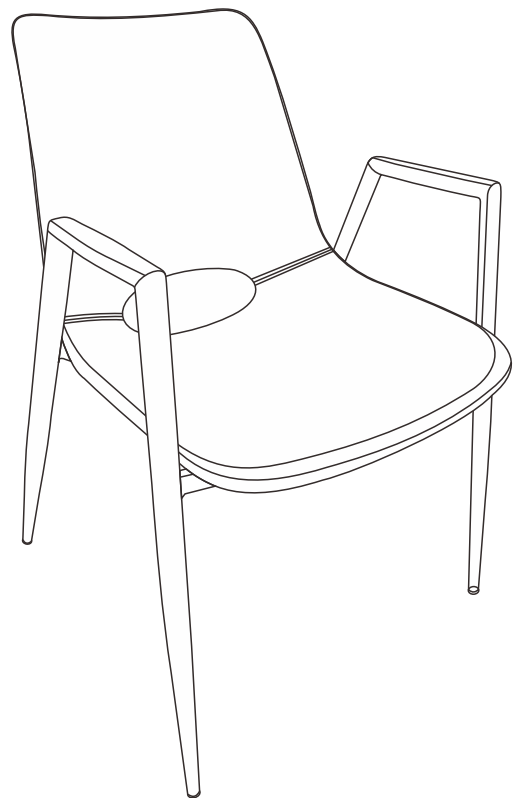
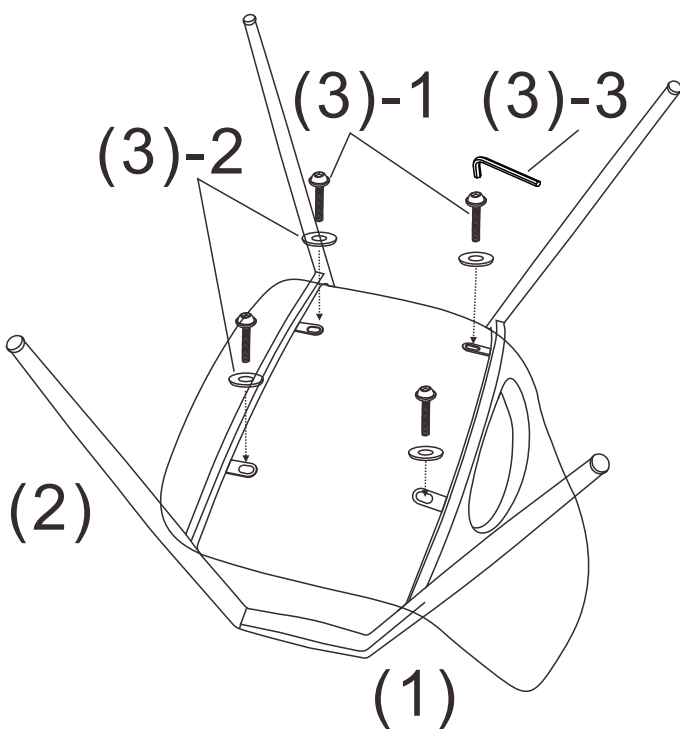

ITEM NAME /NOM D'ITEM:DESI CHAIR

ITEM # /NO. ITEM:101696 (BEIGE)

Enquiry:parts@zuomod.com

PART LIST/Liste des pièces

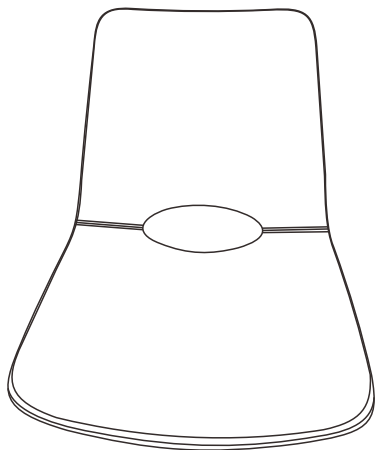

(1)

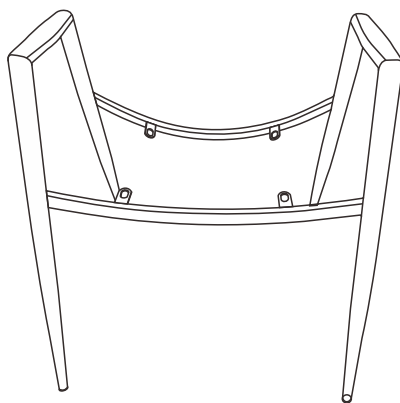

(2)



(3)

- | | | | |
|----|---|----|---------|
| 1. |  | X4 | M5*20mm |
| 2. |  | X4 | |
| 3. |  | X1 | |

INSTRUCTION

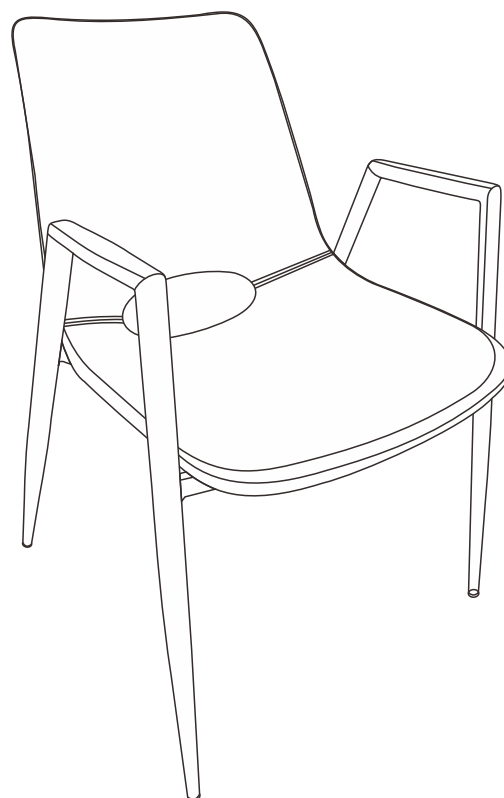
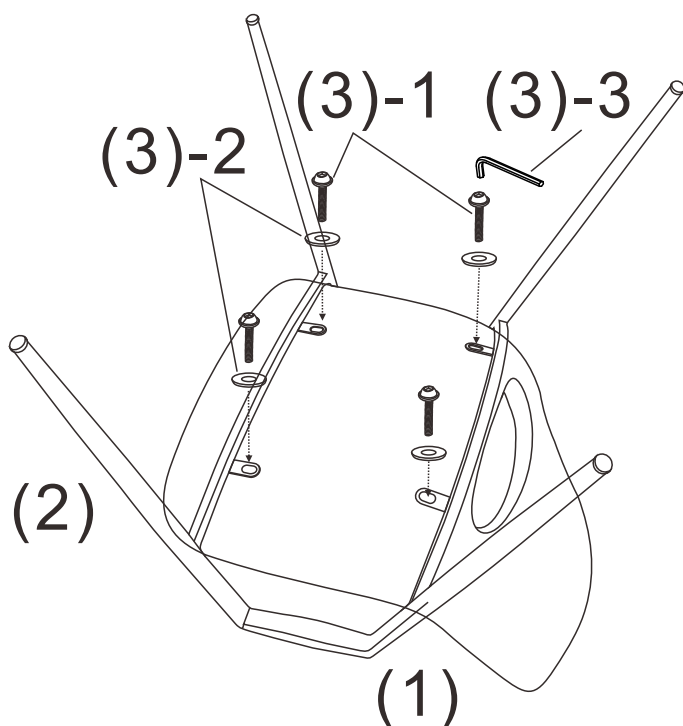

ITEM NAME / NOM D'ITEM : DESI DINING CHAIR

ITEM # / NO. ITEM : 109731 (BEIGE & GOLD)

Enquiry : parts@zuomod.com

PARTS LIST / Liste des pièces

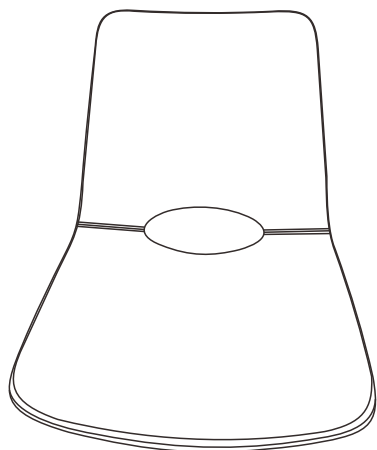

(1)

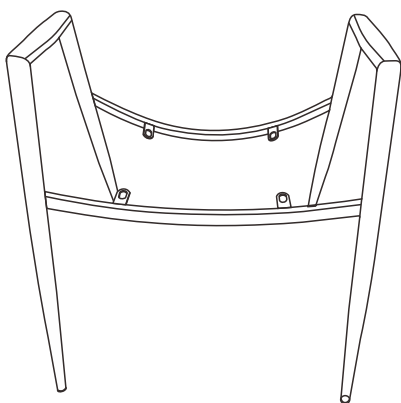

(2)



(3)

- | | | | |
|----|---|----|---------|
| 1. |  | X4 | M6*20mm |
| 2. |  | X4 | |
| 3. |  | X1 | |

INSTRUCTIONS

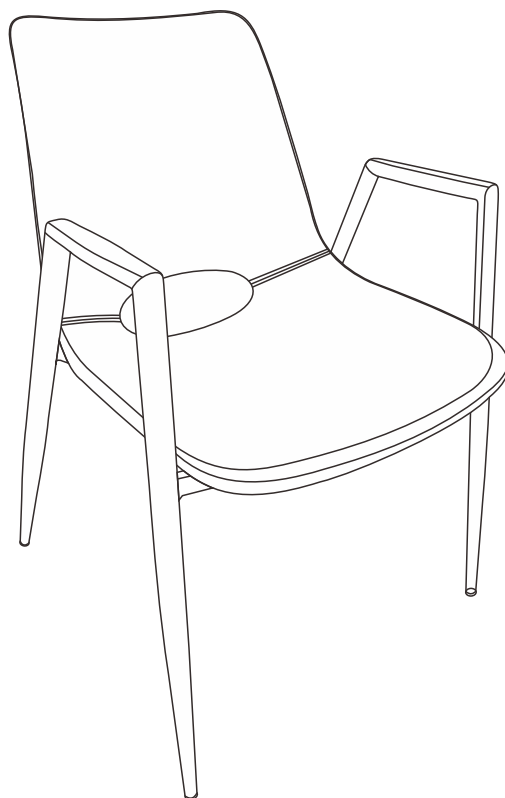
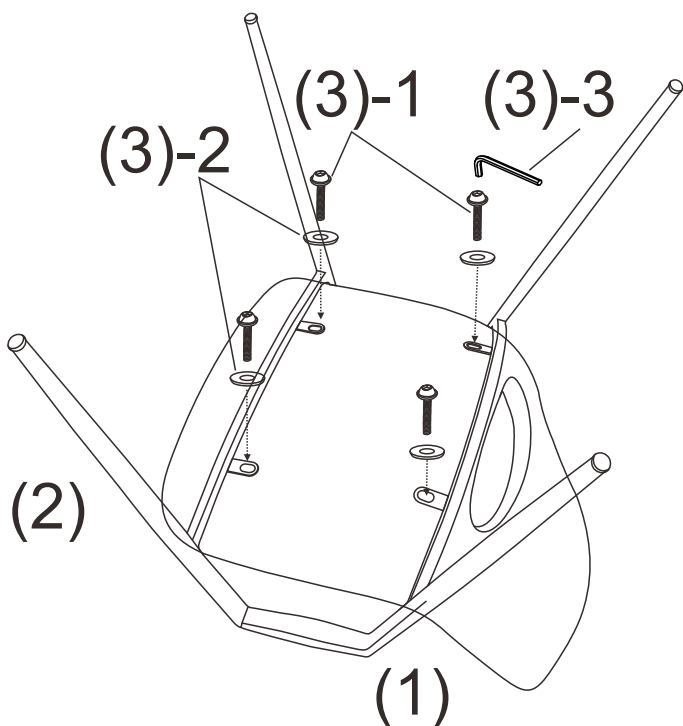

ITEM NAME /NOM D'ITEM:DESI CHAIR

ITEM # /NO. ITEM:101695 (GRAY)

Enquiry:parts@zuomod.com

PART LIST/Liste des pièces

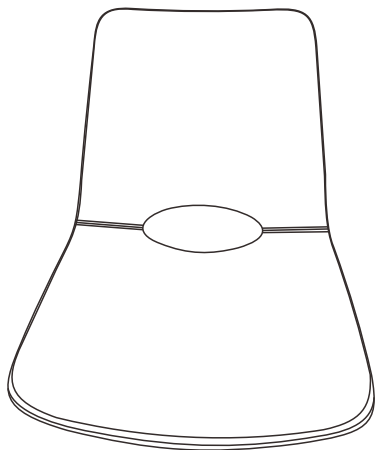

(1)

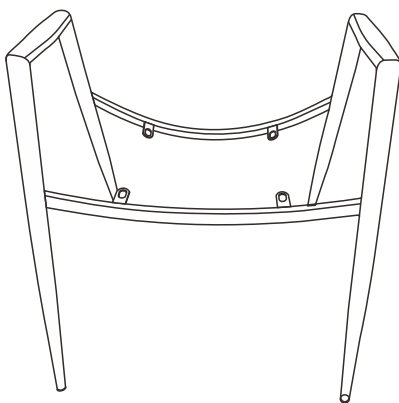

(2)



(3)

- | | | | |
|----|---|----|---------|
| 1. |  | X4 | M5*20mm |
| 2. |  | X4 | |
| 3. |  | X1 | |

INSTRUCTION

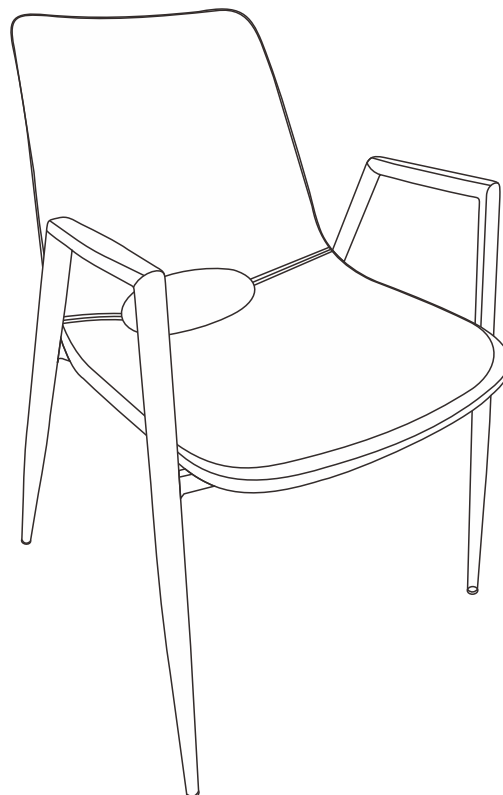
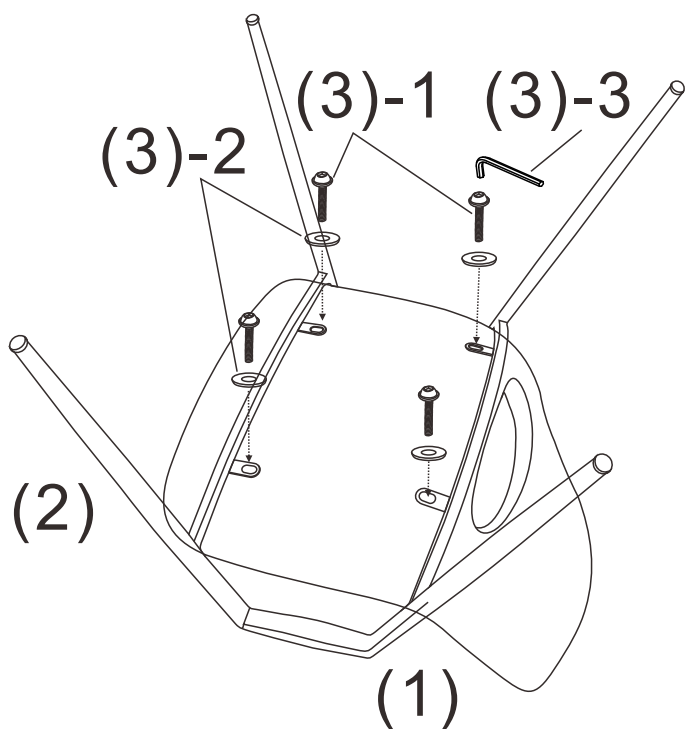

ITEM NAME / NOM D'ITEM : DESI DINING CHAIR

ITEM # / NO. ITEM : 109536 (BLUE & BLACK)

Enquiry : parts@zuomod.com

PARTS LIST / Liste des pièces

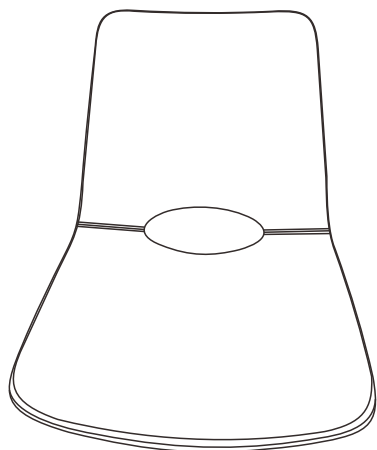

(1)

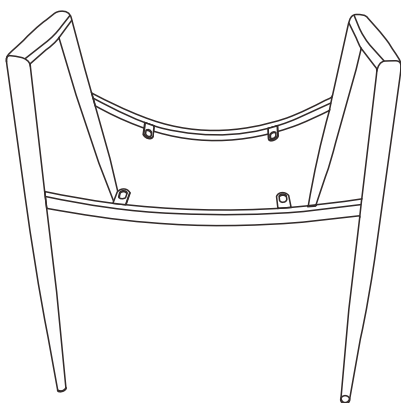

(2)



(3)

- | | | | |
|----|---|----|---------|
| 1. |  | X4 | M6*20mm |
| 2. |  | X4 | |
| 3. |  | X1 | |

INSTRUCTIONS

