

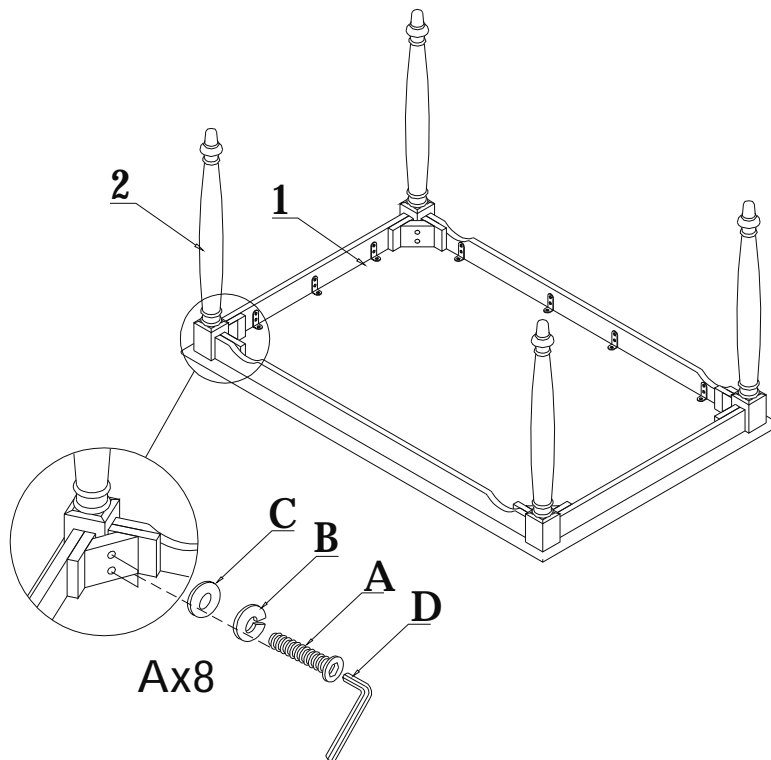

Thank you for purchasing this quality product. Be sure to check all packing material carefully for small parts which may have come loose inside the carton during shipment. Identify and count all parts and compare with the Parts List below.



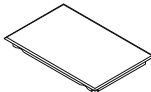

! For items use on wooden floor, hard surfaces or carpets, it is recommended to install protective pads under all legs and supports to avoid/ prevent from damages/ scratches and discoloration.

! Pour les articles Utilisés sur un plancher en bois, des surfaces dures ou tapis, il est recommandé d'installer des mordaches de protection sous tous les jambes et prend en charge pour éviter/empêcher de dommages/raures et la décoloration.



MADE IN VIETNAM

PARTS LIST			
NO.	DRAWING	Q'TY	DESCRIPTION
1		1	TABLE TOP
2		4	TABLE LEG

HARDWARE LIST			
NO	DRAWING	Q'TY	DESCRIPTION
A		8	Ø5/16"*2-1/4" BOLT
B		8	Ø5/16" SPRING WASHER
C		8	Ø5/16"*19*2mm FLAT WASHER
D		1	5mm ALLEN KEY