

ASSEMBLY INSTRUCTION/ INSTRUCTION D' ASSEMBLAGE

1955F-1 FULL BED HEADBOARD / FOOTBOARD / SLATS / LIT
1955T-3 FULL BED / TWIN BED SIDE RAIL / LONGERONS DE CÔTÉS

Thank you for purchasing this product. Please take time to read and follow the instructions below. Check that you have all parts and hardware before assembly.

Merci d'avoir acheté ce produit de qualité. Veuillez lire et suivre les instructions ci-dessous. Vérifiez avant le montage que vous avez toutes les pièces et fixations.

CAUTION : (1) DO NOT FULLY-TIGHTEN THE NUTS OR BOLTS INITIALLY UNTIL ALL THE NUTS AND BOLTS ARE IN PLACE. (TO AVOID CAUSING DAMAGES TO THE THREAD, DO NOT OVER-TIGHTEN THE NUTS OR BOLTS.)









(2) KEEP ALL HARDWARE PARTS OUT OF REACH OF CHILDREN.



It is recommended to install protective pads under all legs and supports to avoid damage or scratches when placing furniture on a wood floor or other hard surface, and to limit indentation and prevent discoloration if placing on carpet.



Il est recommandé de placer des coussins protecteurs sous tous les pieds et toutes les bases des meubles pour éviter d'endommager ou d'égratigner les planchers en bois ou autres surfaces dures, et pour limiter l'empreinte et empêcher la décoloration quand les meubles reposent sur la moquette.

Hardware List (PACK INSIDE HEADBOARD / FOOTBOARD / SLATS)			
NO.	Descriptions		Qty.
1	JCBC Screw M6 x 40mm / Vis		6
2	Spring Washer M6 / Rondelle D'Arret		6
3	Flat Washer 1/4 / Rondelle Plate		6
4	M4 Allen Key / Cle'allen		1
5	Screw 1/4 P/H Rattan 8x1 / Vis		6
6	M5 Allen Key / Cle'allen		1
7	JCBC Screw M8 X 25MM / Vis		8
8	Spring Washer 5/16" / Rondelle D'Arret		8
9	Flat Washer 5/16"X1MM / Rondelle Plate		8

Component List		
NO.	Descriptions	Qty.
A	Headboard / Tete De Lit	1
B	LSF Post / Poteau	1
C	RSF Post / Poteau	1
D	Footboard / Pied De Lit	1
E	Side Rails / Longerons De Côtés	2
F	Slats / Lattes	3
G	Slat Support / Support Pour Transverses	3

* HARDWARE SET ARE IN 1955F-1

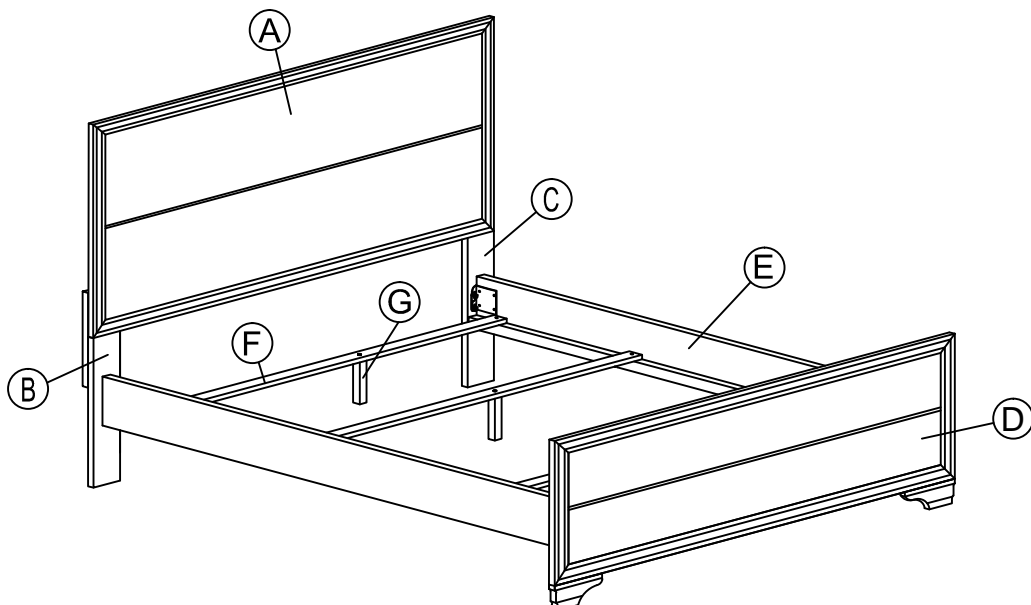

ASSEMBLY INSTRUCTION/ INSTRUCTION D' ASSEMBLANGE

1955F-1 FULL BED HEADBOARD / FOOTBOARD / SLATS / LIT
1955T-3 FULL BED / TWIN BED SIDE RAIL / LONGERONS DE CÔTÉS

COMPLETED ASSEMBLY

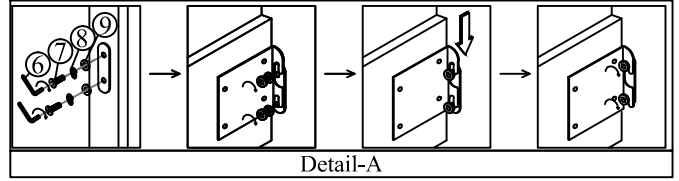

STEP 1 / ETAPE 1:

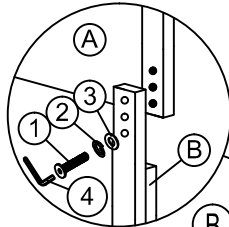

STEP 2 / ETAPE 2

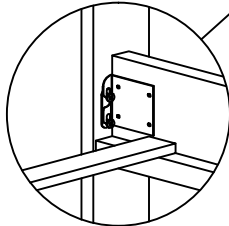

Detail-A

STEP 4 / ETAPE 4:

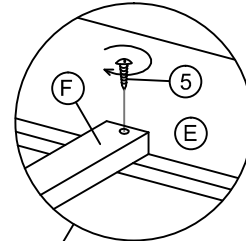

STEP 3 / ETAPE 3:

