

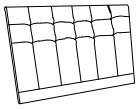

ASSEMBLY INSTRUCTION

HOMELEGANCE 1890KN-1EK EASTERN KING BED HEADBOARD, 100% POLYESTER
1890KN-2EK EASTERN KING BED FOOTBOARD, 100% POLYESTER
1890KN-3EK EASTERN KING BED RAILS & SLATS, 100% POLYESTER

PART LIST: (NOTE:HARDWARE PACK INSIDE THE CARTON OF 1890KN-3EK)



A: Headboard
1PC

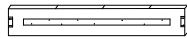

B: Rail
2PCS

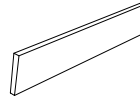

C: Footboard
1PC



D: Slat
3PCS

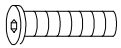

E: Bolt M8*30mm
8PCS



F: Metal Support
Leg 3PCS



G: Plastic Leg
4PCS



H: Center Metal
Support Rail 1PC

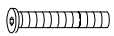

I: Bolt 1/4*48mm
6PCS



J: Nut 1/4
6PCS

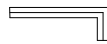

K: Allen Key 5mm
1PC



L: Allen Key 4mm
1PC

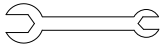

M: Wrench 1/4*35mm
1PC

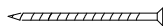

N: Screw 4.0*60mm
8PCS



O: Lock Washer
8PCS



P: Flat Washer
8PCS



Q: Bolt 1/4*15mm
3PCS

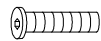

R: Bolt M6*30mm
4PCS

NOTE: PLEASE DO NOT TIGHTEN ALL BOLTS UNTIL THE BED IS ASSEMBLED COMPLETELY.

STEP 1

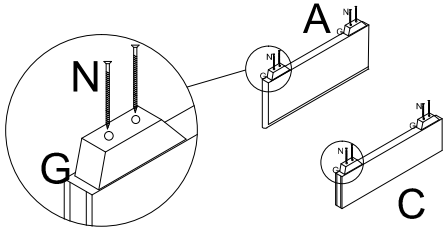

STEP 2

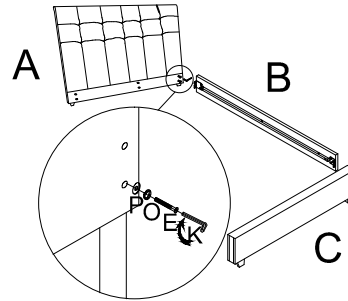

STEP 3

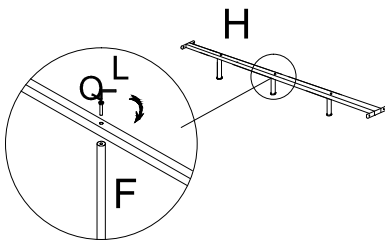

STEP 4

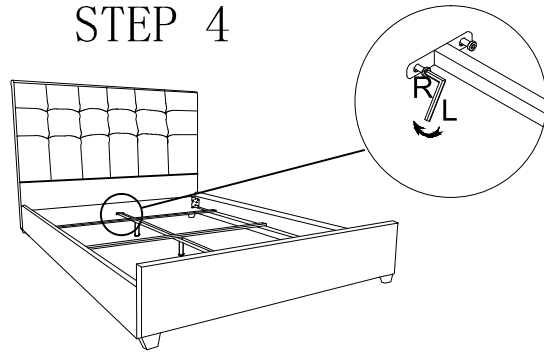

STEP 5

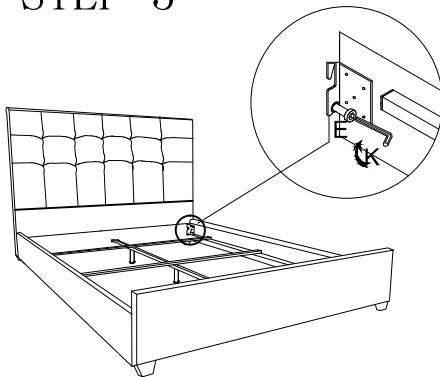

STEP 6

