

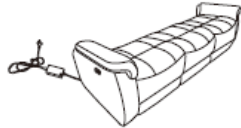







Assembly Instruction
POWER DOUBLE RECLINING SOFA
WITH POWER HEADRESTS, DROP DOWN
CUP HOLDERS, RECEPTACLES & USB PORTS
ITEM NO.: 9848BR-3PWH/9848GY-3PWH

NOTE: Do not use power tools for assembly. Power tools increase the risk of over tightening which leads to splitting or cracking the wood.

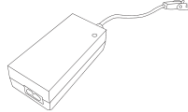
COMPONENT LIST (SOFA)

NO.	DRAWING	QTY	DESCRIPTION
A		1	SEAT FRAME
B		1	LSF BACK REST
C		1	MIDDLE BACK REST
D		1	RSF BACK REST
E		1	ADAPTER
F		1	PLUG WITH WIRE

STEP# 1

Align the female brackets at the back onto the male brackets at the seat, insert back rest to the seat and make sure it is fixed in position securely.

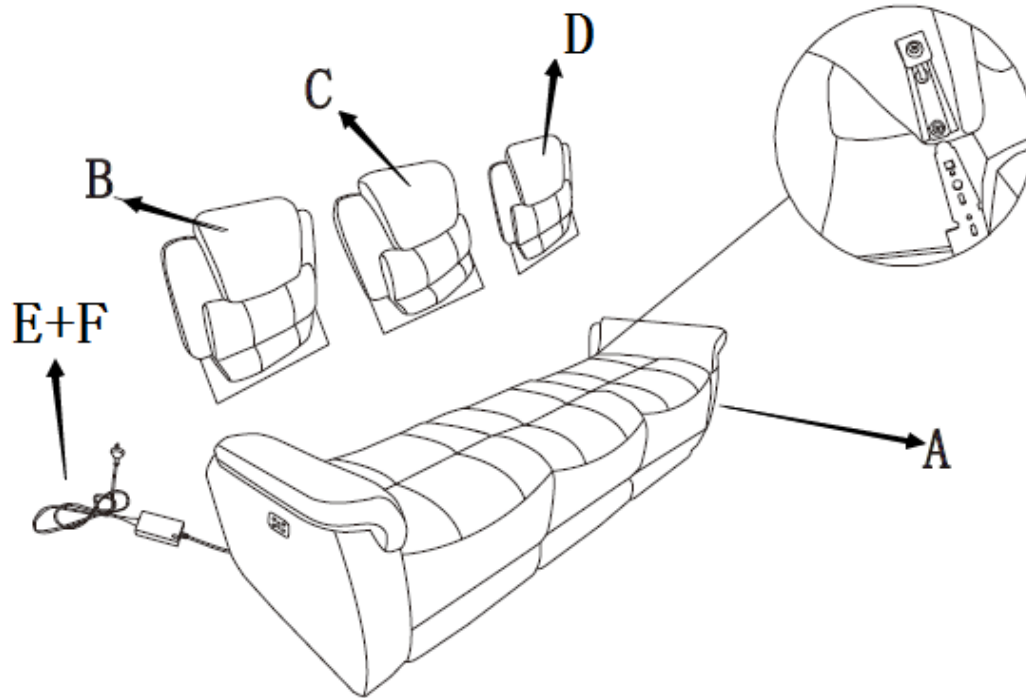

STEP#2

Attach the adapter and power cord to the position as shown in the drawing properly.

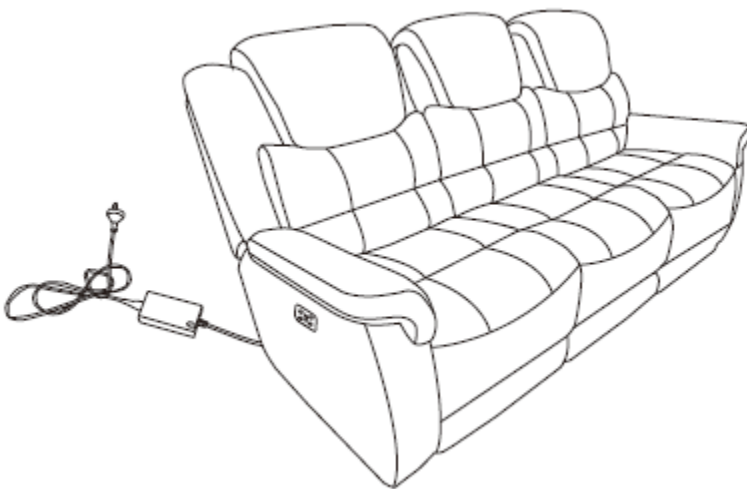

Care Instruction for Polished Microfiber Match Furniture.

In order to maintain the original appearance of your polished microfiber match furniture, please follow below simple care procedures:

- Avoid exposing furniture directly to sunlight or heating and air conditioning outlets. Sunlight and/or exposure to heating and air conditioning outlets will fade/damage fabrics.
- Vacuum or wipe with a soft brush to remove dust.



For items use on wooden floor, hard surfaces or carpets, it is recommended to install protective pads under all legs and supports to avoid/prevent from damages/scratches and discoloration.

Warning

Do not allow electrical cord to be pinched between moving parts or between the frame and the floor. Do not place cord under carpet or in location where it could become worn.