

ASSEMBLY INSTRUCTION









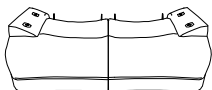

ITEM NO.: 9422FS-2PWH Power Double Reclining Love Seat with Power Headrests and USB Port

 Arms are stored underneath the seat and adaptor set is located on the seat. Please take out for assembly

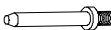
NOTE: Do not use power tools for assembly. Power tools increase the risk of over tightening which lead to splitting or cracking the wood.

COMPONENT LIST

NO.	DRAWING	QTY	DESCRIPTION
A		1	LOVE SEAT
B		1	LSF BACK REST
C		1	RSF BACK REST
D		1	LSF ARM REST
E		1	RSF ARM REST
F		4	METAL PIN $\phi 5/16'' * 2-5/8''$
G		1	WIRE
H		1	ADAPTOR
I		1	PLUG WITH WIRE

STEP 1

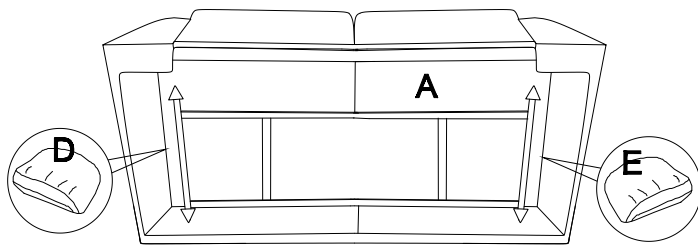

STEP 2

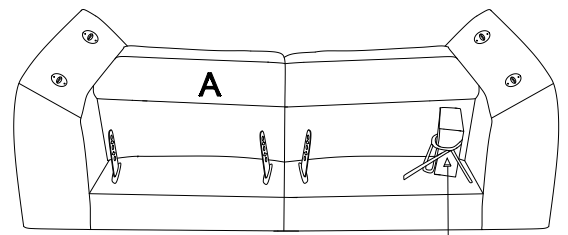

F+G+H+I

STEP 3

Turn clockwise to tighten the metal pin, align and insert metal pin to the arm frame, push forward to lock the pin.

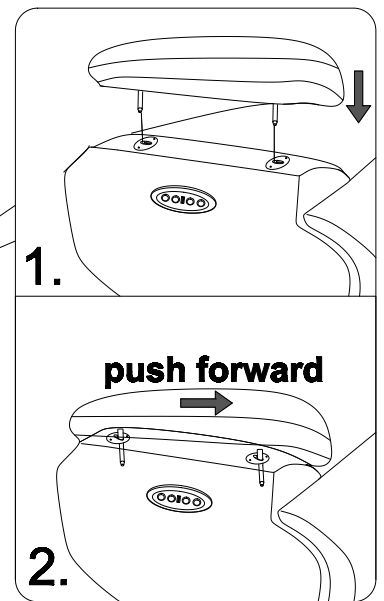
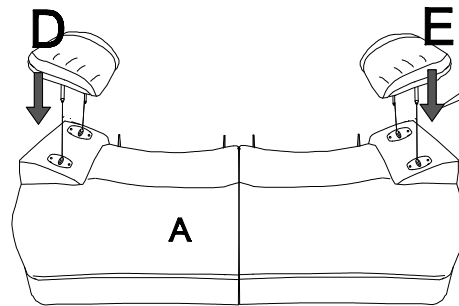
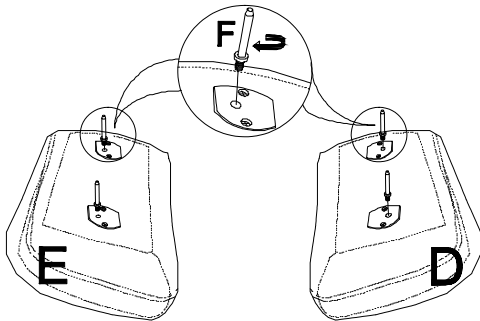

STEP 4

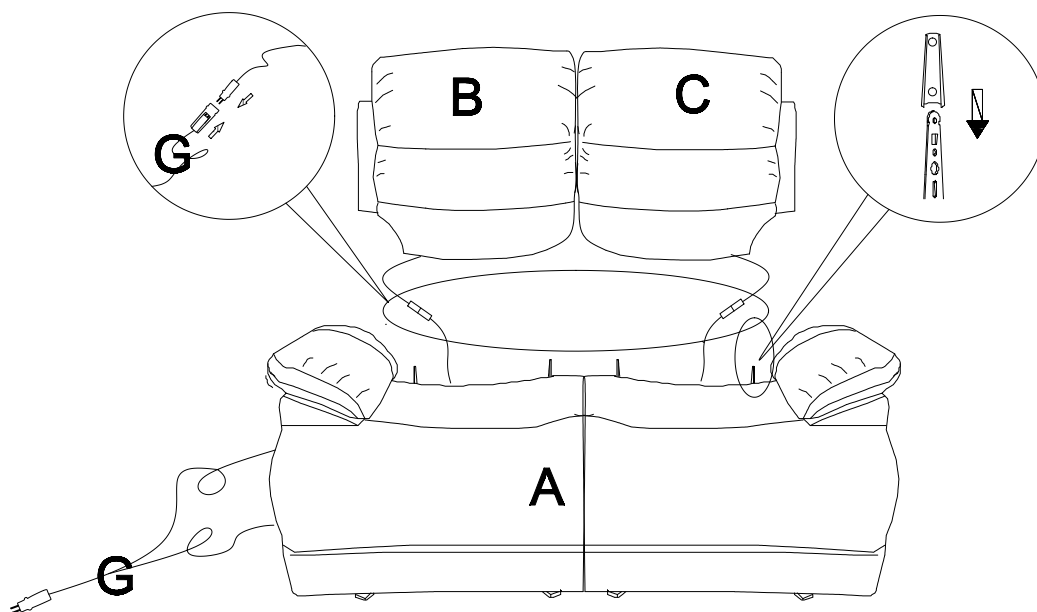

STEP 5

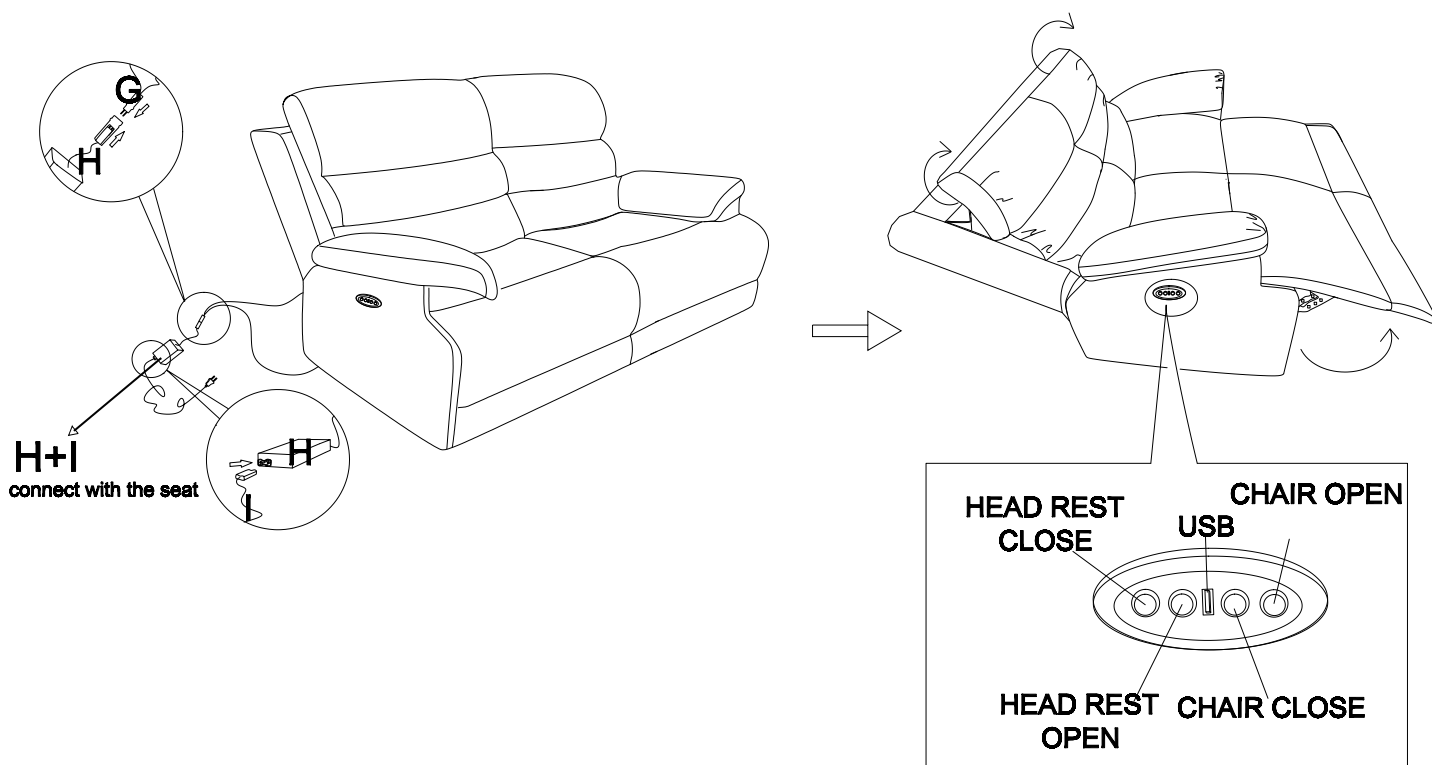

Care instruction for 100% polyester furniture.

In order to maintain the original appearance of your 100% polyester furniture, please follow below simple care procedures:

- Avoid exposing furniture directly to sunlight or heating and air conditioning outlets. Sunlight and or exposure to heating and air conditioning outlets will fade/damage fabric.
- Do not place your upholstered furniture too close to windows, radiators, or vents, and be sure to use windows, radiators, or vents.
- Vacuum or wipe with a cloth regularly to remove dust.



For items used on wooden floor, hard surfaces or carpets, it is recommended to install protective pads under all legs and supports to avoid/prevent from damages/scratches discoloration.

Warning

Do not allow electrical cord to be pinched between moving parts or between the frame and the floor. Do not place cord under carpet or in location where it could become worn.