







Assembly Instruction

ITEM NO: 9590BR/GY-1

Reclining Chair

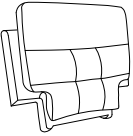
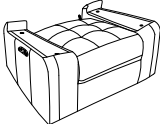
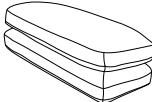
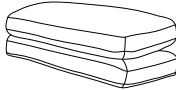
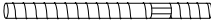
NOTE: Do not use power tools for assembly. Power tools increase the risk of over tightening which lead to splitting or cracking the wood.

PARTS LIST

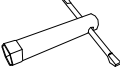
NO.	DRAWING	QTY	DESCRIPTION
A		1	BACK REST
B		1	SEAT
C		1	LSF ARM CUSHION
D		1	RSF ARM CUSHION
E		4	THREAD RODS
F		4	HEX NUTS
G		4	FLAT WASHERS
H		4	LOCK WASHERS
I		1	SPANNER

Please follow the drawings below to assemble the item.

Note: Adaptor and plug wire are tied on the mechanism at the bottom of seat, please take out for assembly

Step 1.

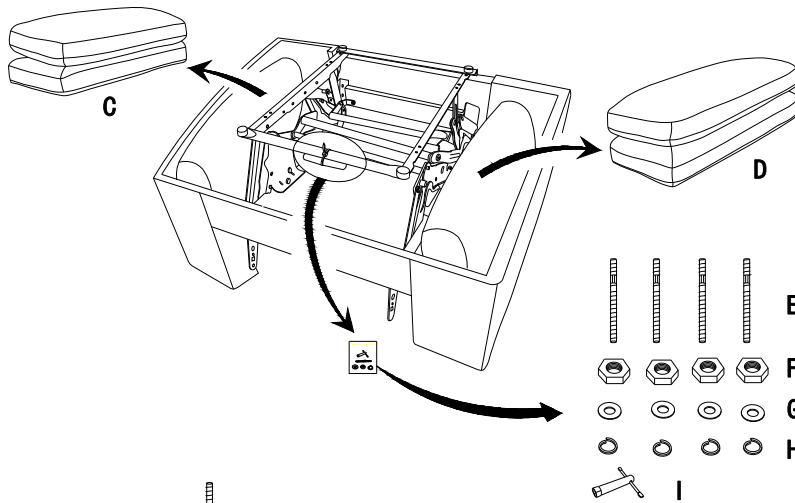

Step 2.

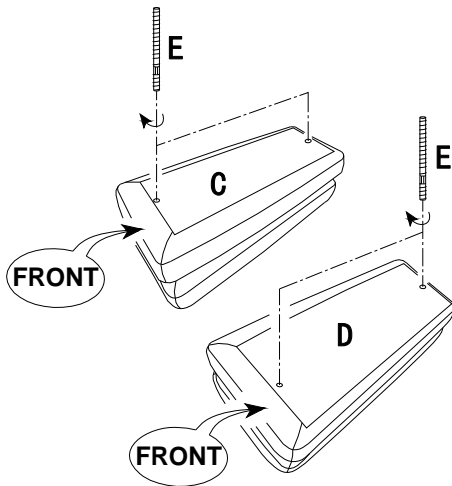

Step 3.

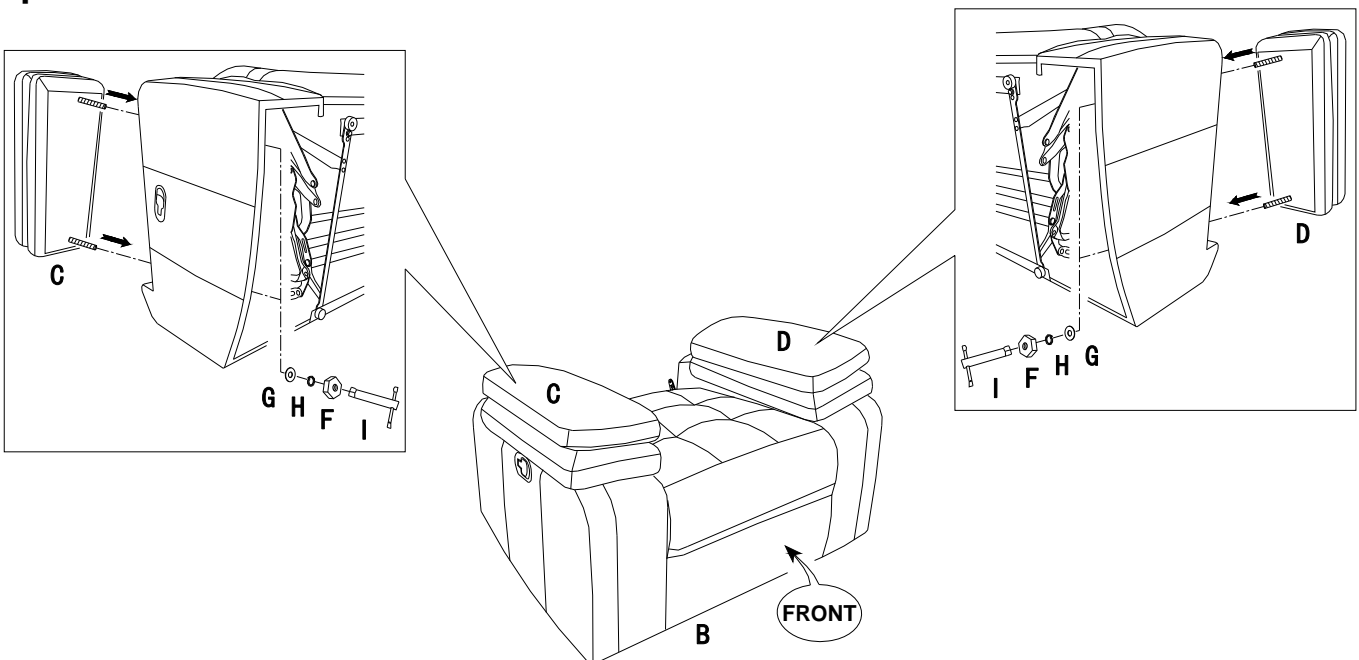

Step 4.

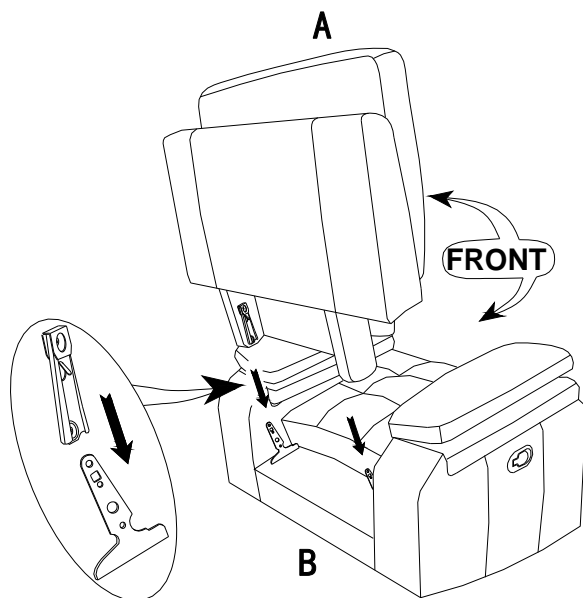

Completed.

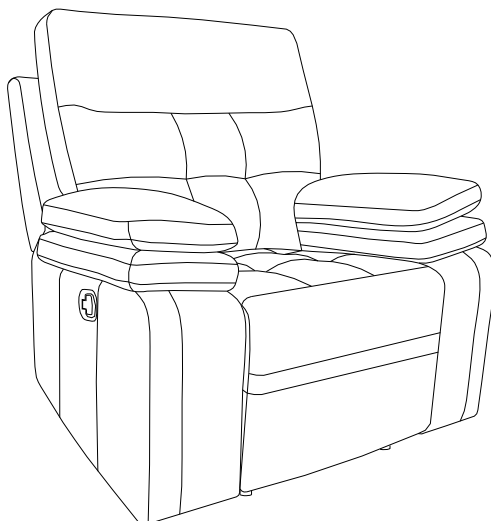

CARE INSTRUCTION FOR LEATHER GEL FURNITURE:

- **Avoid exposing furniture directly to sunlight or heating and air conditioning outlets. Exposure to sunlight or heating and air conditioning outlets will fade/damage Leather gel .**
- **Wipe gently with a damp soft cloth to remove dust, dirt and any grime buildup.**

 **For items use on wooden floor, hard surfaces or carpets, it is recommended to Install protective pads under all legs and supports to avoid/prevent from damages/scratches and discoloration.**