

# Assembly Instruction









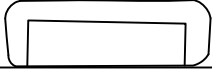
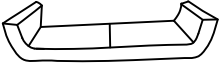

ITEM NO.:8327BE-2/GY-2/TL-2  
LOVE SEAT WITH 2 PILLOWS

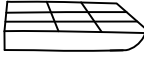

Legs & hardware are stored at the bottom of the unit, please take out the legs and hardware for assembly.

Note: Do not use power tools for assembly. Power tools increase the risk of over tightening which lead to splitting or cracking the wood.

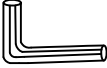
## Component list (Love Seat)

No	Drawing	Qty	Description
A		1	Back rest
B		1	Seat
C		1	LSF back cushion
D		1	RSF back cushion
E		1	LSF seat cushion
F		1	RSF seat cushion
G		4	Wooden Leg
H		8	Bolt
I		2	Pillow
J		1	Allen key
K		8	Washer

Step #1 Please flip over the seat and take out legs & hardware for assembly.

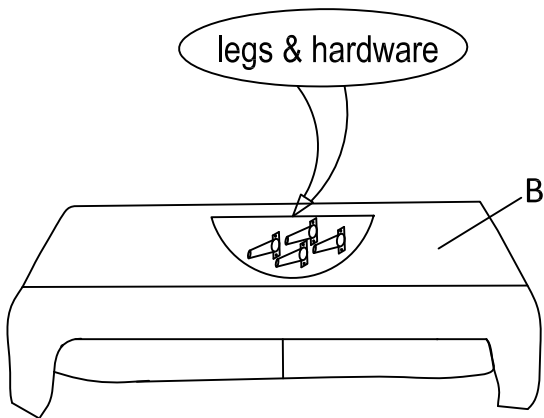

Step #2 Align the legs to the pre-drilled holes, insert the bolts then tighten with Allen key.

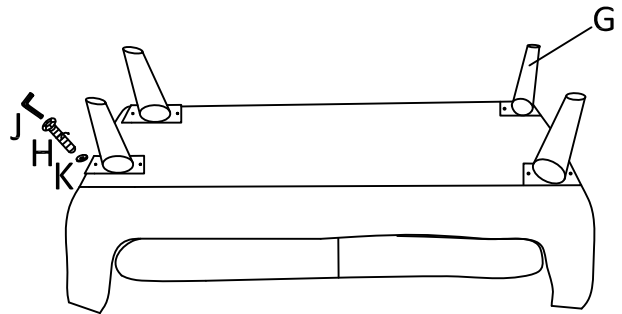

Step #3 Two person assembly is recommended for the back rest. Align both side of male brackets at back rest to be levelled onto the top of the female brackets at inner of seat frame. Insert the back rest and push down slowly to make sure the brackets are connected to each other. Slowly push to the end and make sure back rest is secured in position.

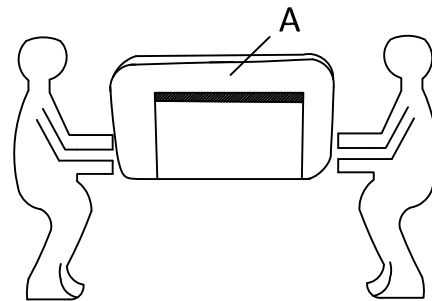
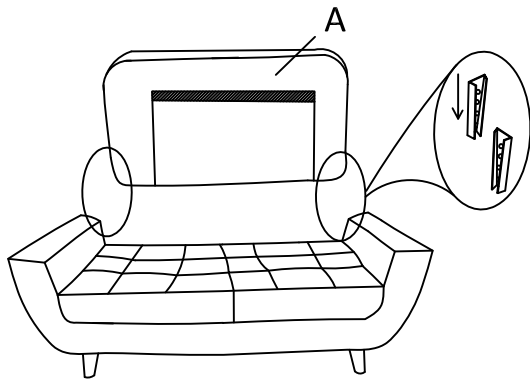

Step #4 Attach the back cushion onto the back rest and fix with velcro properly.

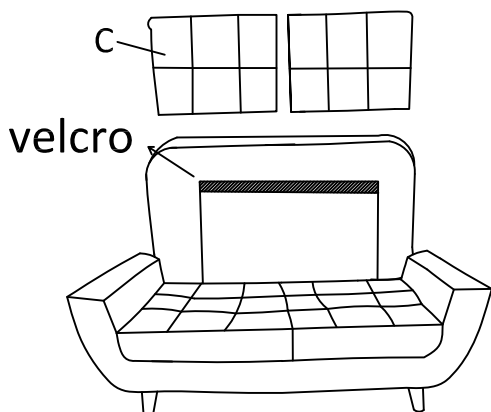

Step #5 Love seat assembly is completed.

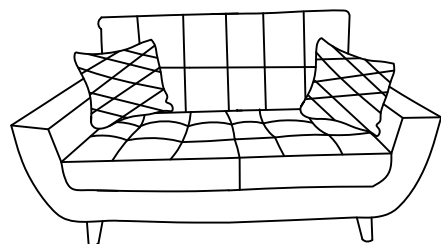

## Care Instruction for Fabric Furniture:

In order to maintain the original appearance of your Fabric Furniture, please follow below simple care procedures:

- Avoid exposing furniture directly to sunlight or heating and air conditioning outlets. Sunlight and or exposure to heating and air conditioning outlets will fade/damage Fabric.
- Vacuum or wipe with a soft cloth to remove dust.
- Clean Fabric with professional cleanser.



For items use on wooden floor, hard surfaces or carpets, it is recommended to Install protective pads under all legs and supports to avoid/prevent from damages/scratches and discoloration.