

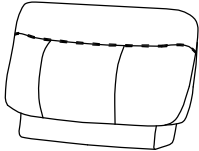
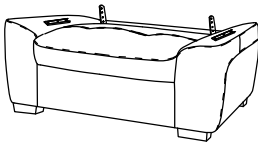
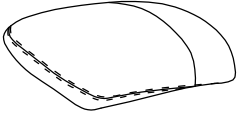
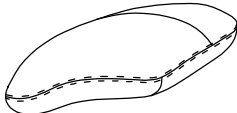
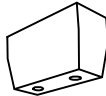

△ It is recommended to install protective pads under all legs and supports to avoid damage or scratches when placing furniture on a wood floor or other hard surface, and to limit indentation and prevent discoloration if placing on carpet.

Il est recommandé de placer des coussins protecteurs sous tous les pieds et toutes les bases des meubles pour éviter d'endommager ou d'égratigner les planchers en bois ou autres surfaces dures, et pour limiter l'empreinte et empêcher la décoloration quand les meubles reposent sur la moquette.

PARTS LIST/ LISTE DE PIÈCES

NO	DRAWING	QTY	DESCRIPTION
A		1	BACK REST
B		1	SEAT
C		1	LSF ARM
D		1	RSF ARM
E		4	PLASTIC LEG

HARDWARE LIST/ LISTE DE QUINCAILLERIE

No	Sketch	Qty	Description
1		8 Pcs	JCBC Screw M6 x 110mm
2		1 Pc	M4 x 100mm Allen Key With Ball

(Step 1)

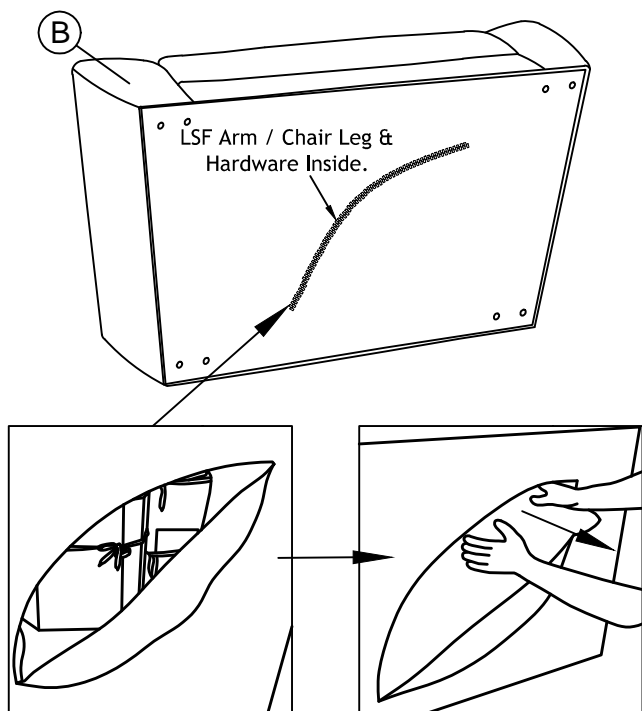

*Take out the LSF Arm / Chair Leg & Hardware.
 *RSF Arm is on the seat.

(Step 2)

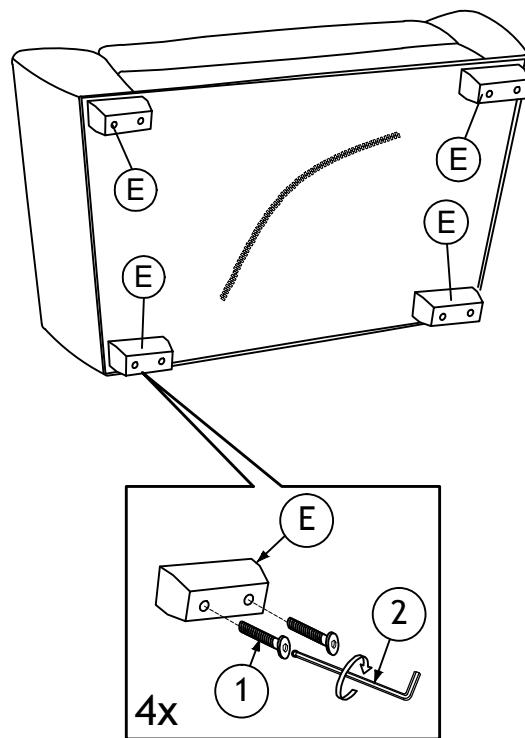

(Step 3)

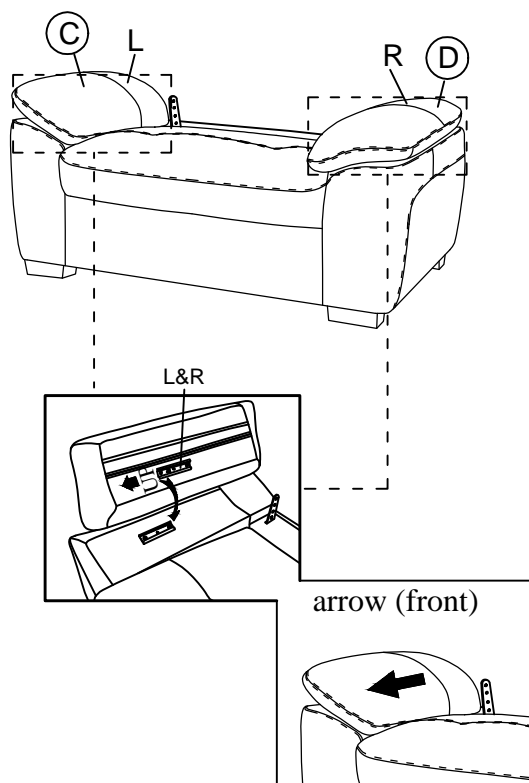

(Step 4)

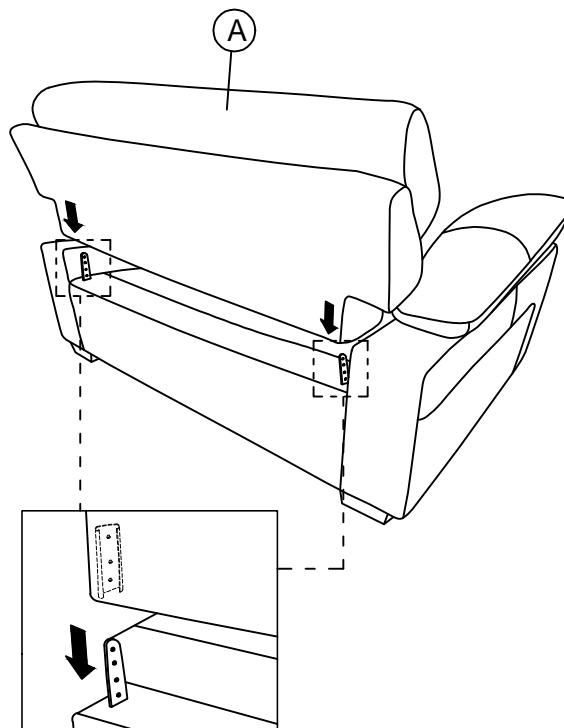

(Step 5) ASSEMBLY COMPLETED

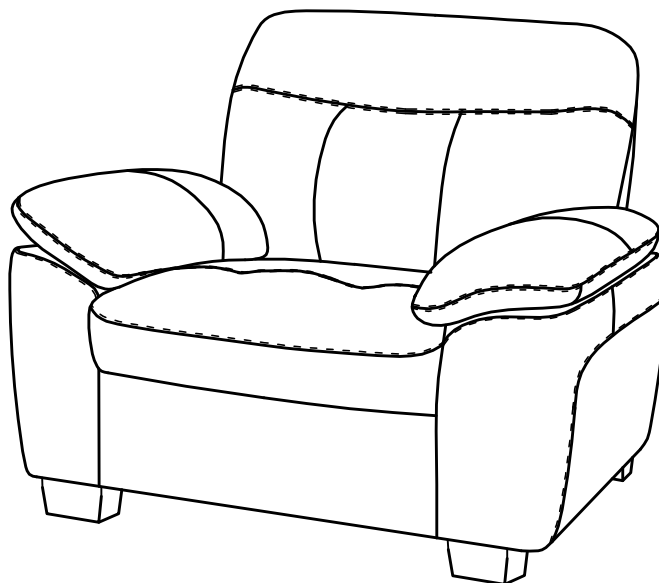

PRODUCT CARE

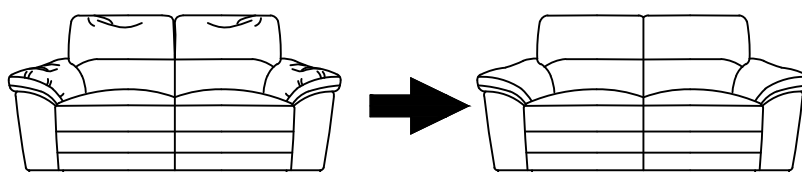
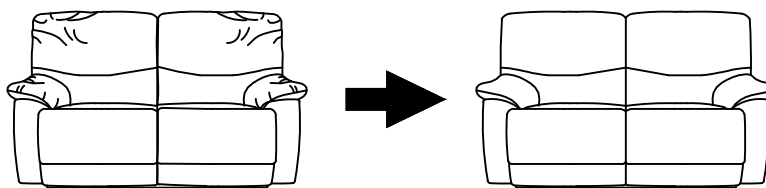

Regular plumping and fluffing is needed to better maintain shape.



Start from the bottom and move to the top.

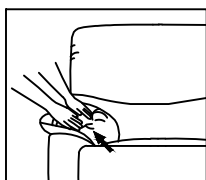

Start center towards to outside border.

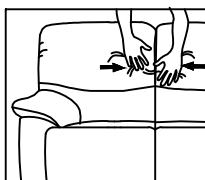

Push left & right backrest cushion to centre gently.

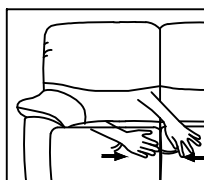

Push left & right seat cushion to centre gently.

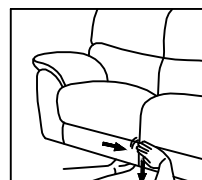

Flapping and align to centre.

CARE INSTRUCTION FOR TOP GRAIN LEATHER MATCH PVC FURNITURE: INSTRUCTIONS POUR LES SOINS DU CUIR ET PVC:

- Avoid exposing furniture directly with sunlight or heating and air conditioning outlets.
- Éviter d'exposer les meubles aux rayons directs du soleil ou aux sorties de chaleur et d'air climatisé.
- Exposure to sunlight or heating and air conditioning outlets will fade/damage top grain leather match PVC.
- Éviter d'exposer les meubles aux rayons directs du soleil ou aux sorties de chaleur et d'air climatisé.
- Wipe gently with a damp soft cloth to remove dust, dirt and any buildup.
- Pour enlever la poussière, essuyer avec un chiffon doux.