









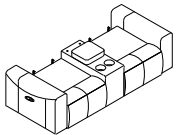

ASSEMBLY INSTRUCTION

ITEM NO.: 9446CB/GY-2PW

Power Double Reclining Love Seat
with Center Console and USB ports

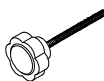
 Adaptor set and hardware are stored in box and place on seat.
Please take out for assembly

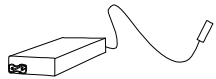
NOTE: Do not use power tools for assembly. Power tools increase the risk of over tightening which lead to splitting or cracking the wood.

NO.	DRAWING	QTY	DESCRIPTION
A		1	LOVESEAT
B		1	LEFT BACK REST
C		1	RIGHT BACK REST
D		1	CONSOLE BACK REST
E		2	BOLT 5/16"*2-3/4"
F		2	FLAT WASHER 5/16"*22
G			Y CABLE
H			ADAPTOR
I			PLUG WITH WIRE

STEP 1:

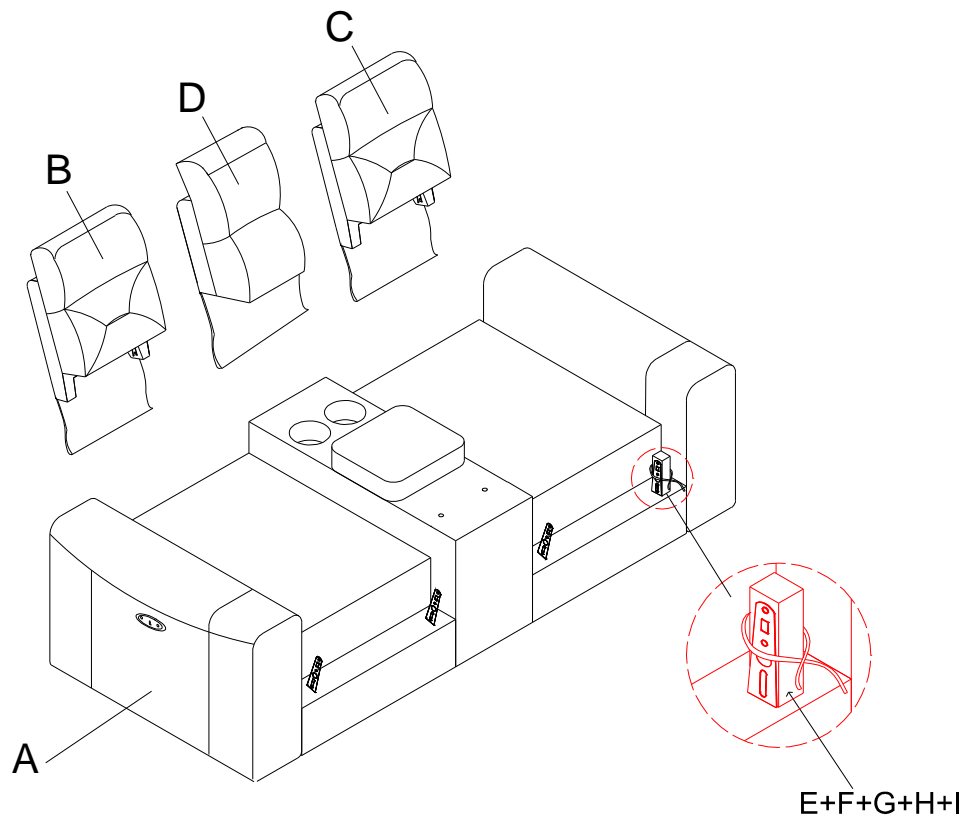

STEP 2:

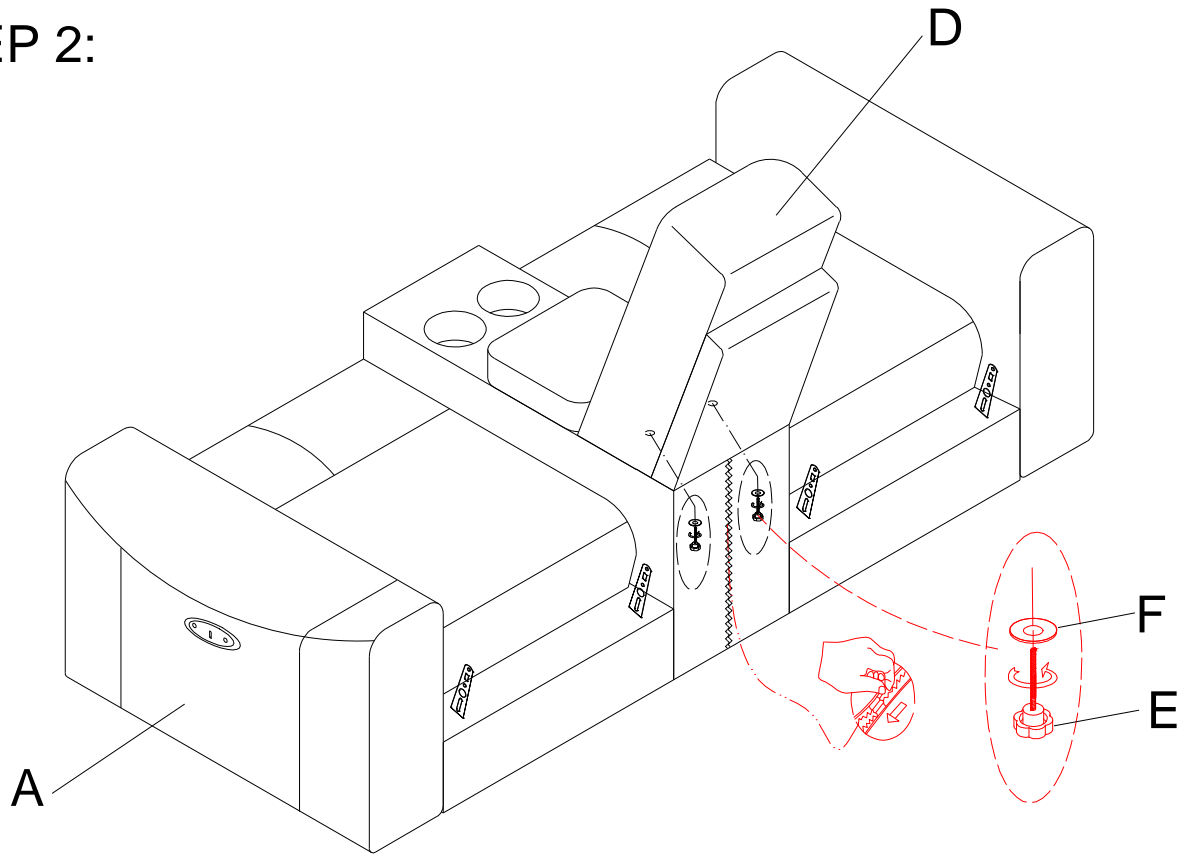

STEP 3:

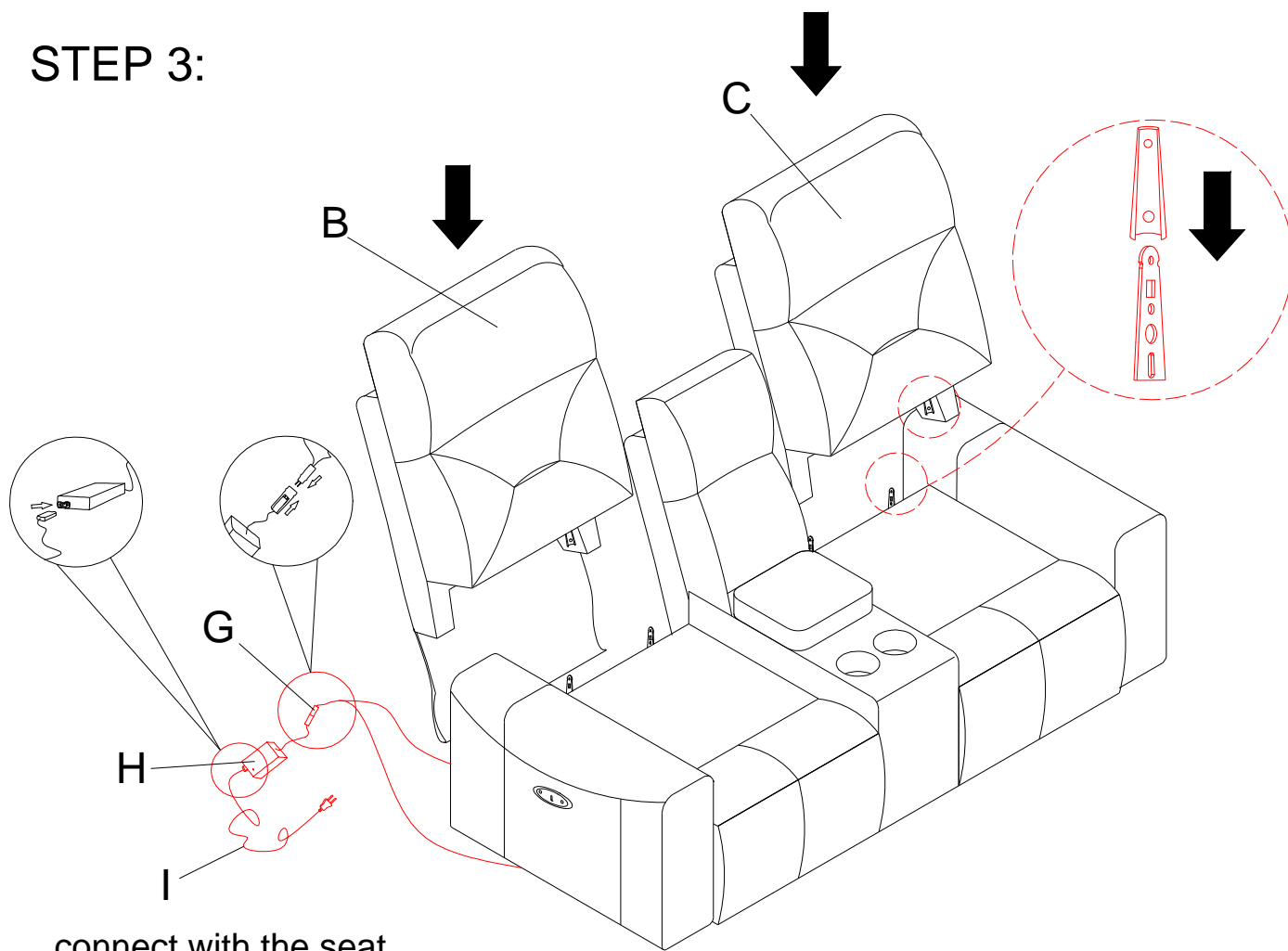

connect with the seat

STEP 4:

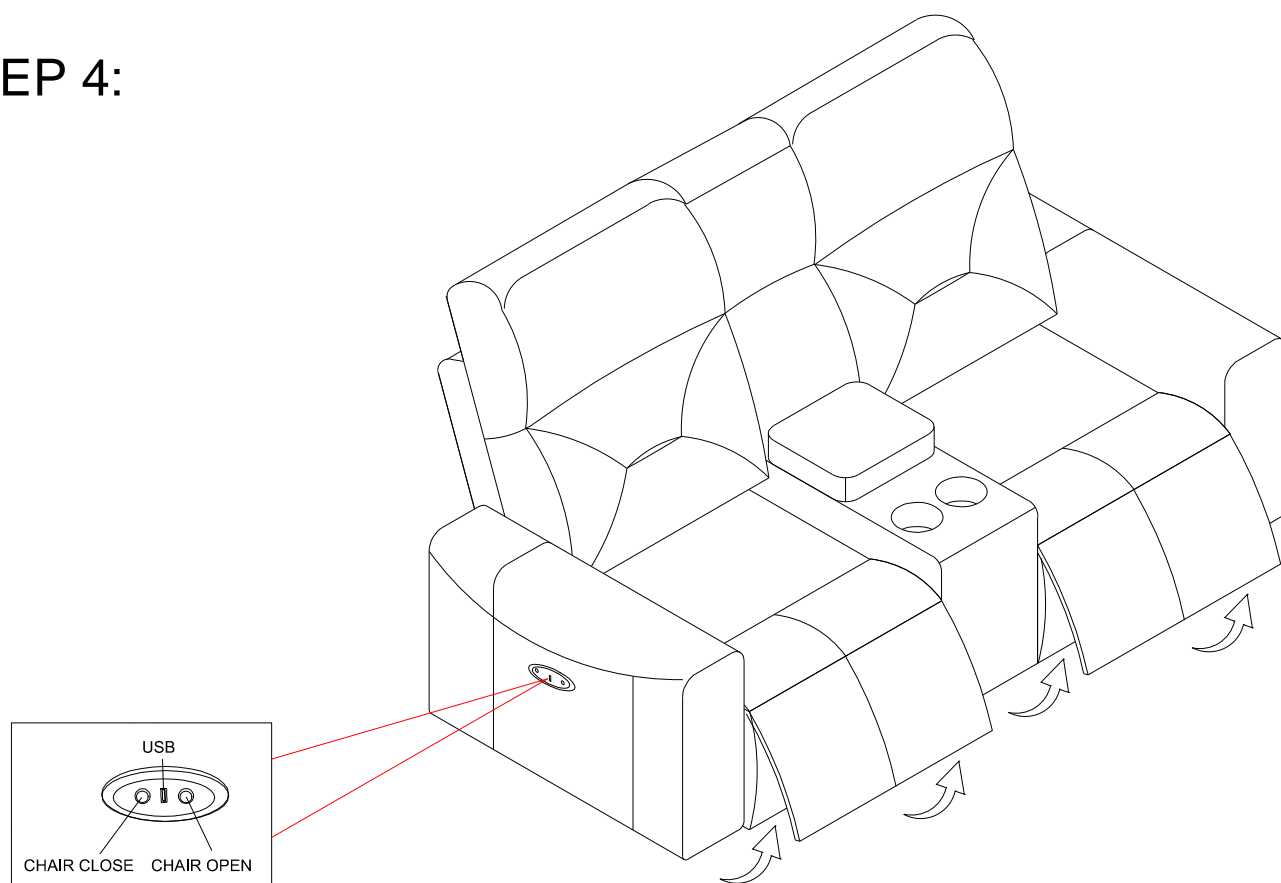

Care instruction for leather gel match furniture.

In order to maintain the original appearance of your leather gel match furniture, please follow below simple care procedures:

- Avoid exposing furniture directly to sunlight or heating and air conditioning outlets. Sunlight and or exposure to heating and air conditioning outlets will fade/damage fabric.
- Do not place your upholstered furniture too close to windows, radiators, or vents, and be sure to use windows, radiators, or vents.
- Vacuum or wipe with a cloth regularly to remove dust.



For items used on wooden floor, hard surfaces or carpets, it is recommended to install protective pads under all legs and supports to avoid/prevent from damages/scratches discoloration.

Warning

Do not allow electrical cord to be pinched between moving parts or between the frame and the floor. Do not place cord under carpet or in location where it could become worn.