







Assembly Instruction

POWER DOUBLE RECLINING LOVE SEAT WITH CENTER CONSOLE, POWER HEADRESTS & USB PORTS,

ITEM NO.: 9849MC-2PWH/9849CH-2PWH

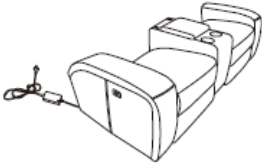
NOTE: Do not use power tools for assembly. Power tools increase the risk of over tightening which leads to splitting or cracking the wood.

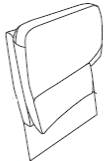
COMPONENT LIST (LOVE SEAT)

NO.	DRAWING	QTY	DESCRIPTION
A		1	SEAT
B		1	LSF BACK REST
C		1	CONSOLE BACK REST
D		1	RSF BACK REST
E		1	ADAPTER
F		1	PLUG WITH WIRE

STEP# 1

Align the female brackets at the back onto the male brackets at the seat, insert back rest to the seat and make sure it is fixed in position securely.

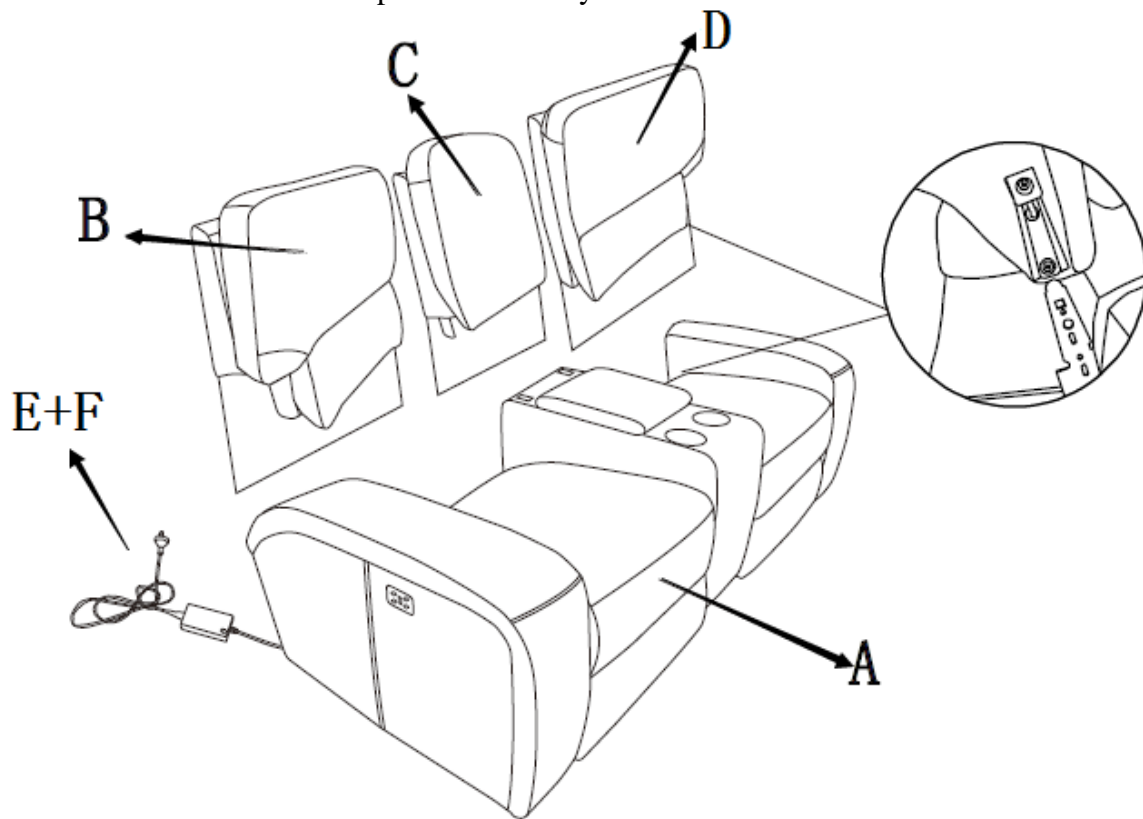

STEP#2

Attach the adapter and power cord to the position as shown in the drawing properly.

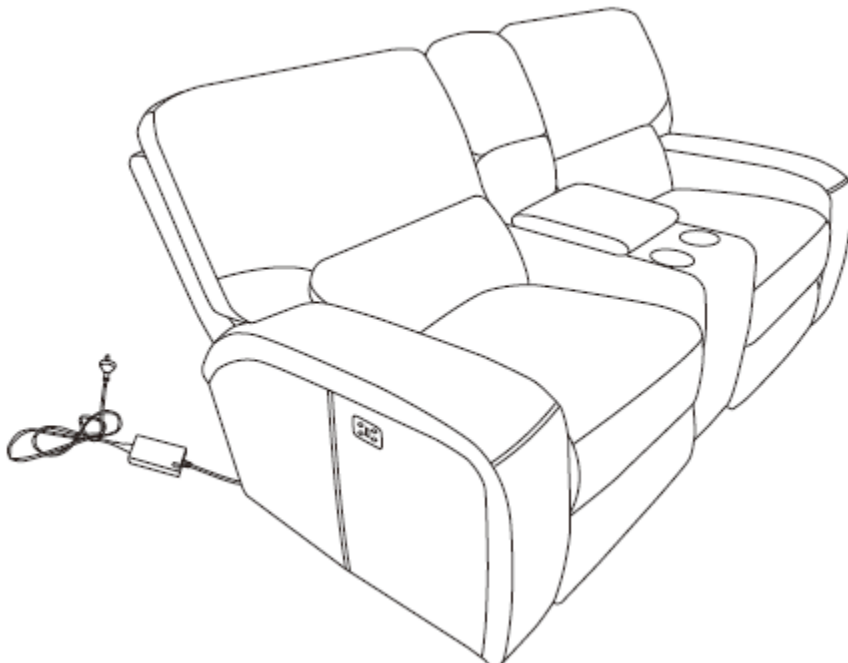

Care Instruction for Polished Microfiber Match Furniture.

In order to maintain the original appearance of your polished microfiber match furniture, please follow below simple care procedures:

- Avoid exposing furniture directly to sunlight or heating and air conditioning outlets. Sunlight and/or exposure to heating and air conditioning outlets will fade/damage fabrics.
- Vacuum or wipe with a soft brush to remove dust.



For items use on wooden floor, hard surfaces or carpets, it is recommended to install protective pads under all legs and supports to avoid/prevent from damages/scratches and discoloration.

Warning

Do not allow electrical cord to be pinched between moving parts or between the frame and the floor. Do not place cord under carpet or in location where it could become worn.