

# Assembly Instruction

ITEM NO.: 9347BU-2









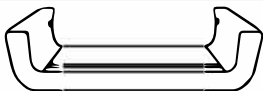
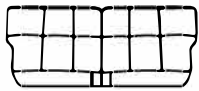

LOVE SEAT



Legs & hardware are stored at the bottom of the seat, please take out for assembly.

Note: Do not use power tools for assembly. Power tools increase the risk of over tightening which lead to splitting or cracking the wood.

## Component list (love seat)

No	Drawing	Qty	Description
A		1	Seat
B		1	Back Rest
C		1	LSF Seat Cushion
D		1	RSF Seat Cushion
E		4	Wooden Leg
F		2	Bolt M8*60mm
G		8	Bolt M8*25mm
H		8	Washer M8
I		2	Washer ø30mm
J		1	Allen Key
K		2	Pillow

**Step #1** Two person assembly is recommended for the back rest. Align both side of male brackets at back rest to be levelled onto the top of the female brackets at inner of seat frame. Insert the back rest and push down slowly to make sure the brackets are connected to each other. Slowly push to the end and make sure back rest is secured in position. Male bracket is for the back rest, female bracket is for the seat.

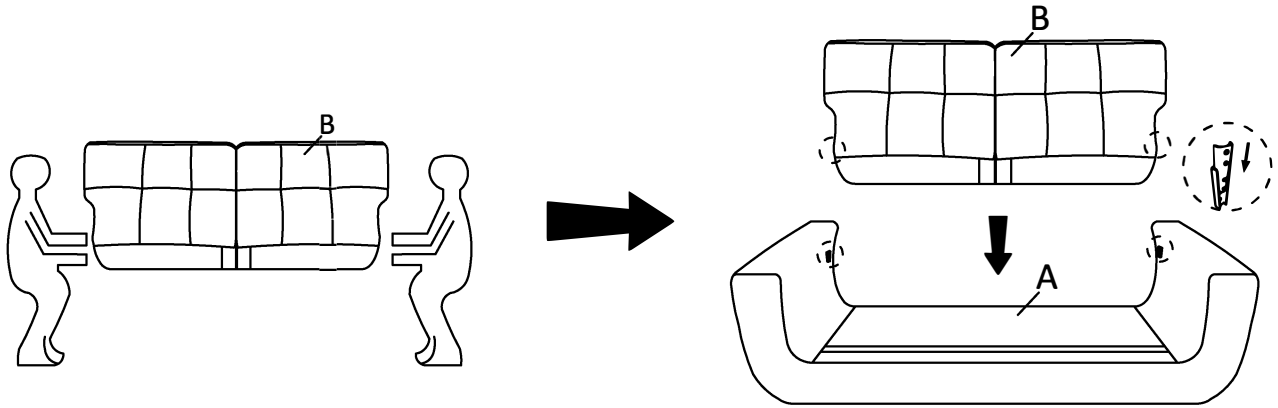

**Step #2** Please lay down the back rest and take out legs and hardware for assembly. Align and insert the bolts go through the seat, tighten with Allen key.

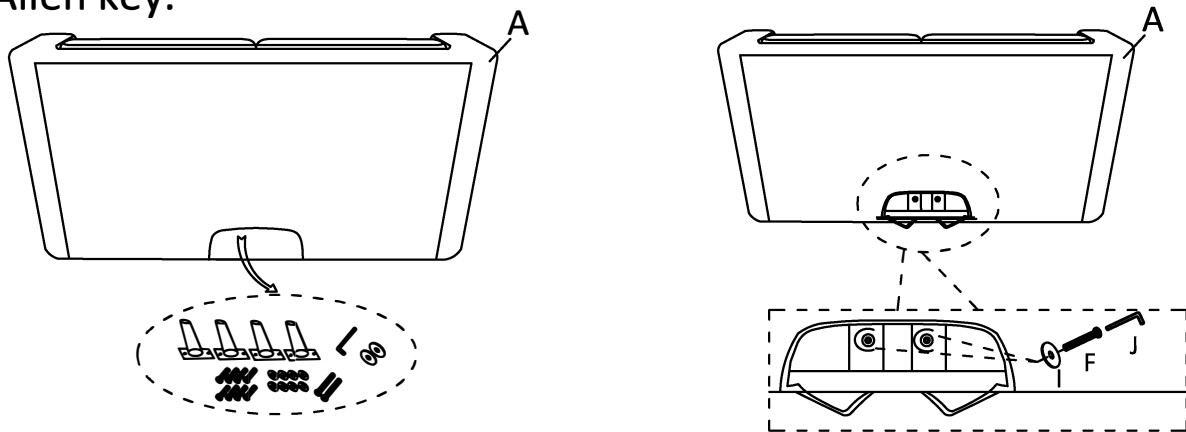

**Step #3** Align the legs to the pre-drilled holes , insert the bolts then tighten with Allen key.

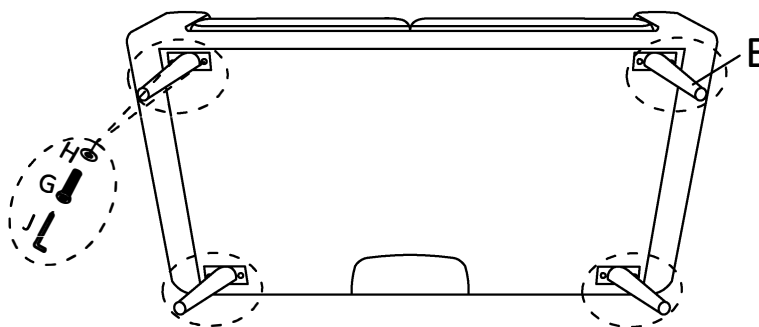

Step #4 Attach the seat cushion & pillow onto the seat and fix with velcro properly.

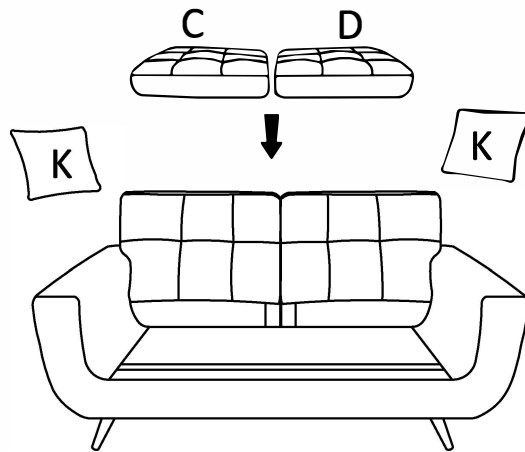

Step #5 Love seat assembly is completed.

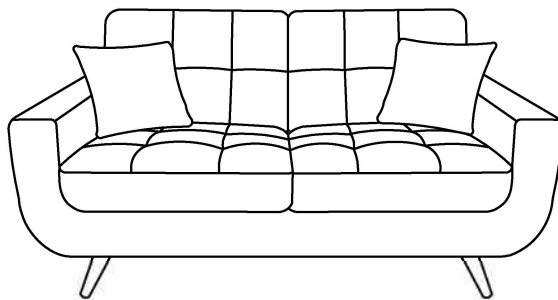

## Care Instruction for Textured Fabric Furniture:

In order to maintain the original appearance of your textured fabric, please follow below simple care procedures:

- Avoid exposing furniture directly to sunlight or heating and air conditioning outlets. Sunlight and or exposure to heating and air conditioning outlets will fade/damage textured fabric.
- Vacuum or wipe with a soft cloth to remove dust.



For items use on wooden floor, hard surfaces or carpets, it is recommended to Install protective pads under all legs and supports to avoid/prevent from damages/scratches and discoloration.