



# Assembly Instruction

## CHAIR

ITEM NO.:8225-1

NOTE:Do not use power tools for assembly.Power tools increase the risk of over tightening which leads to splitting or cracking the wood.

### COMPONENT LIST

NO.	DESCRIPTION	SKETCH	QTY
A	CHAIR SEAT		1 PC
B	BACK REST		1 PC
C	SEAT CUSHION		1 PC

NO.	DESCRIPTION	SKETCH	QTY
D	BACK CUSHION		1 PC
E	LEG		4 PCS
F	GASKET		4 PCS

### STEP1

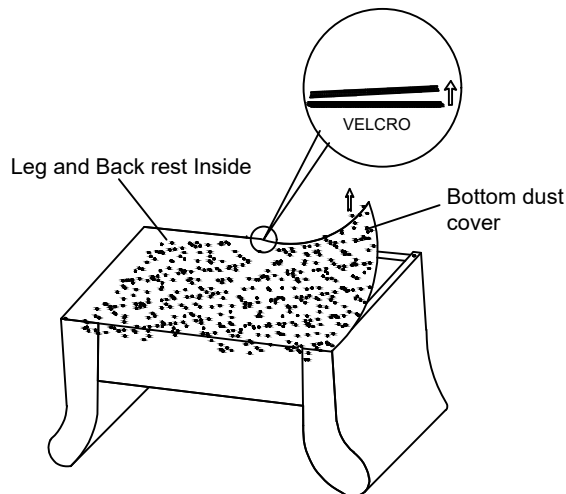

Remove the dust cover,take out the leg and back rest stored at the bottom of the seat for assembly.

### STEP2

Please align male metal bracket on the back onto the female metal bracket on the seat, follow the slope angle to slide in and push to the end. Make sure it is locked in position properly.

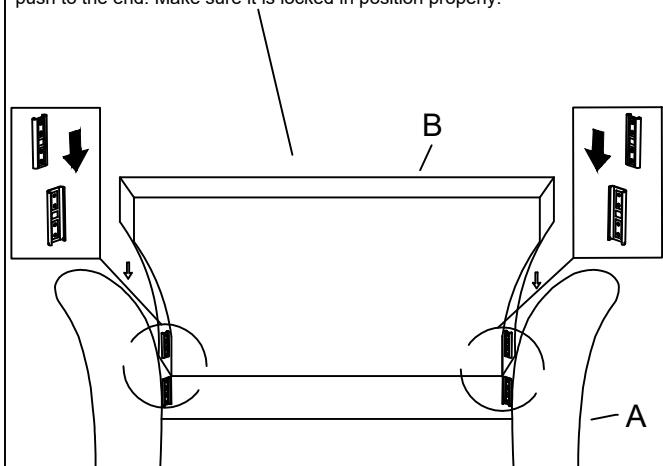

### STEP3

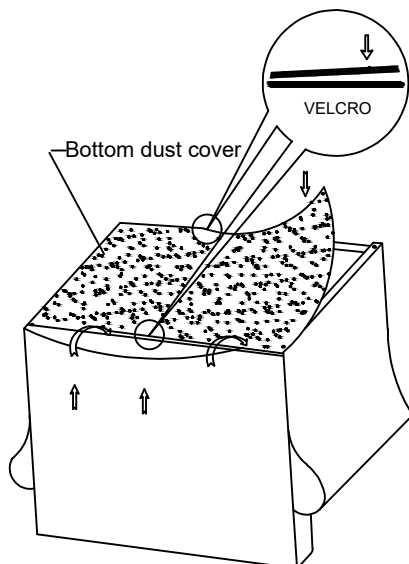

### STEP 4

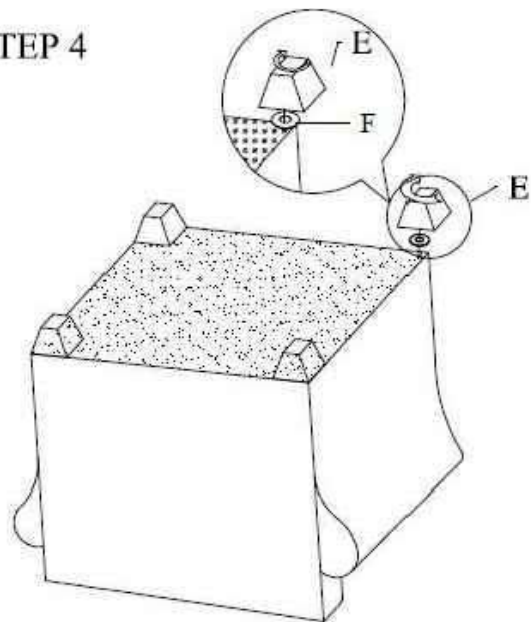

STEP 5

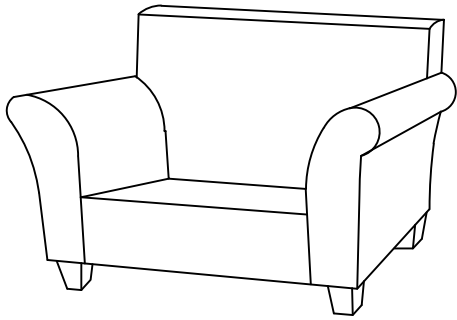

STEP 6

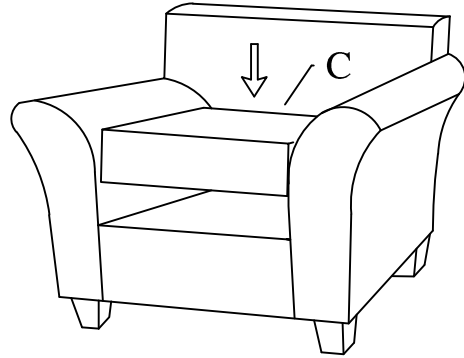

STEP 7

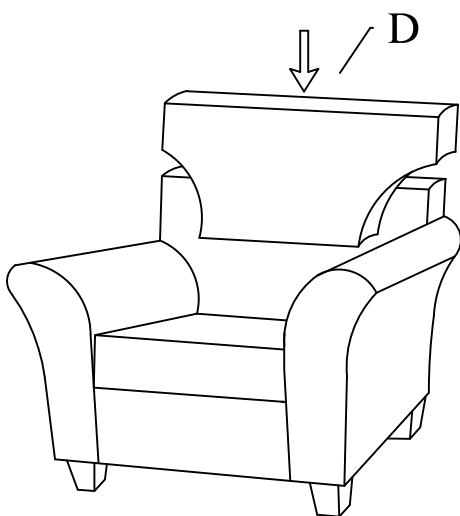

STEP 8

COMPLETED !

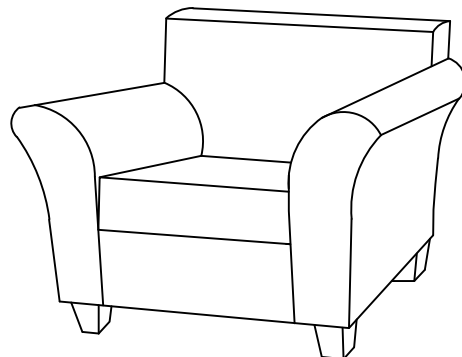

## **CARE INSTRUCTION FOR FABRIC:**

**In order to maintain the original appearance of your fabric furniture, please follow below simple care procedure:**

- **Avoid exposing furniture directly to sunlight or heating and air conditioning outlets. Exposure to sunlight or heating and air conditioning outlets will fade/damage fabric.**
- **Wipe gently with a damp soft cloth to remove dust, dirt and any grime build up.**



**It is recommended to install protective pads under all legs and supports to avoid damage or scratches when placing furniture on a wood floor or other hard surface, and to limit indentation and prevent discoloration if placing on carpet.**



**Il est recommandé de placer des coussins protecteurs sous tous les pieds et toutes les bases des meubles pour éviter d'endommager ou d'égratigner les planchers en bois ou autres surfaces dures, et pour limiter l'empreinte et empêcher la décoloration quand les meubles reposent sur la moquette.**