

Assembly Instruction





ITEM NO.:9337CR-3PW
SOFA

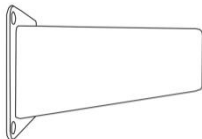
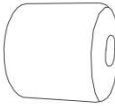

Legs & hardware are stored at the bottom of the seat, please take out for assembly.

Note: Do not use power tools for assembly. Power tools increase the risk of over tightening which lead to splitting or cracking the wood.

Component list

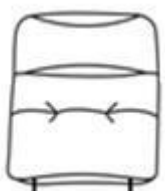
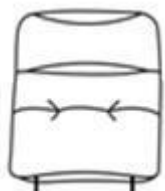
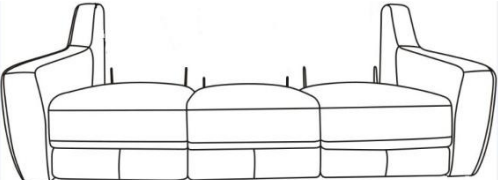
Label	Picture	QTY	Description
A		4PCS	Wooden Leg 3 1/2"x3 1/2"x5 1/2"
B		8PCS	Plastic Leg 2 1/4 "x2 1/4"
C		16PCS	Metal Washer ϕ 1/2"
D		16PCS	Bolt ϕ1/4"X3/4"
E		1PC	Allen Key 2 1/4"X1"
F		8PCS	Screw ϕ1/5"x2"
G		2PCS	Back Rest
G1		1PC	Middle Back Rest
H		1PC	Seat

Step 1

Adaptor seat is pre-connected and located under the seat, please take out the plug and wire for use.

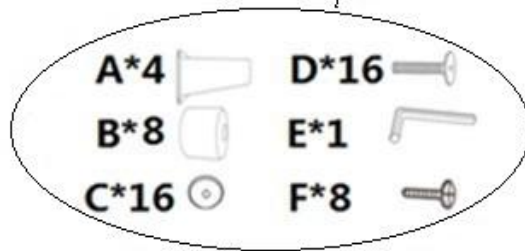
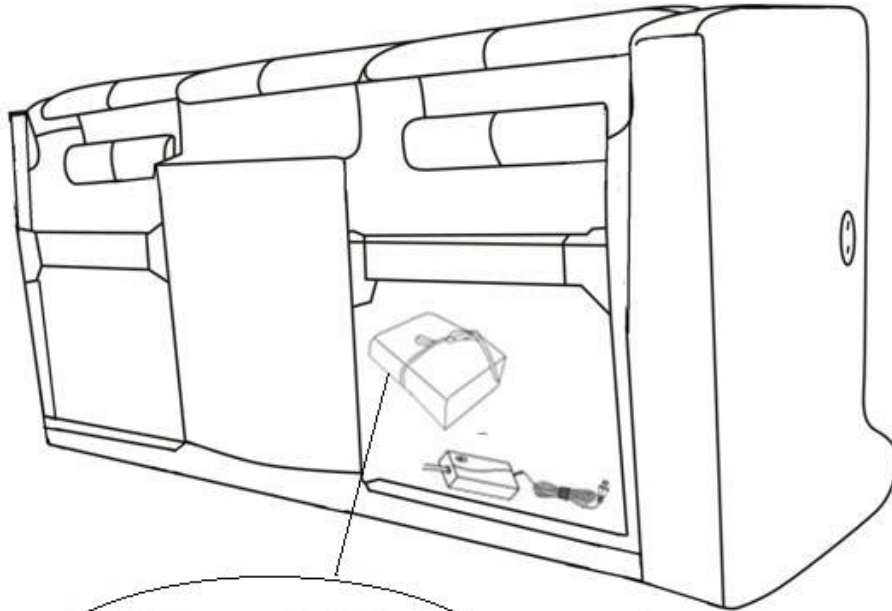

Step 2

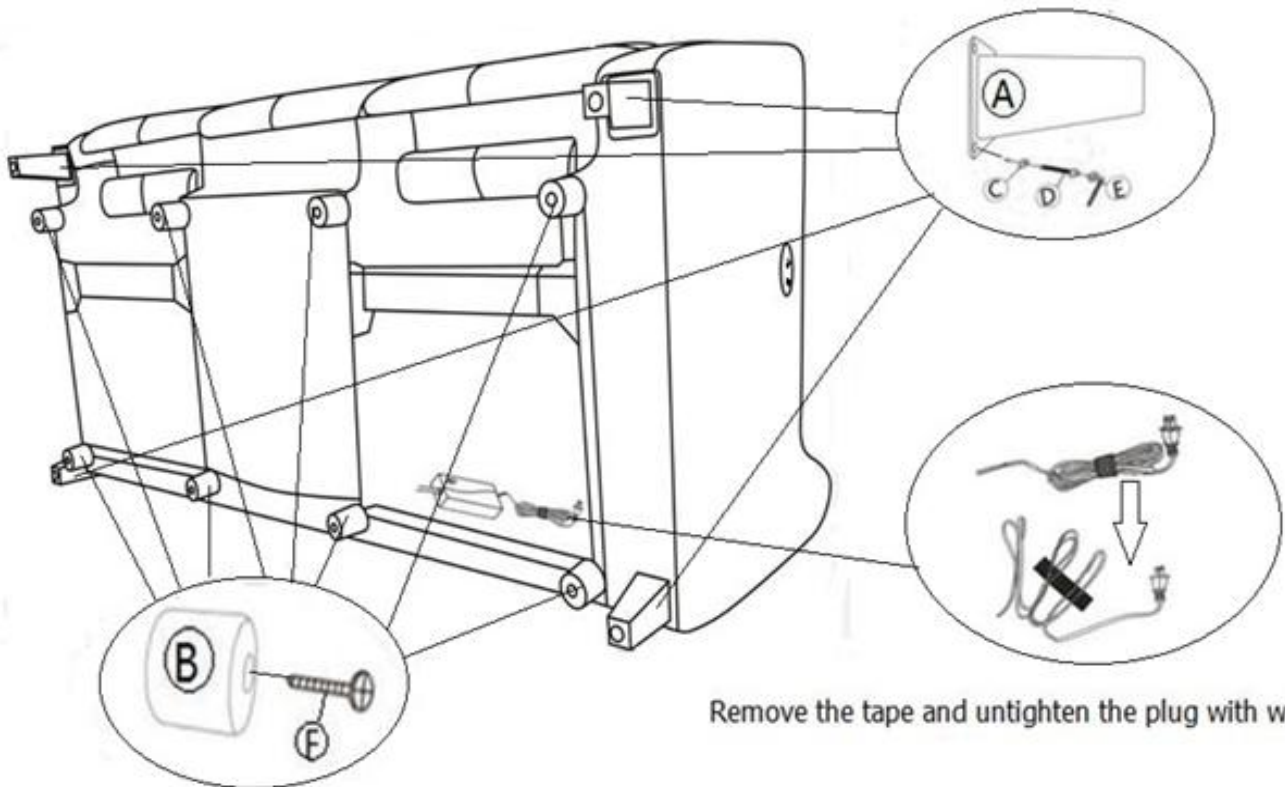

Remove the tape and untighten the plug with wire for use.

Step 3

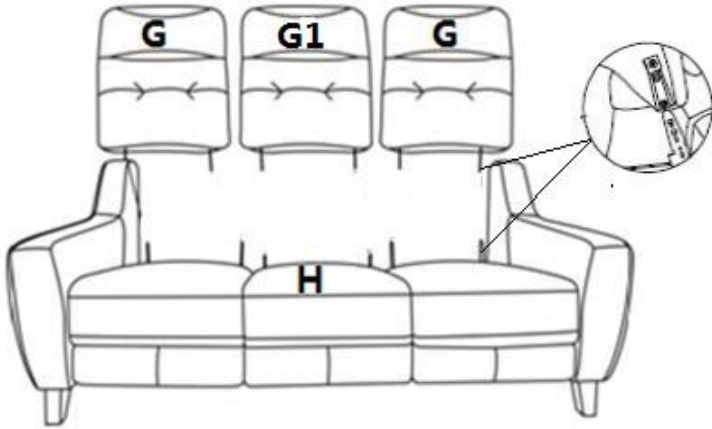

Step 4



Step 5

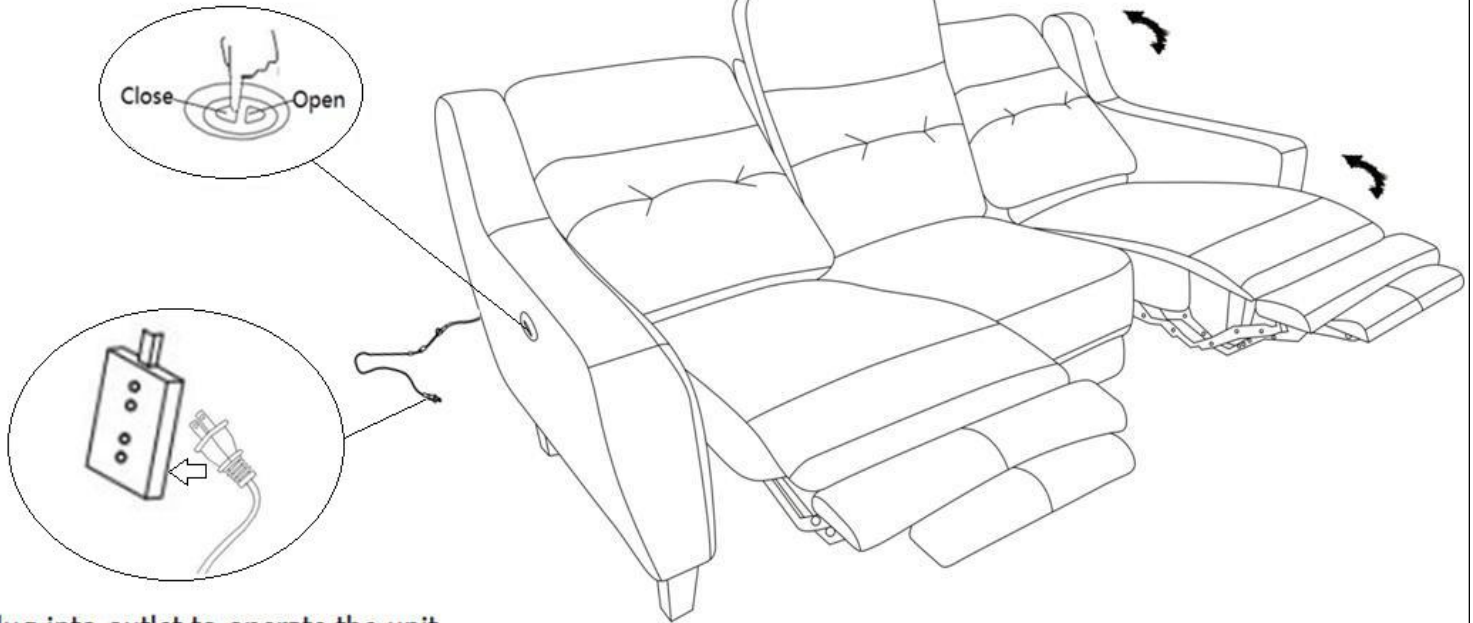

Plug into outlet to operate the unit.

Care Instruction for Top Grain Leather Furniture:

In order to maintain the original appearance of your Top Grain Leather furniture, please follow below simple care procedures:

- Avoid exposing furniture directly to sunlight or heating and air conditioning outlets. Sunlight and or exposure to heating and air conditioning outlets will fade/damage top grain leather.
- Vacuum or wipe with a soft cloth to remove dust.



For item use on wooden floor, hard surfaces or carpets, it is recommended to install protective pads under all legs and supports to avoid/prevent from damages/scratches and discoloration.