







Assembly Instruction

ITEM NO.9334GY-3 SOFA

 Legs and hardware are stored at the bottom of the seat. Please take out the legs and hardware for assembly.

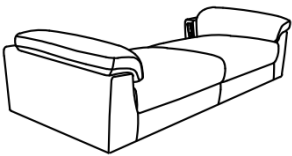
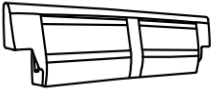
NOTE: Do not use power tools for assembly. Power tools increase the risk of over tightening which lead to splitting or cracking the wood.

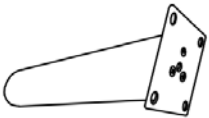
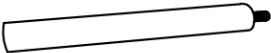
COMPONENT LIST

NO.	DRAWING	QTY	DESCRIPTION
A		1PC	SEAT
B		1PC	BACK REST
C		1PC	LSF BACK CUSHION
D		1PC	RSF BACK CUSHION
E		4PCS	WOODEN LEG
F		1PC	MIDDLE METAL SUPPORT LEG
G		16PCS	Bolt (M6x25MM)

STEP#1 Take out the legs and back from the bottom of the seat for assembly

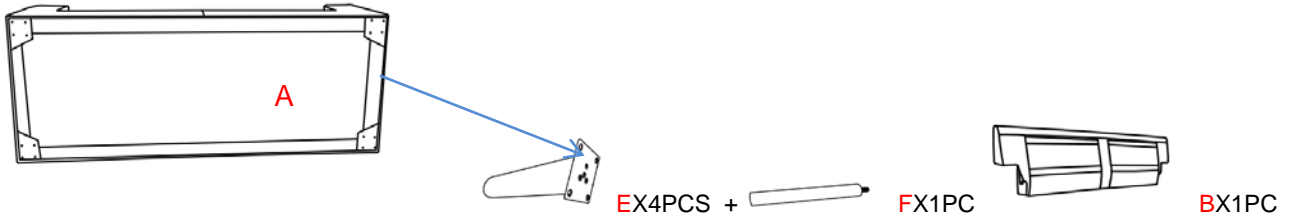

STEP#2

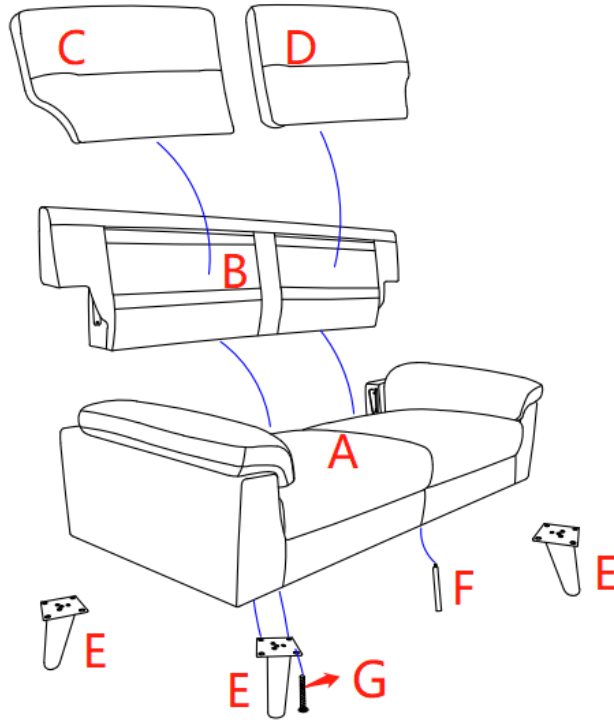

STEP #3: Sofa Assembly is completed.

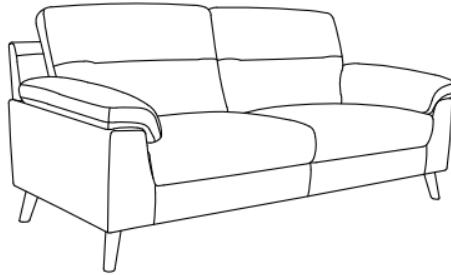

Care instruction for PU furniture.

In order to maintain the original appearance of your PU furniture, please follow below simple care procedures:

- Avoid exposing furniture directly to sunlight or heating and air conditioning outlets. Sunlight and/or exposure to heating and air conditioning outlets will fade/damage PU fabrics
- Vacuum or wipe with a cloth regularly to remove dust.



For items use on wooden floor, hard surfaces or carpets, it is recommended to Install protective pads under all legs and supports to avoid/prevent from damages/scratches and discoloration.