



1160003

Cyprus Fabric Chair

Assembly Instructions

Hardware identification



Ⓐ M6*20MM x 12

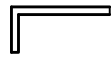

Ⓑ M5 x 01

Part identification

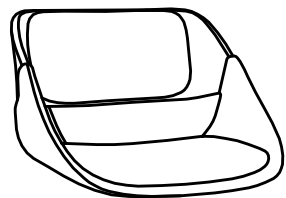

① x 1PC

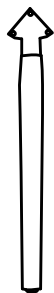

② x 2 PCS

Front leg

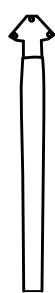
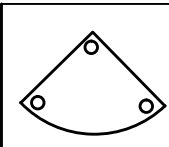

③ x 2 PCS

Rear leg

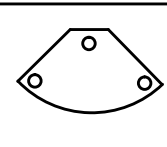

1

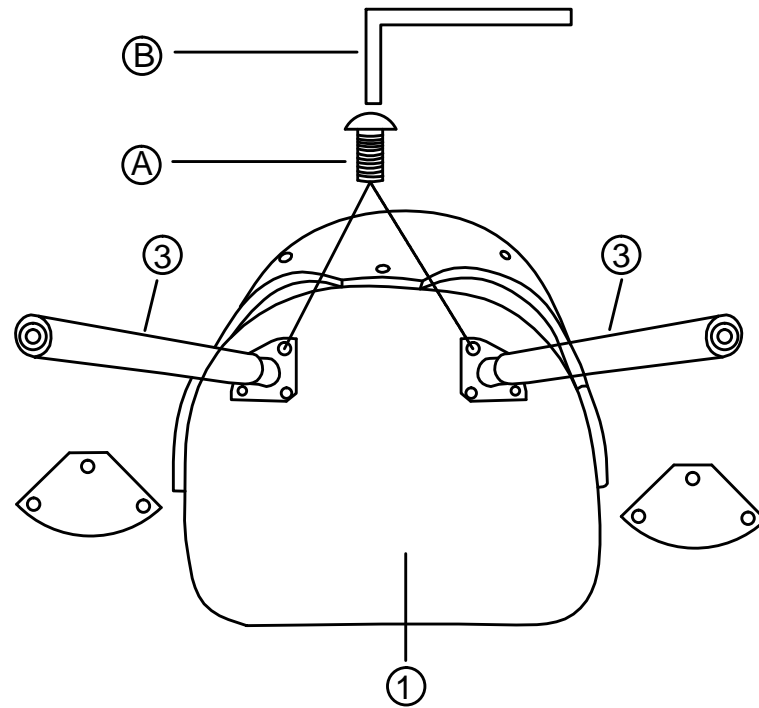

2

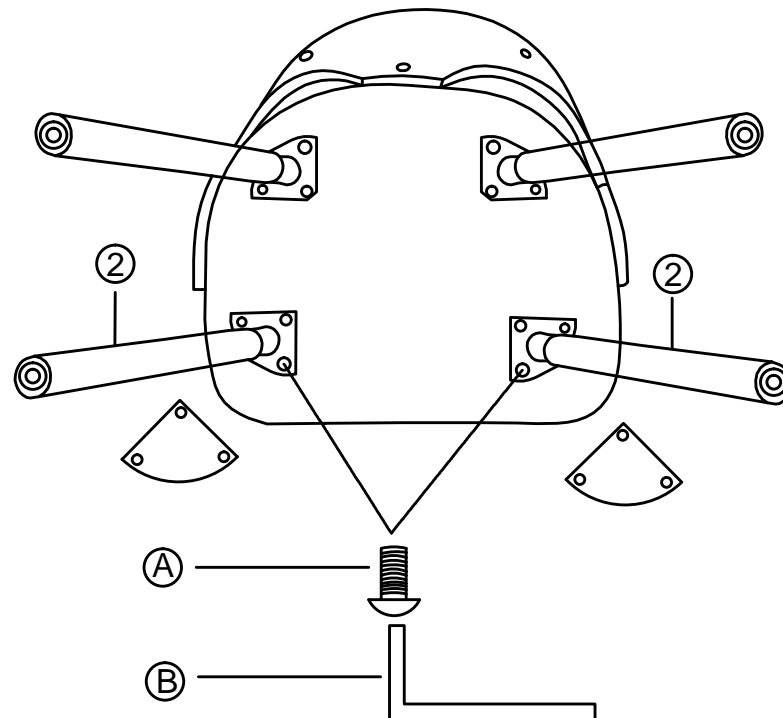

3

