

Assembling scheme

Required tools:

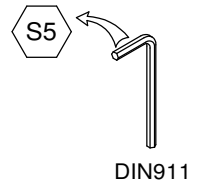

Hardware:

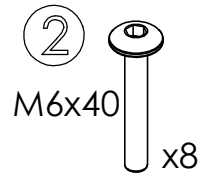
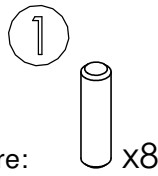

Product:

a)

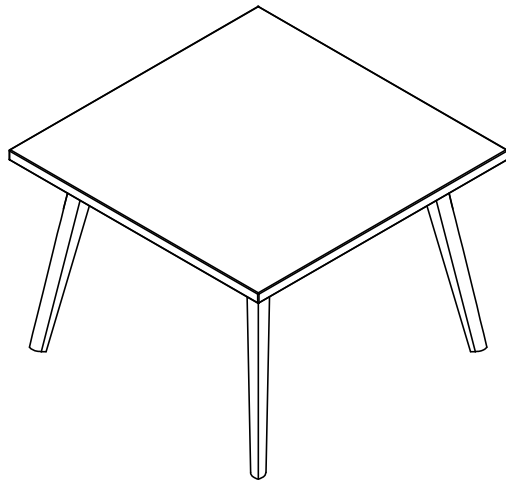

b)

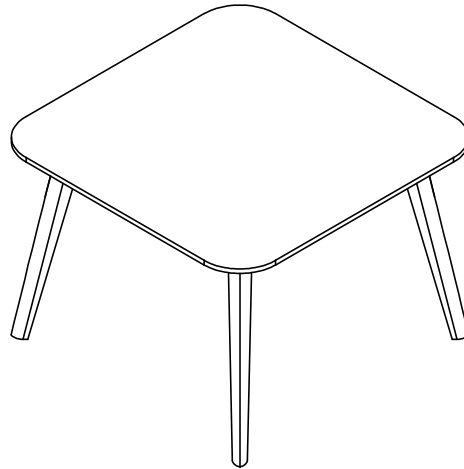

c)

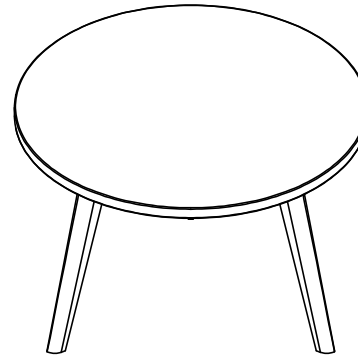

d)



Parts:

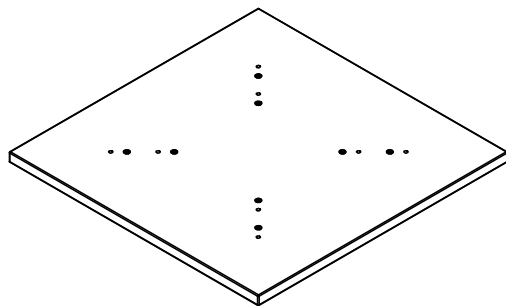

a)

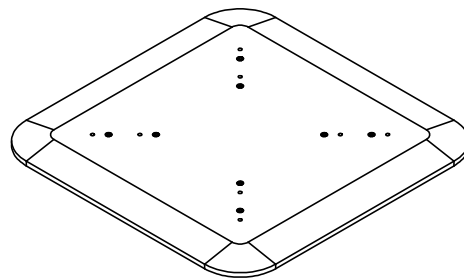

b)

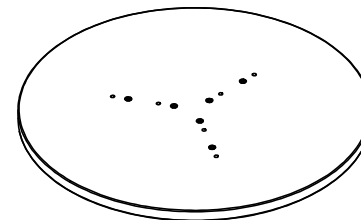

c)

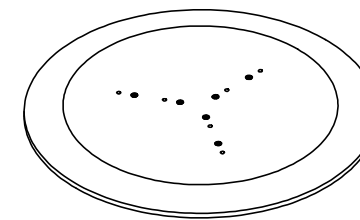

d)

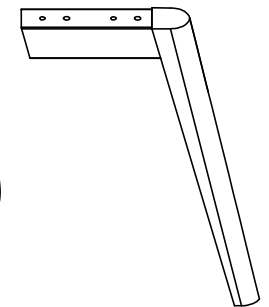

a) & b) x4
c) & d) x3

1

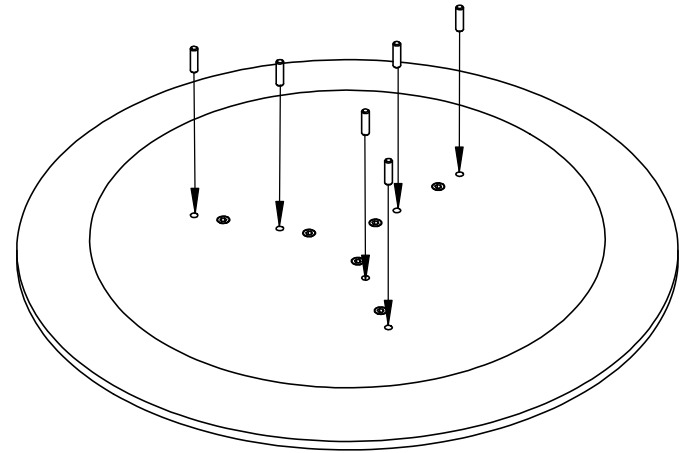
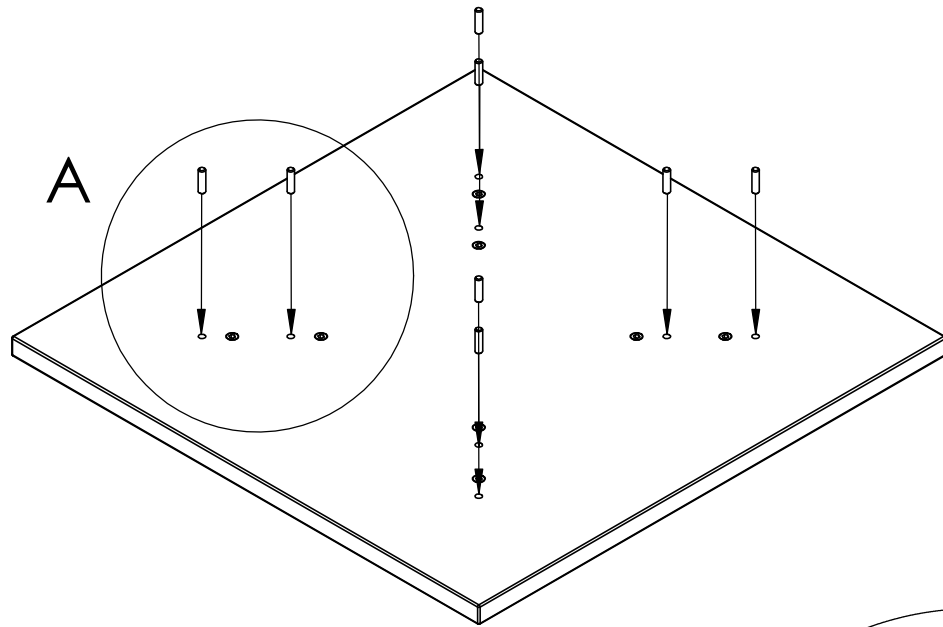

A

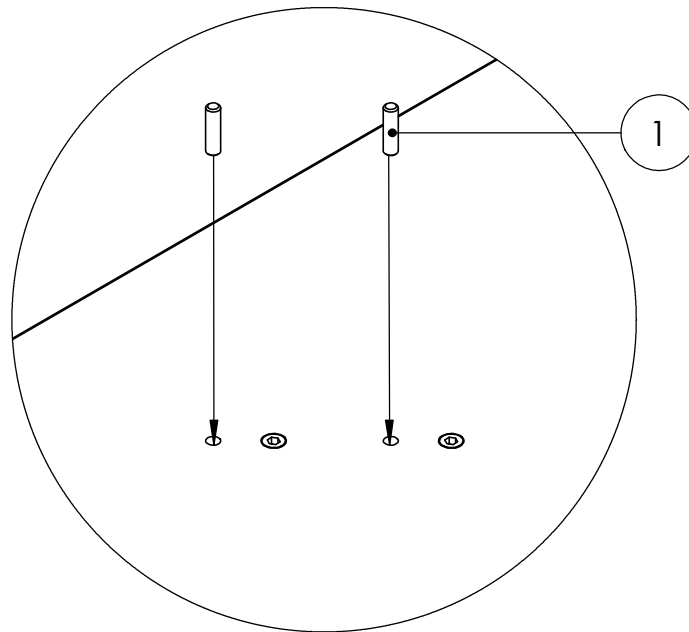

2

