



# ASSEMBLY INSTRUCTIONS

## ISO SINGLE CHAIRBED



**GENERAL NOTE: CAREFULLY REMOVE ALL WRAPPING MATERIALS AND ENSURE ALL PARTS ARE ACCOUNTED FOR. ASSEMBLE ON A CLEAN FLAT SURFACE TO AVOID SCRATCHES. DO NOT DISCARD THE PACKAGING UNTIL ITEM IS FULLY ASSEMBLED.**

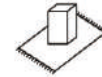

**GENERAL NOTE: CAREFULLY REMOVE ALL WRAPPING MATERIALS AND ENSURE ALL PARTS ARE ACCOUNTED FOR. ASSEMBLE ON A CLEAN FLAT SURFACE TO AVOID SCRATCHES. DO NOT DISCARD THE PACKAGING UNTIL ITEM IS FULLY ASSEMBLED.**



- a=4 M6X45mm
- b=4 Ø6
- c=4 Ø6
- d=1 4mm
- e=1 M8X35mm
- f=2 Ø8
- g=1 m8
- h=1 6mm
- i=1 13mm

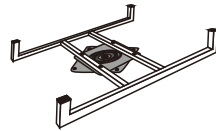

A=1

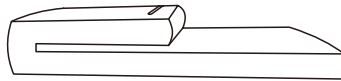

B=1

1

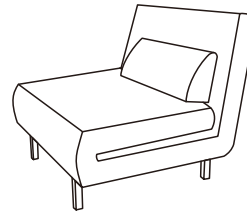

2

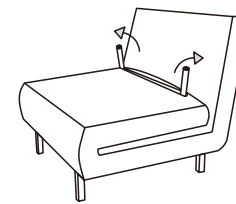

3

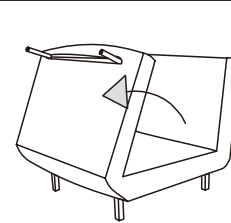

4

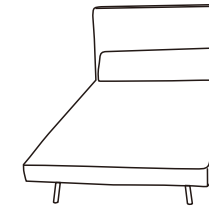

5

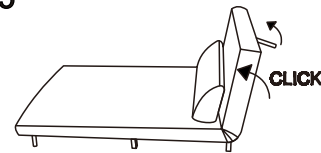

6

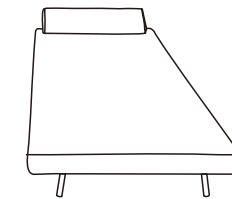

step1

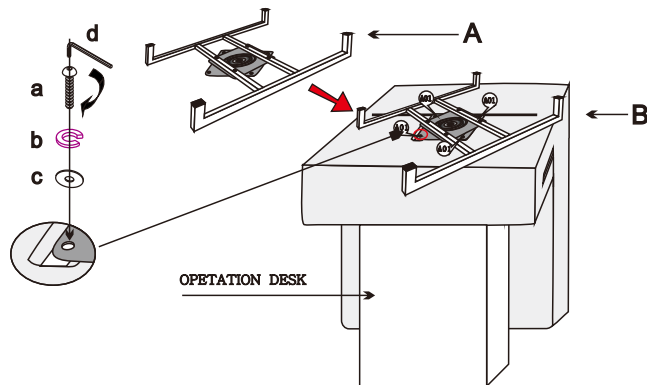

step2

