

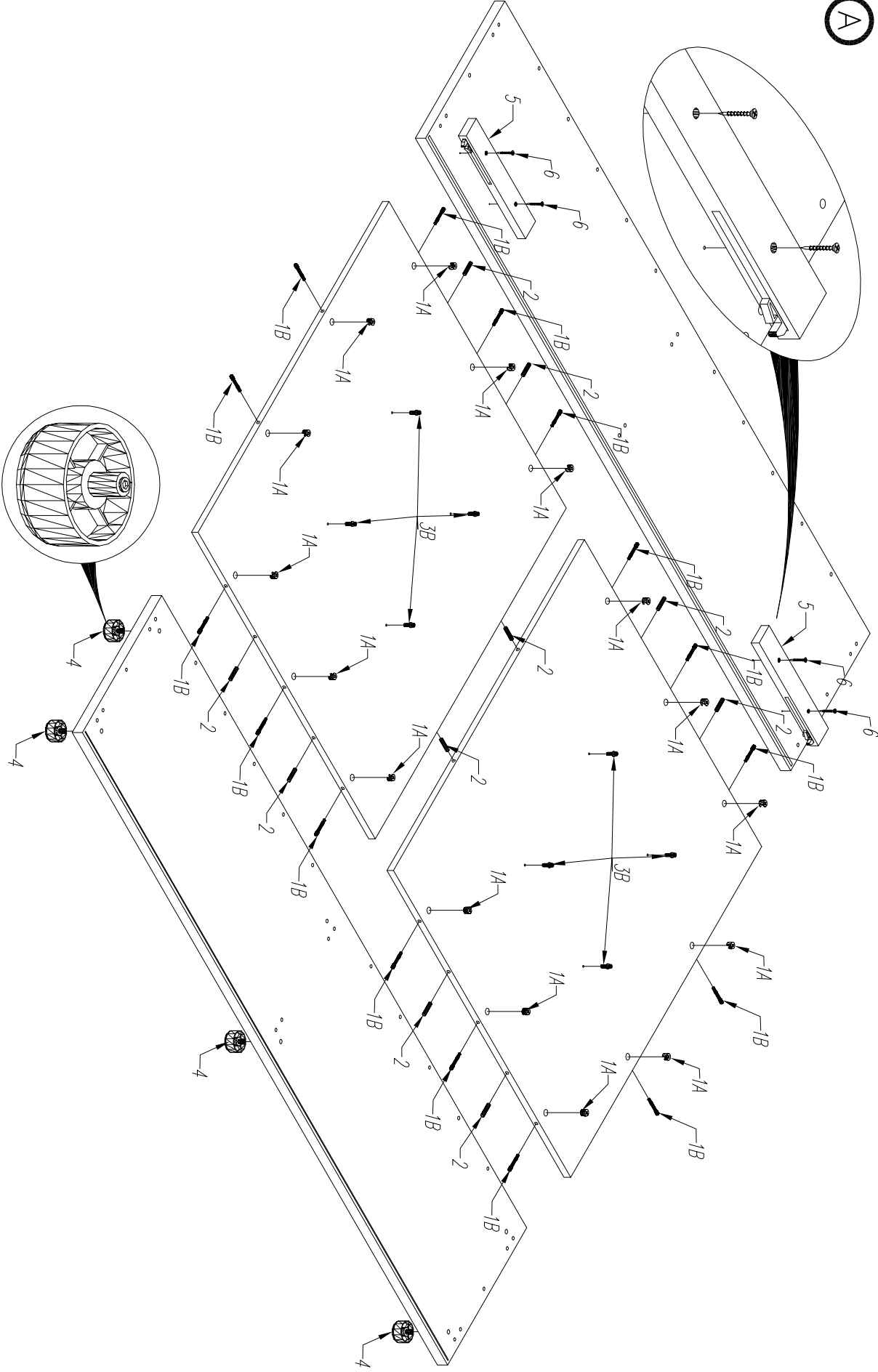

1		x28
2		x24
3		x24
4		x6
5		x2
6		x4
7		x4

(A)





ZS

□□□□

KOLEJNOŚĆ MONTAŻU  
MIMOSPODÓW I KOLKÓW.  
THE FITTINGS SEQUENCE OF THE  
GAMS AND DOWELS.  
DIE MONTAGEFOLGE VON  
EXZERNEN UND DREHIN.

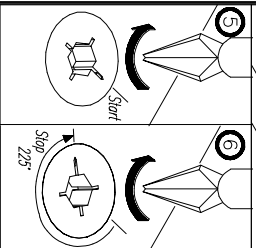
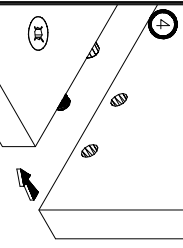
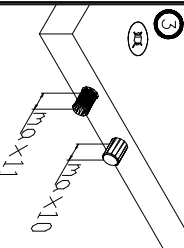
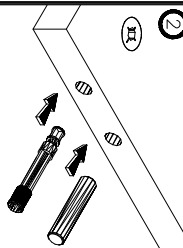
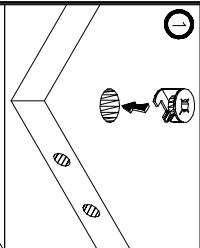

1		x28
2		x24
3		x24
4		x6
5		x2
7		x4
8		x4

(A)

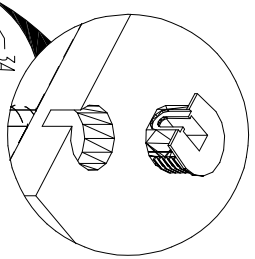
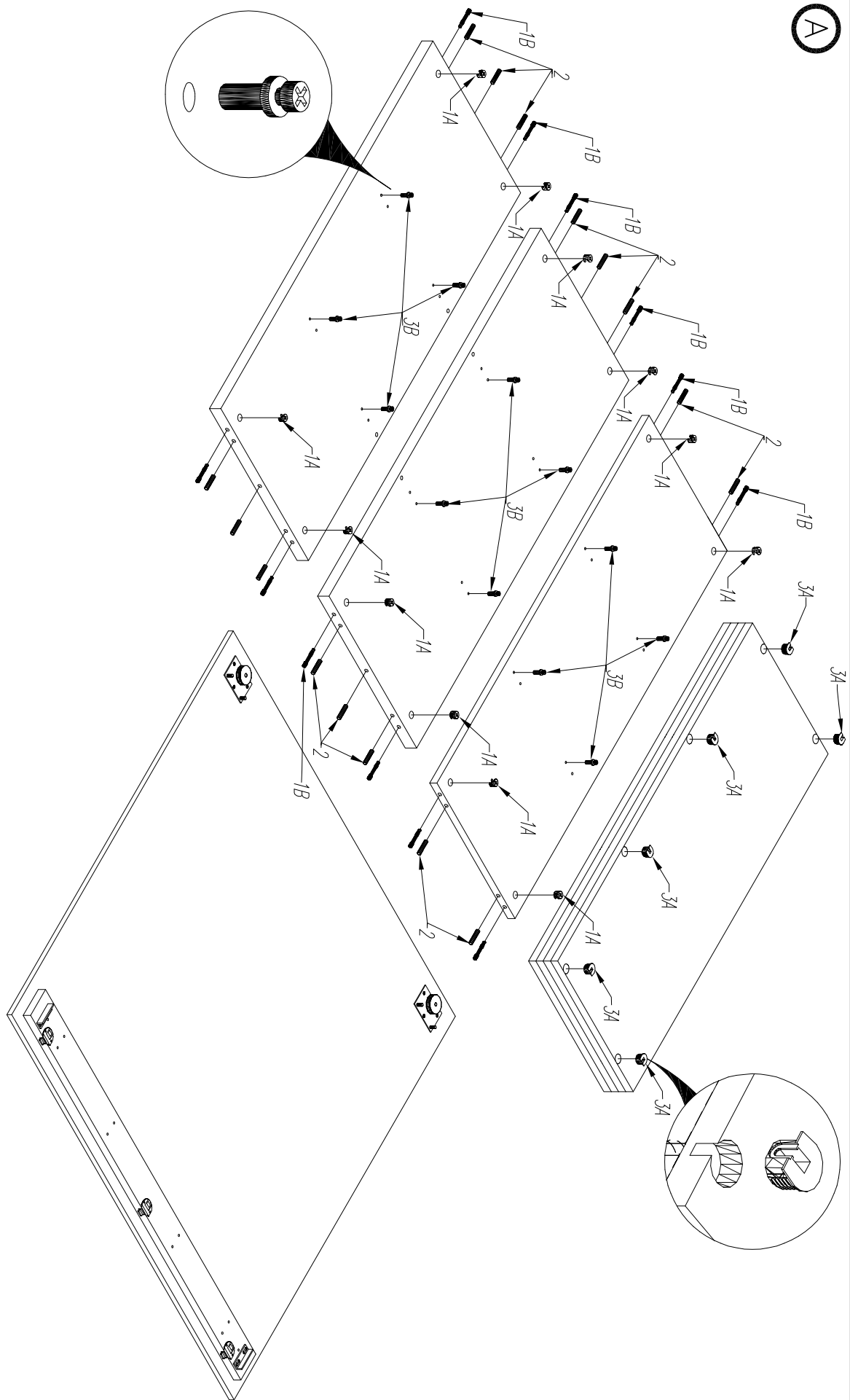

ZS

KOLEJNOŚĆ MONTAŻU  
MONTAZOVÝ SEQUENC  
THE FITTINGS SEQUENCE OF THE  
GAINS AND DOMELS.  
DIE MONTAGEFOLGE VON  
EXZERNERN UND DREHLEN.

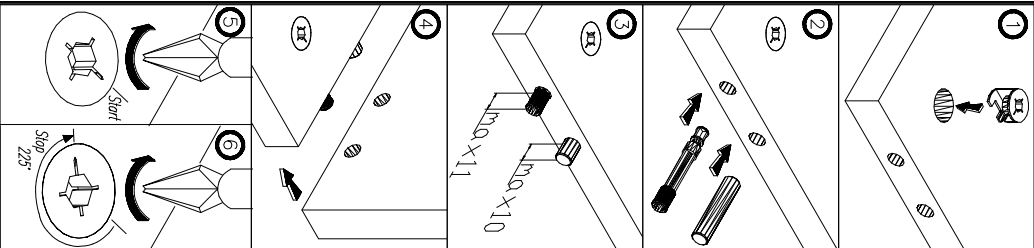

B

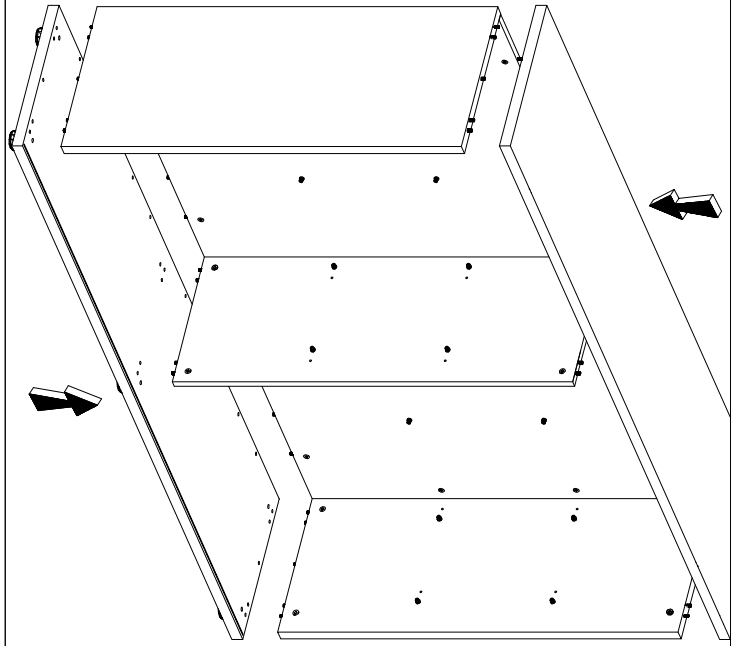

D

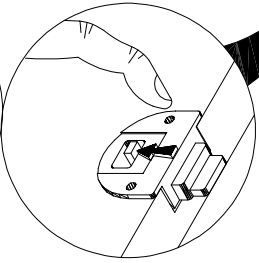
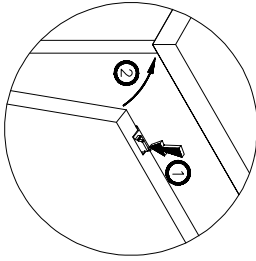
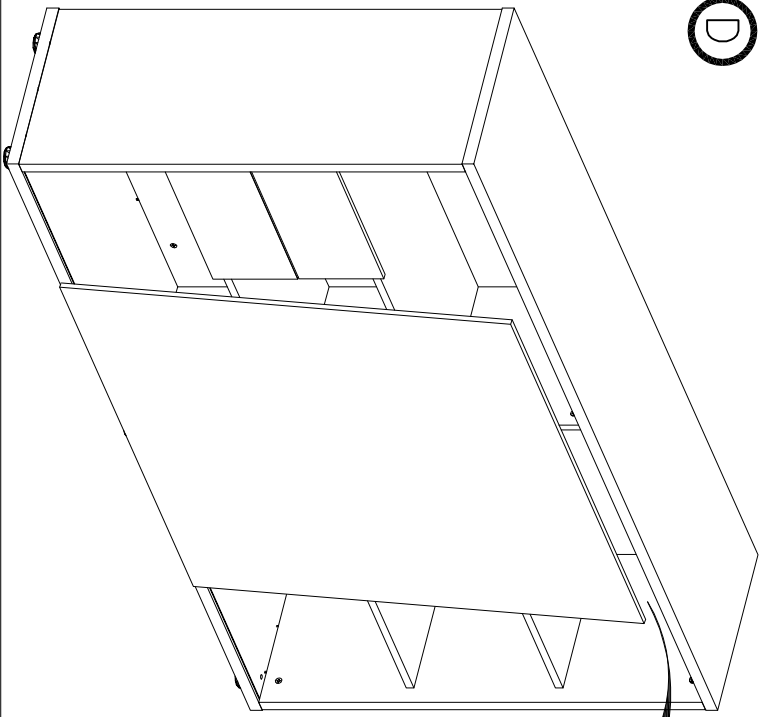

C

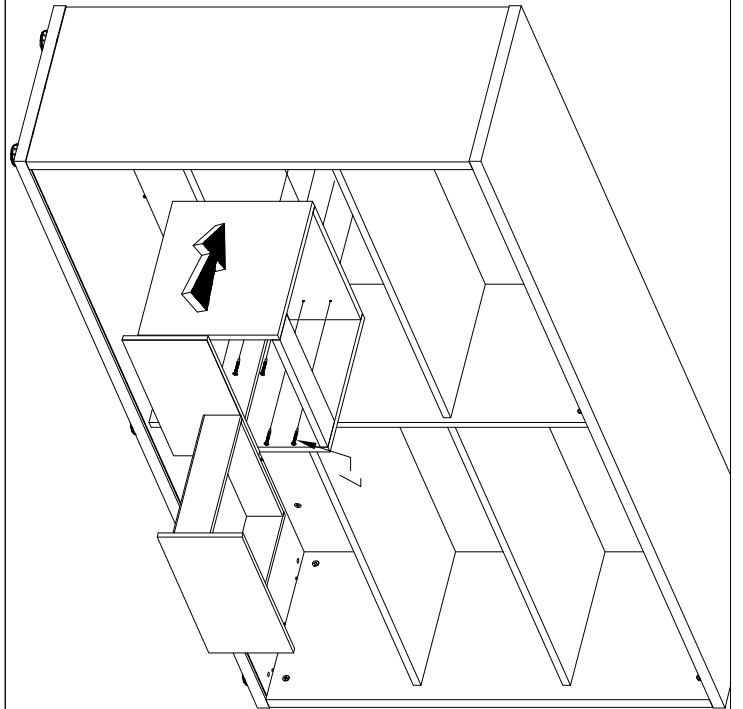

E

