

# Sonic - freestanding screens technical specification



.mdd

**MDD has a leading position among manufacturers of office furniture with many awards that prove quality and continuously increase demand for its products.**

The realities of today's market require constant quality improvement at all levels of modern organization. This applies in particular to customer service, marketing, quality of products and also to quality of processes within the company. Partnership relations among employees and with business partners form a base of economic growth and success of the company.

Constant investments in innovative machinery park, optimization of management systems and an expansion of production halls allow to minimize the lead times for the product of the highest quality.

**More than twenty years of experience in office furniture industry come with reference from a long list of companies and institutions to show their appreciation for an efficient and comprehensive service.**

**MDD is highly aware of the environment.**

Being located in the forest region with lake by its side, MDD takes the nature seriously and invests constantly in a modern and energy-efficient solutions to preserve the local life. Company puts emphasis on waste segregation and recycling. MDD has been awarded for the exceptional care and involvement in waste disposal. All materials used are environmentally friendly and enjoy a high 95 % rate of being recycled.



**General informations:**

**Warranty:**

MDD products - **5 years.**

Electrical components and fabric - **2 years.**

**Certificate - MFC:**



**Certificate - fabric:**



**Assembly:**

product delivered in separate elements

**Packing:**

cardboard, packing film

**Compliant with standards:**

PN-EN ISO 354:2005

**Boards density:**

12 mm - 690 - 750 kg/m<sup>3</sup>

18 mm - 650 - 690 kg/m<sup>3</sup>

28 mm - 610 - 630 kg/m<sup>3</sup>

36 mm - 610 - 630 kg/m<sup>3</sup>

**Sonic - freestanding screens**

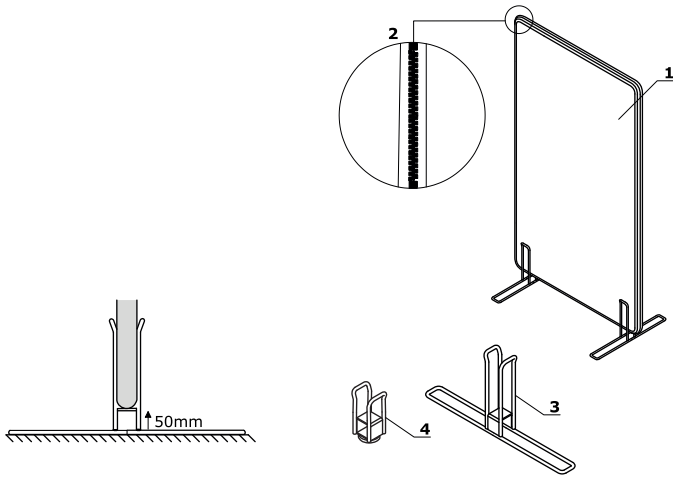

- 1. Fabric - accoustic class A, pinable
- 2. Zip fastener
- 3. Freestanding feet - powder coated metal
- 4. Spacer - powder coated metal; intended for use in screens situated between desks or other solid support from both sides

ATTENTION - Free standing panel in height W1 - 50 mm from the bottom

**Sonic - connecting element for free standing screens**

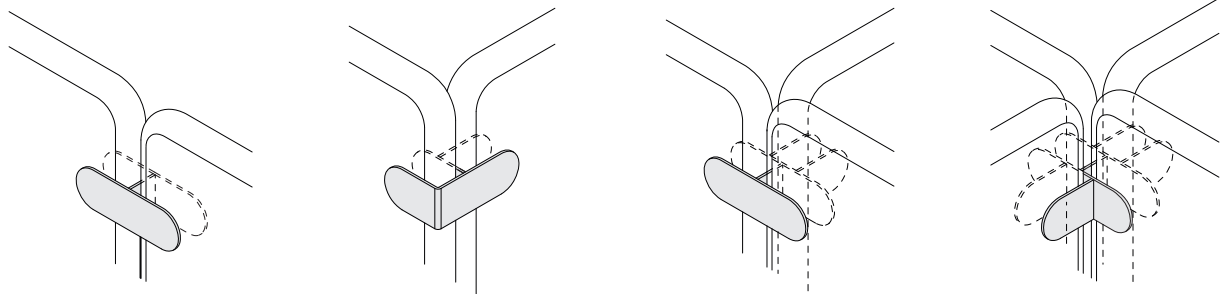

**ZW5**

**ZW6**

**ZW7**

**ZW8**

Sonic - freestanding screens \*

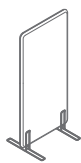

**ZW592**  
590 / 40 / 1250  
17.2 kg



**ZW594**  
590 / 40 / 1450  
18.2 kg



**ZW596**  
590 / 40 / 1650  
19.2 kg



**ZW598**  
590 / 40 / 1850  
20.2 kg

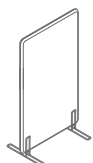

**ZW692**  
690 / 40 / 1250  
17.7 kg

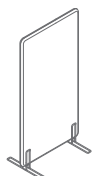

**ZW694**  
690 / 40 / 1450  
18.7 kg

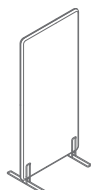

**ZW696**  
690 / 40 / 1650  
19.7 kg



**ZW698**  
690 / 40 / 1850  
20.7 kg

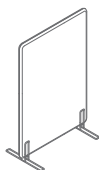

**ZW792**  
790 / 40 / 1250  
18.2 kg

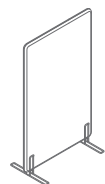

**ZW794**  
790 / 40 / 1450  
19.2 kg

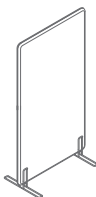

**ZW796**  
790 / 40 / 1650  
20.2 kg

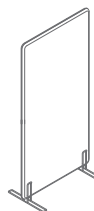

**ZW798**  
790 / 40 / 1850  
21.2 kg

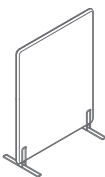

**ZW892**  
890 / 40 / 1250  
18.7 kg

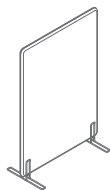

**ZW894**  
890 / 40 / 1450  
19.7 kg

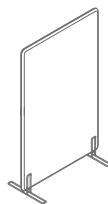

**ZW896**  
890 / 40 / 1650  
20.7 kg

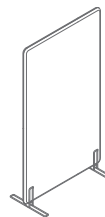

**ZW898**  
890 / 40 / 1850  
21.7 kg

\* dimensions expressed in millimeters: width x depth x height

**Sonic - freestanding screens \***

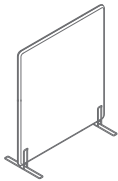

**ZW992**  
990 / 40 / 1250  
19.2 kg



**ZW994**  
990 / 40 / 1450  
20.2 kg



**ZW996**  
990 / 40 / 1650  
21.2 kg

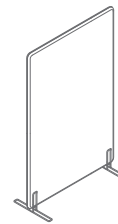

**ZW998**  
990 / 40 / 1850  
22.2 kg

**Sonic - connecting element for free standing screens \***



**ZW5**  
150 / 37 / 50  
0.4 kg



**ZW6**  
150 / 116 / 50  
0.4 kg



**ZW7**  
150 / 116 / 50  
0.5 kg



**ZW8**  
150 / 190 / 50  
0.7 kg

\* dimensions expressed in millimeters: width x depth x height

### Fabric Nemo

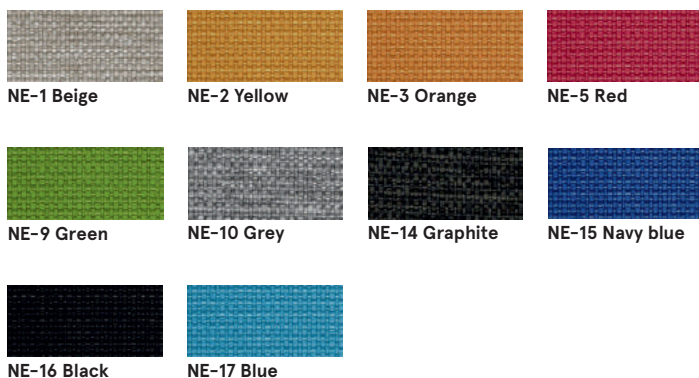

**Technical data:**

**Material** polyester 100%

**Fabric weight** 366g/m2

**Abrasion resistance rubs** PN\_EN ISO 12947 - 2:2 100,000

**Pilling resistance** scale 1-8, max. 8, PN-EN ISO 105 - B02 (3-4)

**Colour fastness to light** scale 1-5, max. 5, PN-EN 1021 - 2,

**Colour fastness to rubbing** PN-EN 1021 - 1  
skcale 1-5, max. 5, EN ISO 105x12 (wet/dry) 4-5

### Fabric Runner - second price group

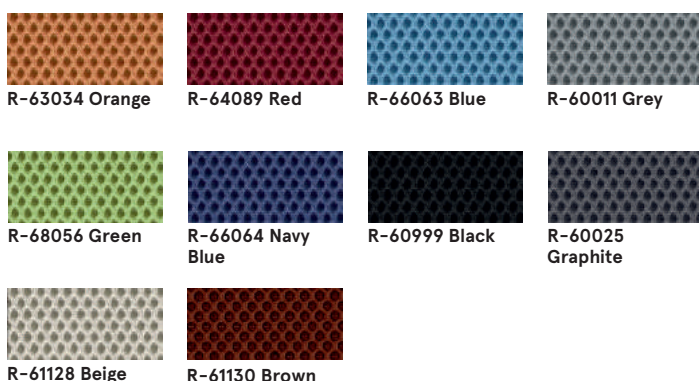

**Technical data:**

**Material** 80% polyester, 20% post-consumer recycled polyester

**Fabric weight** 510 g/lm (16.45 oz/lin.yd.)

**Abrasion resistance rubs** BS EN ISO 12947-2  
70,000 Martindale cycles

**Pilling resistance** scale 1-5, max 5, EN ISO 12945-2 (4-5)

**Colour fastness to light** scale 1-8, max 8, EN ISO 105-B02 (5-7)

**Colour fastness to rubbing** scale 1-5, max 5, EN ISO 105x12 (wet/dry) 4-5

**Acoustic test sound absorption** ISO 354

**Flammability** BS EN 1021-2 Match,  
CA TB 117-2013, BS EN 1021-1 (cigarette) Class Uno UNI 9175 Class 2, EMME

### Fabric Medley - second group



**Technical data:**

**Material** polyester 100%

**Fabric weight** 510 g/lm (16.45 oz/lin.yd.)

**Abrasion resistance rubs** BS EN ISO 12947-2, 75,000 cykli Martindale

**Pilling resistance** scale 1-5, max. 5, EN ISO 12945-2 (4)

**Colour fastness to light** scale 1-8, max. 8, EN ISO 105-B02 (5-7)

**Colour fastness to rubbing** scale 1-5, max. 5, EN ISO 105x12 (wet/dry (4-5/4-5))

**Acoustic test sound absorption** ISO 354

**Flammability** BS EN 1021-1 (cigarette)  
BS 476 Part 7, Class 2  
Class Uno UNI 9174 - UNI 8457  
CA TB 117-2013  
ASTM E 84 Class I

### Fabric Atlantic \* - second price group



**Technical data:**

**Material** polyester 100%

**Fabric weight** 530 g/lm (17.09 oz/lin.yd.)

**Abrasion resistance rubs** BS EN ISO 12947-2, 110,000 Martindale cycles

**Pilling resistance** scale 1-5, max. 5, EN ISO 12945-2 (4-5)

**Colour fastness to light** scale 1-8, max. 8, EN ISO 105-B02 (5-7)

**Colour fastness to rubbing** scale 1-5, max. 5, EN ISO 105x12 (wet/dry)

**Flammability** CA TB 117-2013  
ASTM E 84 Class I  
BS EN 1021-2 (match)  
BS EN 1021-1 (cigarette)

### Fabric River - second group



**Technical data:**

**Material** polyester 100%

**Fabric weight** 300g/m2 (+/- 5%)

**Abrasion resistance rubs** 100,000 Martindale cycles (EN ISO 12947-1,2)

**Pilling resistance** EN ISO 12945-2 (5)

**Colour fastness to light** 4 (EN ISO 105-B02)

**Colour fastness to rubbing** dry: 4-5, wet: 3 (EN ISO 105-x12)

**Flammability** BS 5852: Part 1, Ignition Source 0 (cigarette)  
BS 5852: Part 1, Ignition Source 1 (match)  
En1021 - 2

### Fabric Vita - second price group



**Technical data:**

**Material** Surface: 98,5% PVC, 1,5% PU  
Substrate: 50% poliester, 50% Cotton

**Fabric weight** 850g/m2 ± 10% (1190G/lin. m ± 10%)

**Abrasion resistance rubs** BS EN ISO 5470-2, 100,000 Martindale cycles

**Colour fastness to light** 6 (ISO 105 - B02)

**Colour fastness to rubbing** wet: 4, dry: 4 (ISO 105 - X12)

**Flammability** BS EN 1021 - (cigarette)  
BS EN 1021 - 2 (match)  
BS 5852 - (Ignition Source 5)  
BS 7176 - (Medium Hazard)

**Flexes** BS EN ISO 7854 - Method B, 400.000 Flexing cycles

**Anti-microblal / Anti-fungal** AATCC 147

\* There is a possibility of ordering the product in full colour spectrum of Atlantic range, as per Gabriel's pattern book, within 8 weeks

### Fabric Xtreme - third price group



**Technical data:**

**Material** 100% Trevira Clame (CS)  
100% Recycling (YS)  
Flame Retardant polyester.  
Non metallic dyestuffs.

**Fabric weight** 310 g/m2 ±5% (435g/lin.m ±5%)

**Abrasion resistance rubs** 60,000 Martindale cycles (CS)  
100,000 Martindale cycles (YS)

**Colour fastness to light** 6 (ISO 105 - B02)

**Colour fastness to rubbing** wet: 4, dry: 4 (ISO 105 - X12)

**Flammability** EN 1021 - 1 (cigarette),  
EN 1021 - 2 (match)  
BS 7176 Low Hazard,  
NF P92-507 M1, DIN 4102 B1,  
UNI 9175 Class 1 IM, UNI 8456,  
UNI 9174 & UNI 9177 Classe Uno,  
ÖNORM B 3825 & A 3800-1  
NF D 60-013

### Fabric Synergy - third price group

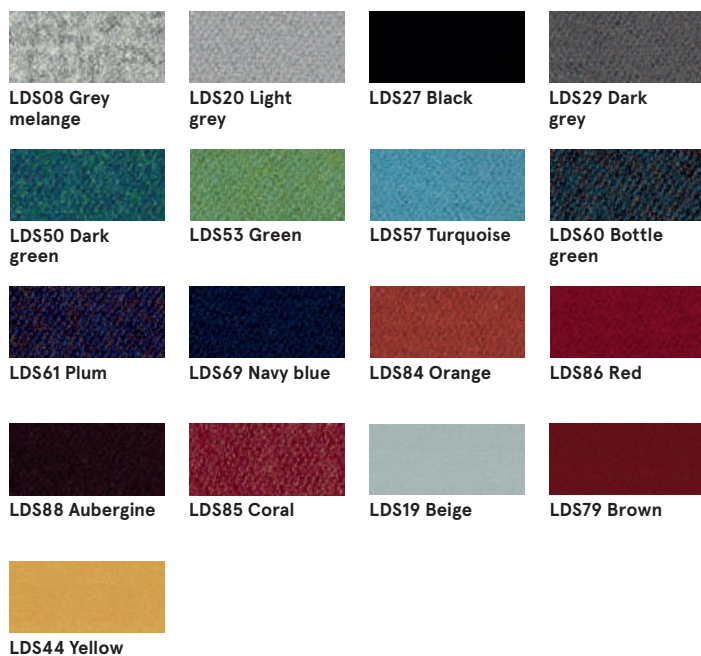

**Technical data:**

**Material** 95% Virgin Wool, 5% Poliamid

**Fabric weight** 400g/m2 ±5% (560 g/lin.m ±5%)

**Abrasion resistance rubs** Independently certified  
≥100,000 Martindale cycles

**Colour fastness to light** 5 (ISO 105 - B02)

**Colour fastness to rubbing** ISO 105 - X12 - wet: 4, dry: 4

**Flammability** EN 1021 - 1 (cigarette),  
EN 1021 - 2 (match),  
BS 7176 Low Hazard,  
UNI 9175 Classe 1 IM,  
ÖNORM B 3825 & A 3800-1



## Fabric Silvertex – third price group

There is a possibility of ordering the product in full colour spectrum of Silvertex range, as per Spradling’s pattern book, within 15 working days.

### Technical data:

<b>Material</b>	Topcoat: 100% Vinyl Backing: 100% Polyesterr Hi-Loft™
<b>Fabric weight</b>	685 gr/m2
<b>Abrasion resistance</b>	>300,000 cycles Martindale
<b>UV-resistance</b>	>= 7 (1000 hours, blue wool scale)
<b>Cold Crack resistance</b>	-23°C
<b>Flame retardancy</b>	NF P 92-503 / M2 EN 1021, Part 1&2 DIN 4102 B2 ÖNORM B 3825, Gruppe I – Schwerbrennbares Verhalten ÖNORM A 3800, Teil I, Qualmbildungsklasse QI – schwachqualmend IMO Res. MSC.307 (88) (2010 FTP Code) Annex I Part 8 (MED) Marine Equipment Directive in its current valid version UNI 9175 (1987) / UNI 9175/FAI (1994) Classe I.IM (uno I EMME) UNE 23.727-90 IR /M2 EN 71-2: 2006+AI: 2007 Safety of Toys – Part 2: Flammability ECE R 118 (replaces Directive 95/28/EC) FMVSS 302 FAR 25/853
<b>Antimicrobial</b>	Antifungal Protection, Antibacterial Protection, Antimycotic Protection

## Fabric Atlas – fourth price group



### Technical data:

<b>Material</b>	90% new wool, 10% nylon
<b>Fabric weight</b>	286g/m2, 400g/lm
<b>Abrasion resistance rubs</b>	100,000 cyklí Martindale, EN ISO 12947
<b>Colour fastness to light</b>	ISO 105 B02: 6-7
<b>Colour fastness to rubbing</b>	ISO 105-X12:2001, (wet/dry) 4-5/4-5
<b>Flammability</b>	BS EN 1021-2 Match, BS EN 1021-1 Cigarette, BS 5 5852 Crib 5, BS 5852 ignition source 3, BS 5852 Part 1, NF D 60 013, UNI 9175 1IM, US Cal. Bull. 117-2013

## Fabric Field2 – fourth price group



### Technical data:

<b>Material</b>	100% Trevira CS
<b>Fabric weight</b>	321g/m2, 450g/lm
<b>Abrasion resistance rubs</b>	100,000 cyklí Martindale, EN ISO 12947
<b>Colour fastness to light</b>	ISO 105 B02: 5-7
<b>Flammability</b>	BS EN 1021-2 Match, BS EN 1021-1 Cigarette, BS 5 5852 Crib 5, DIN 4102 B1 FAR 25.853, UNI 9177 classe 1, US Cal. Bull. 117-2013

---

**Frame, accessories**



**M009 Aluminum**  
semi-matt RAL9006



**M015 White**  
semi-matt RAL9010



**M154 Anthracite**  
semi-matt RAL7043



**M115 Black**  
semi-matt RAL9005

---