

Ogi V

technical specification



.mdd

MDD has a leading position among manufacturers of office furniture with many awards that prove quality and continuously increase demand for it's products.

The realities of today`s market require constant quality improvement at all levels of modern organization. This applies in particular to customer service, marketing, quality of products and also to quality of processes within the company. Partnership relations among employees and with business partners form a base of economic growth and success of the company.

Constant investments in innovative machinery park, optimization of management systems and an expansion of production halls allow to minimize the lead times for the product of the highest quality.

More than twenty years of experience in office furniture industry come with reference from a long list of companies and institutions to show their appreciation for an efficient and comprehensive service.

MDD is highly aware of the environment.

Being located in the forest region with lake by it's side, MDD takes the nature seriously and invests constantly in a modern and energy-efficient solutions to preserve the local life. Company puts emphasis on waste segregation and recycling. MDD has been awarded for the exceptional care and involvement in waste disposal. All materials used are environmentally friendly and enjoy a high 95 % rate of being recycled.



General informations:

Warranty:

MDD products – **5 years**.
Electrical components and fabric – **2 years**.

Certificate - MFC:



Compliant with standards:

PN-EN 527-2:2017-02

Boards density:

12 mm - 690 - 750 kg/m³
18 mm - 650 - 690 kg/m³
28 mm - 610 - 630 kg/m³
36 mm - 610 - 630 kg/m³

Assembly:

product delivered in separate elements

Packing:

cardboard

Ogi desk worktops

1. **Worktop** - MFC 28 mm, ABS edge

OPTIONS WITH EXTRA CHARGE:

2. **Grommet** - 2 pcs, Ø 80 mm

3. **Mediabox M04H** - 2xRJ45 (class E, cat. 6); +1 x USB + 1 x HDMI + 4x 230V, colour: M009 - aluminium semi-matt

4. **Mediabox M04** - 2xRJ45 (class E, cat. 6); +1 x USB + 4x 230V, colour: M009 - aluminium semi-matt

5. **Top access M05** - colour: M009 - aluminium semi-matt

6. **Cable way** - in bench type desks, the width of the opening is proportional to the width of the worktop

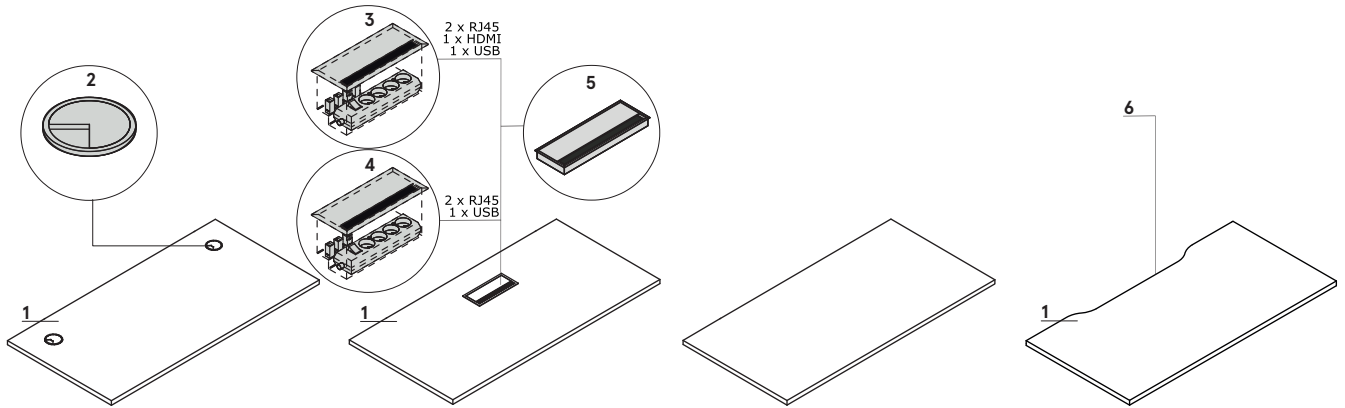

Dimensions of the worktop with scallops (mm)

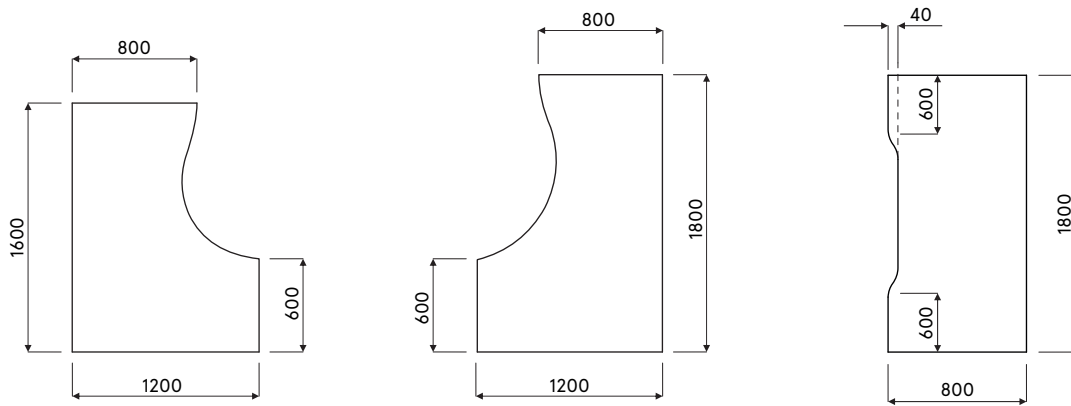

Frame

Ogi V: legs - MFC 28 mm, modesty panel - MFC 18 mm, aluminum spacer 60x20 mm between top and leg

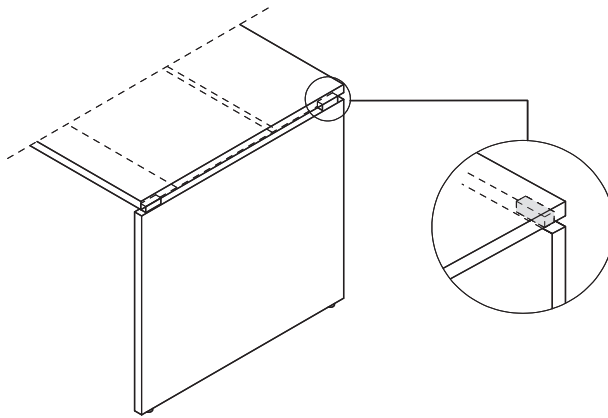

Accessories

1. Horizontal cable tray S69 - powder coated, colour: 09 - aluminum
2. Single desk horizontal cable tray (SG12, SG16) - powder coated metal, colour: M009 - aluminum semi-matt
3. Horizontal cable tray E64 - powder coated, colour: M009 - aluminium semi-matt

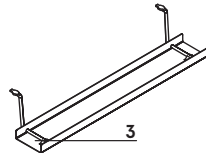
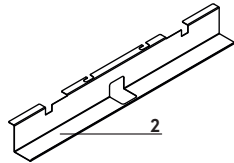
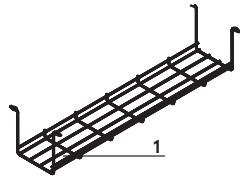

Desks

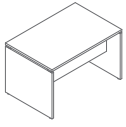

BVG02
1200 / 800 / 740
45.2 kg

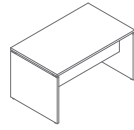

BVG03
1400 / 800 / 740
49.6 kg

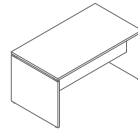

BVG04
1600 / 800 / 740
53.5 kg

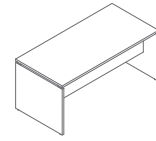

BVG05
1800 / 800 / 740
57.9 kg

Radial desks

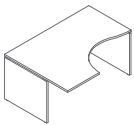

BVG10
1600 / 1200 / 740
57.5 kg

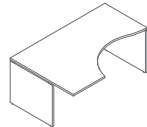

BVG17
1800 / 1200 / 740
65.5 kg

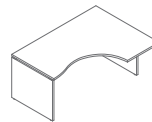

BVG11
1600 / 1200 / 740
57.5 kg

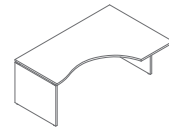

BVG18
1800 / 1200 / 740
65.5 kg

Worktop, top, base, body, front

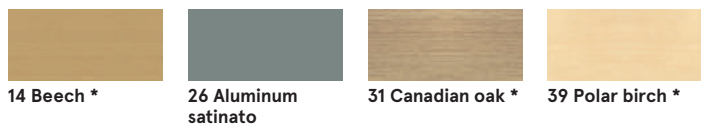

14 Beech * 26 Aluminum satinato 31 Canadian oak * 39 Polar birch *

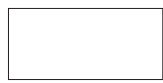

67 White pastel

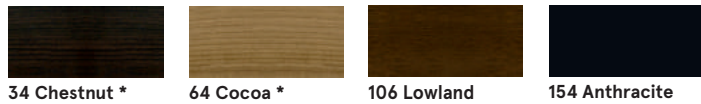

34 Chestnut * 64 Cocoa * 106 Lowland walnut * 154 Anthracite



08 Black 167 Grey oak 168 Natural oak

Grommet

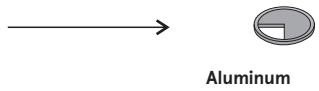

Aluminum

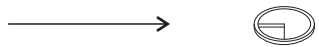

White

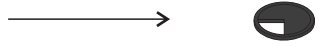

Black

Frame - metal



M009 Aluminum semi-matt RAL9006 M015 White semi-matt RAL9010 M154 Antracite semi-matt RAL7043 M115 Black semi-matt RAL9005

* body - II group