

Ogi U

technical specification



.mdd

MDD has a leading position among manufacturers of office furniture with many awards that prove quality and continuously increase demand for its products.

The realities of today's market require constant quality improvement at all levels of modern organization. This applies in particular to customer service, marketing, quality of products and also to quality of processes within the company.

Partnership relations among employees and with business partners form a base of economic growth and success of the company.

Constant investments in innovative machinery park, optimization of management systems and an expansion of production halls allow to minimize the lead times for the product of the highest quality.

More than twenty years of experience in office furniture industry come with reference from a long list of companies and institutions to show their appreciation for an efficient and comprehensive service.

MDD is highly aware of the environment.

Being located in the forest region with lake by its side, MDD takes the nature seriously and invests constantly in a modern and energy-efficient solutions to preserve the local life. Company puts emphasis on waste segregation and recycling. MDD has been awarded for the exceptional care and involvement in waste disposal. All materials used are environmentally friendly and enjoy a high 95 % rate of being recycled.



General informations:

Warranty:

MDD products – **5 years.**

Electrical components and fabric – **2 years.**

Certificate - MFC:



Compliant with standards:

PN-EN 527-2:2017-02

Boards density:

12 mm - 690 - 750 kg/m³

18 mm - 650 - 690 kg/m³

28 mm - 610 - 630 kg/m³

36 mm - 610 - 630 kg/m³

Assembly:

product delivered in separate elements

Packing:

cardboard, perforated plastic mesh wrap

Ogi desk worktops

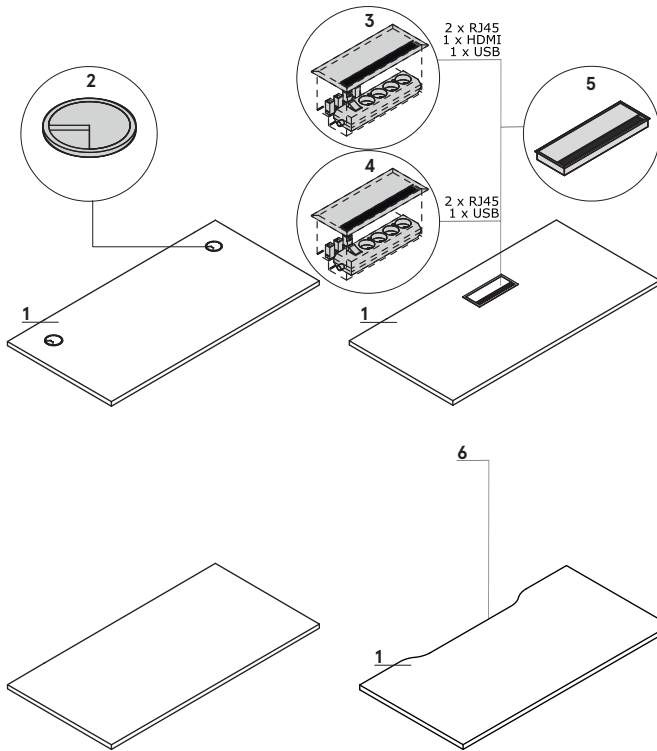

1. Worktop - MFC 28 mm, ABS edge

OPTIONS WITH EXTRA CHARGE:

2. Grommet - 2 pcs, Ø 80 mm

3. Mediabox M04H - 2xRJ45 (class E, cat. 6); +1 x USB + 1 x HDMI + 4x 230V, colour: M009 - aluminium semi-matt

4. Mediabox M04 - 2xRJ45 (class E, cat. 6); +1 x USB + 4x 230V, colour: M009 - aluminium semi-matt

5. Top access M05 - colour: M009 - aluminium semi-matt

6. Cable way - in bench type desks, the width of the opening is proportional to the width of the worktop

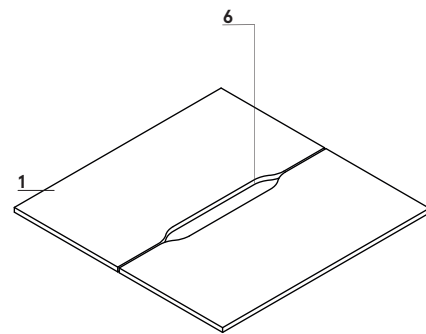

Dimensions of radial worktops (mm)

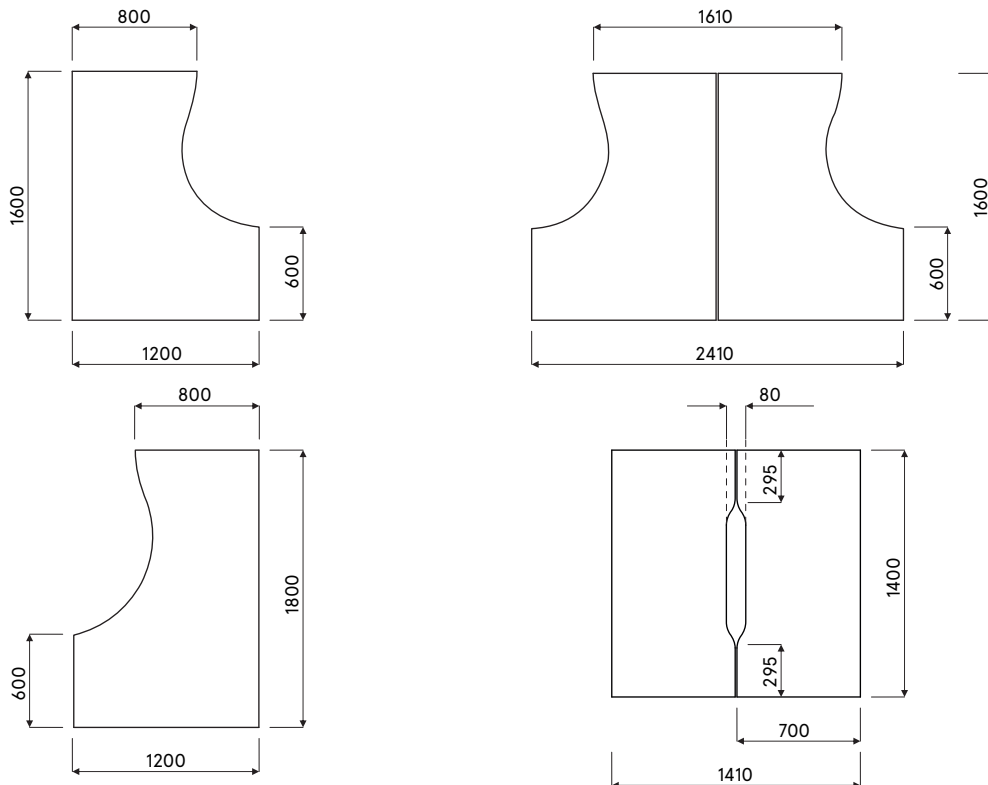

Frame

Ogi U: powder coated steel, profile 60x30 mm, spacer 10 mm between top and frame

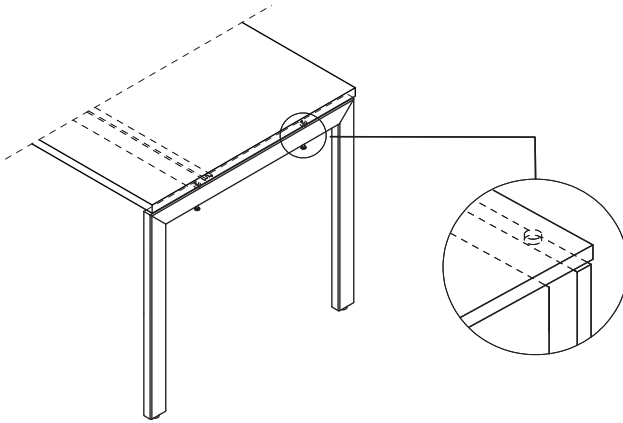

Desk with managerial storage

- 1. Worktop - MFC 28 mm, ABS edge
- 2. Top - MFC 28 mm, ABS edge
- 3. Shelf - MFC 18 mm, protection against accidental falling-out, ABS edge
- 4. Drawer - MFC 18 mm, ABS edge, patent lock - possible to change location
- 5. Base - MFC 18 mm, ABS edge
- 6. Front - MFC 18 mm, ABS edge

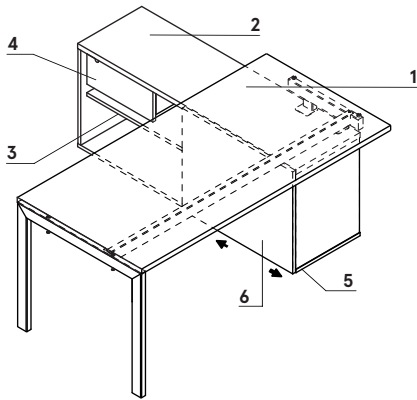

www.mdd.eu

Configuration examples (mm)

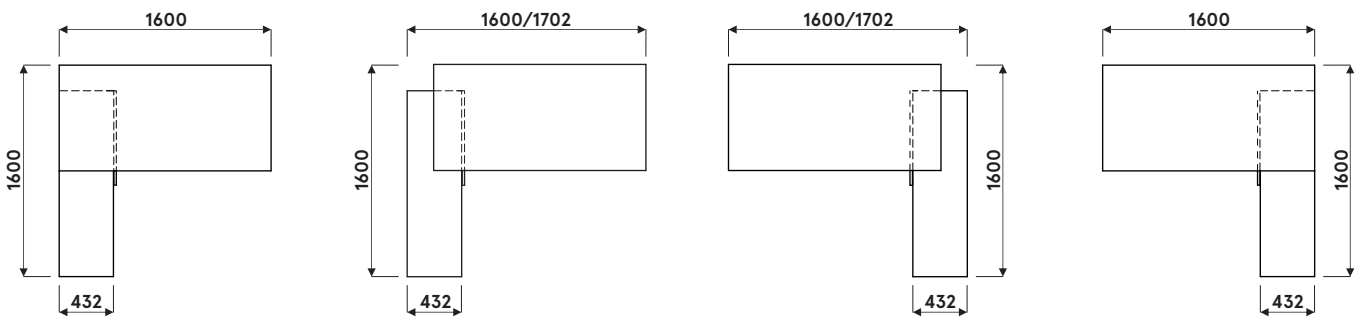

Configuration examples (mm)

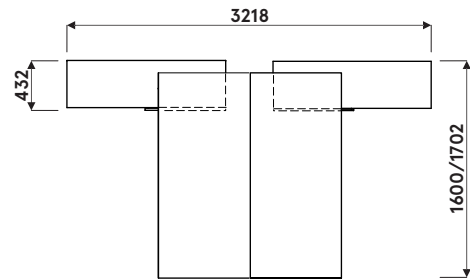
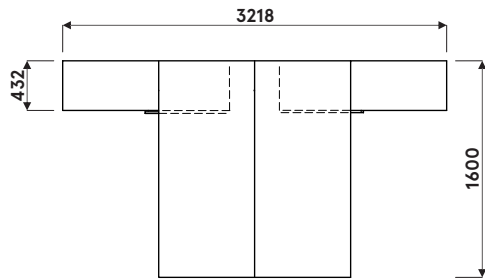

Configuration examples with BOX40, BOX50, BOX60

www.mdd.eu

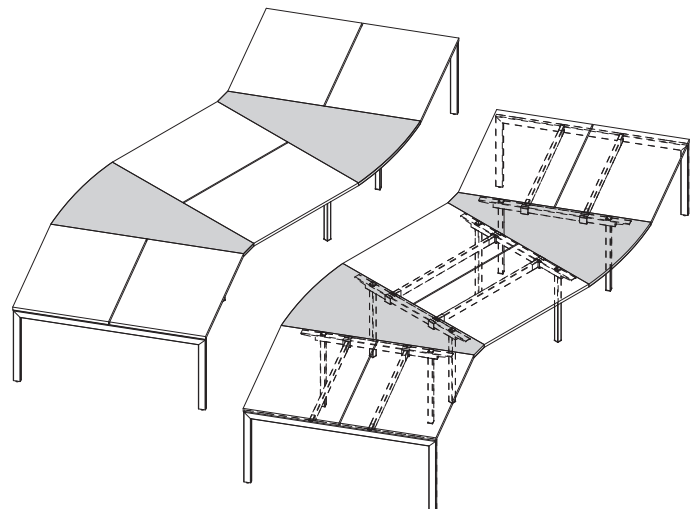
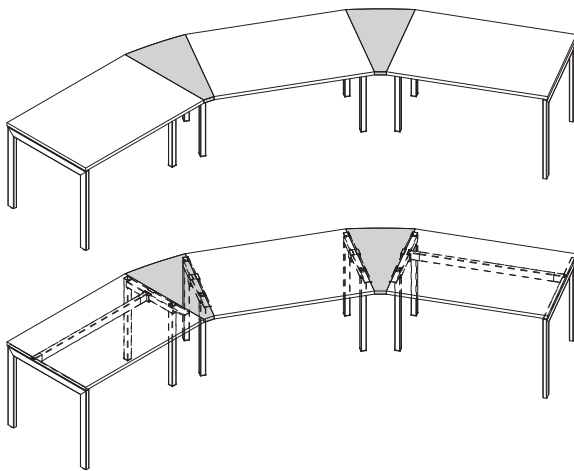

ATTENTION - only for Ogi Q, Ogi U, Ogi Y, Ogi M

Accessories

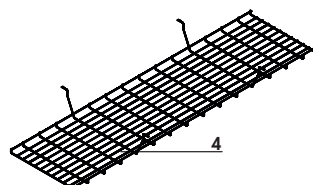
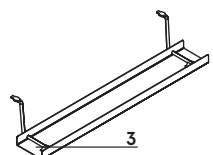
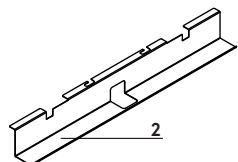
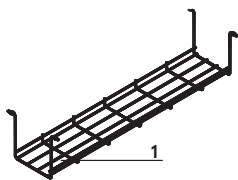

1. Horizontal cable tray S69 - powder coated, colour: 09 - aluminum
2. Single desk horizontal cable tray (SG12, SG16) - powder coated metal, colour: M009 - aluminum semi-matt
3. Horizontal cable tray E64 - powder coated, colour: M009 - aluminium semi-matt
4. Cable tray for bench desks (SG220, SG260) - steel wire Ø4 mm, powder coated, colour: 09 - aluminum

Desks



BOU12
1200 / 600 / 740
29.7 kg



BOU14
1400 / 600 / 740
32.8 kg

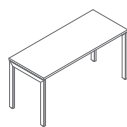

BOU16
1600 / 600 / 740
35.9 kg



BOU28
1200 / 700 / 740
32.3 kg



BOU29
1400 / 700 / 740
35.7 kg

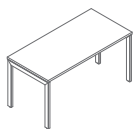

BOU30
1600 / 700 / 740
39.3 kg



BOU19
1200 / 800 / 740
37.8 kg

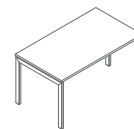

BOU20
1400 / 800 / 740
38.3 kg

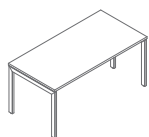

BOU21
1600 / 800 / 740
38.9 kg

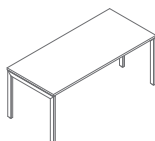

BOU22
1800 / 800 / 740
42 kg

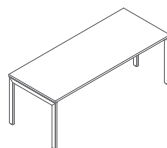

BOU27
2000 / 800 / 740
49.7 kg

www.mdd.eu

Elements for arrangement building - straight desk



BOX40
500 / 800 / 740
10.8 kg

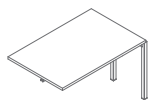

BOX42
1200 / 800 / 740
31.6 kg

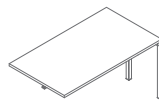

BOX43
1400 / 800 / 740
32.1 kg

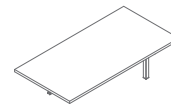

BOX44
1600 / 800 / 740
32.7 kg

Elements for arrangement building - straight desk

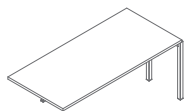

BOX45
1600 / 800 / 740
35.8 kg

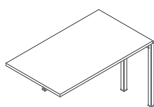

BOX32
1200 / 700 / 740
26.3 kg

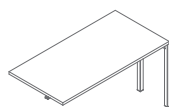

BOX34
1400 / 700 / 740
29.7 kg

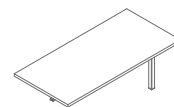

BOX36
1600 / 700 / 740
33.3 kg

Radial desks

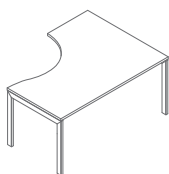

BOU23
1600 / 1200 / 740
46.1 kg

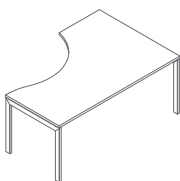

BOU25
1800 / 1200 / 740
42 kg

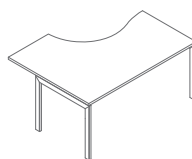

BOU24
1600 / 1200 / 740
46.1 kg

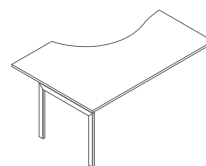

BOU26
1800 / 1200 / 740
44 kg

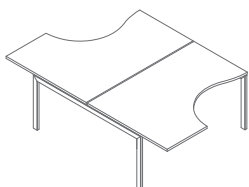

BOU15
1600 / 2410 / 740
85.5 kg

www.mdd.eu

Desks with managerial storage

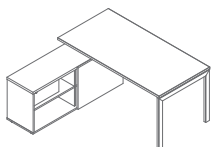

BOUL20
1600-1702 / 1600 / 740
92.9 kg

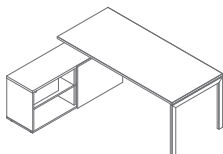

BOUL21
1800-1902 / 1600 / 740
96 kg

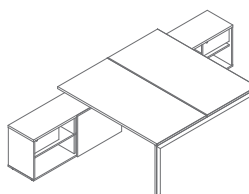

BOUL40
1600-1702 / 3210 / 740
182.6 kg

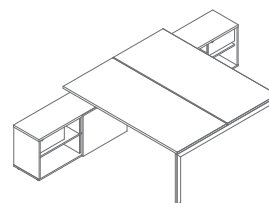

BOUL41
1800-1902 / 3210 / 740
188.8 kg

Bench desks

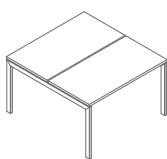

BOU42
1200 / 1410 / 740
57.1 kg

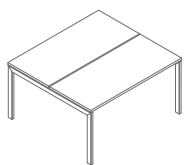

BOU44
1400 / 1410 / 740
63.9 kg

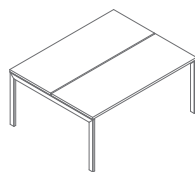

BOU46
1600 / 1410 / 740
71.1 kg

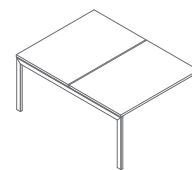

BOU32
1200 / 1610 / 740
68.9 kg

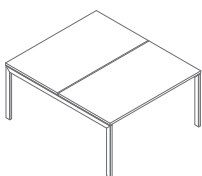

BOU33
1400 / 1610 / 740
69.9 kg

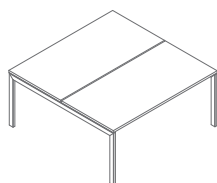

BOU34
1600 / 1610 / 740
71.1 kg

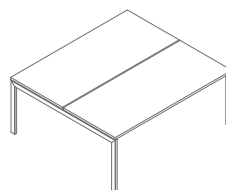

BOU35
1800 / 1610 / 740
77.3 kg

Elements for arrangement building - bench



BOX50
1000 / 1410 / 740
16.5 kg

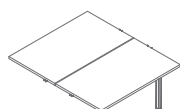

BOX52
1200 / 1410 / 740
49.4 kg

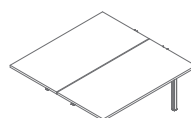

BOX54
1400 / 1410 / 740
56.2 kg

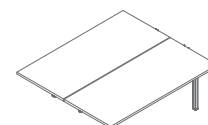

BOX56
1600 / 1410 / 740
63.4 kg

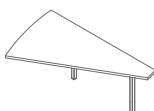

BOX60
1000 / 1610 / 740
17.5 kg

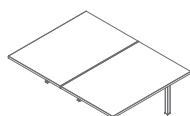

BOX62
1200 / 1610 / 740
60.1 kg

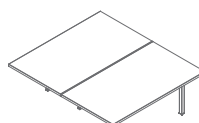

BOX64
1400 / 1610 / 740
61.1 kg

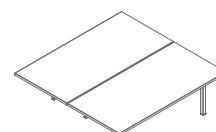

BOX66
1600 / 1610 / 740
62.3 kg

Elements for arrangement building - bench

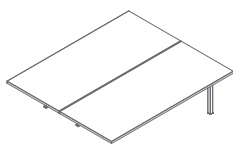

BOX68
1800 / 1610 / 740
68,5 kg

Desk extensions

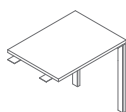

PLU01
600 / 800 / 740
18.4 kg

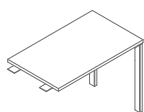

PLU02
600 / 1000 / 740
19.6 kg

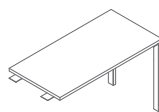

PLU03
600 / 1200 / 740
22.1 kg

Worktop, top, base, body, front



Grommet

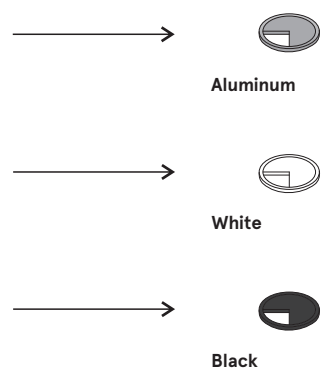

Frame - metal



* body - II group