

# Ogi Q

## technical specification



.mdd

**MDD has a leading position among manufacturers of office furniture with many awards that prove quality and continuously increase demand for its products.**

The realities of today's market require constant quality improvement at all levels of modern organization. This applies in particular to customer service, marketing, quality of products and also to quality of processes within the company.

Partnership relations among employees and with business partners form a base of economic growth and success of the company.

Constant investments in innovative machinery park, optimization of management systems and an expansion of production halls allow to minimize the lead times for the product of the highest quality.

**More than twenty years of experience in office furniture industry come with reference from a long list of companies and institutions to show their appreciation for an efficient and comprehensive service.**

**MDD is highly aware of the environment.**

Being located in the forest region with lake by its side, MDD takes the nature seriously and invests constantly in a modern and energy-efficient solutions to preserve the local life. Company puts emphasis on waste segregation and recycling. MDD has been awarded for the exceptional care and involvement in waste disposal. All materials used are environmentally friendly and enjoy a high 95 % rate of being recycled.



## General informations:

### Warranty:

MDD products – **5 years.**

Electrical components and fabric – **2 years.**

### Certificate - MFC:



### Compliant with standards:

PN-EN 527-2:2017-02

### Boards density:

12 mm - 690 - 750 kg/m<sup>3</sup>

18 mm - 650 - 690 kg/m<sup>3</sup>

28 mm - 610 - 630 kg/m<sup>3</sup>

36 mm - 610 - 630 kg/m<sup>3</sup>

### Assembly:

product delivered in separate elements

### Packing:

cardboard, perforated plastic mesh wrap

Ogi desk worktops

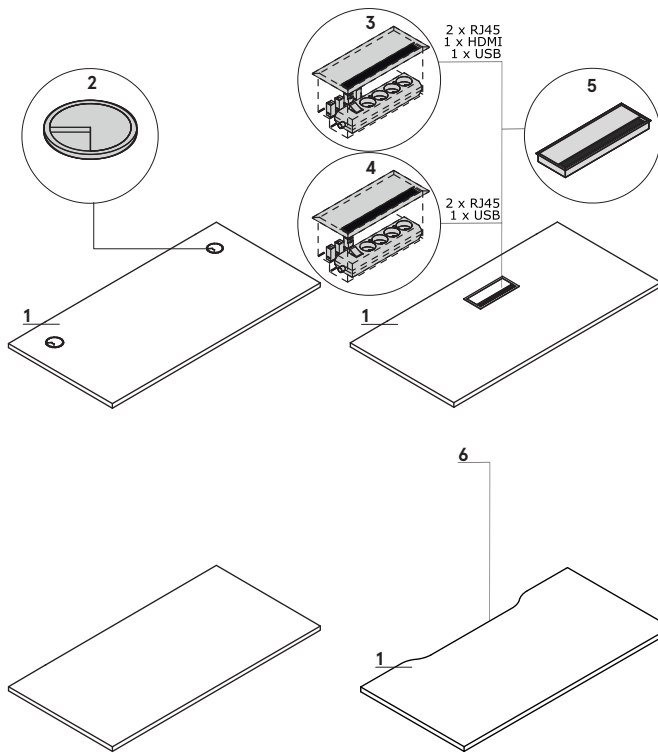

- 1. **Worktop** - MFC 28 mm, ABS edge
- OPTIONS WITH EXTRA CHARGE:**
- 2. **Grommet** - 2 pcs, Ø 80 mm
- 3. **Mediabox M04H** - 2xRJ45 (class E, cat. 6); +1 x USB + 1 x HDMI + 4x 230V, colour: M009 - aluminium semi-matt
- 4. **Mediabox M04** - 2xRJ45 (class E, cat. 6); +1 x USB + 4x 230V, colour: M009 - aluminium semi-matt
- 5. **Top access M05** - colour: M009 - aluminium semi-matt
- 6. **Cable way** - in bench type desks, the width of the opening is proportional to the width of the worktop

Dimensions of the worktop with scallops

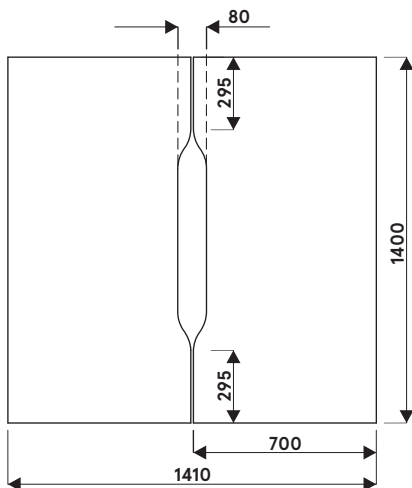

Frame

Ogi Q: powder coated steel, profile 60x20 mm, spacer 10 mm between top and frame

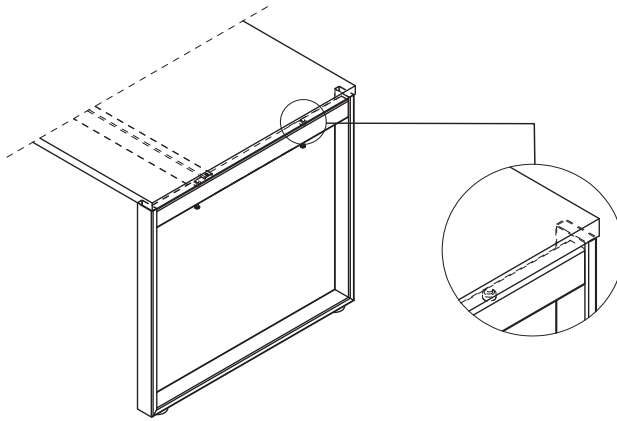

Desk with managerial storage

- 1. Worktop - MFC 28 mm, ABS edge
- 2. Top - MFC 28 mm, ABS edge
- 3. Shelf - MFC 18 mm, protection against accidental falling-out, ABS edge
- 4. Drawer - MFC 18 mm, ABS edge, patent lock - possible to change location
- 5. Base - MFC 18 mm, ABS edge
- 6. Front - MFC 18 mm, ABS edge

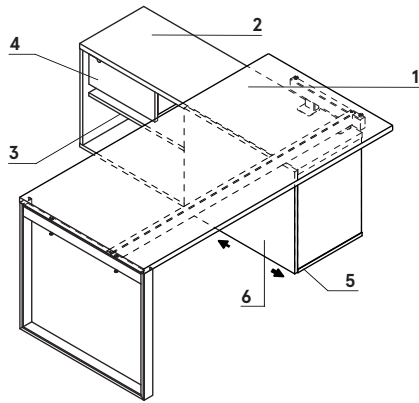

www.mdd.eu

Configuration examples (mm)

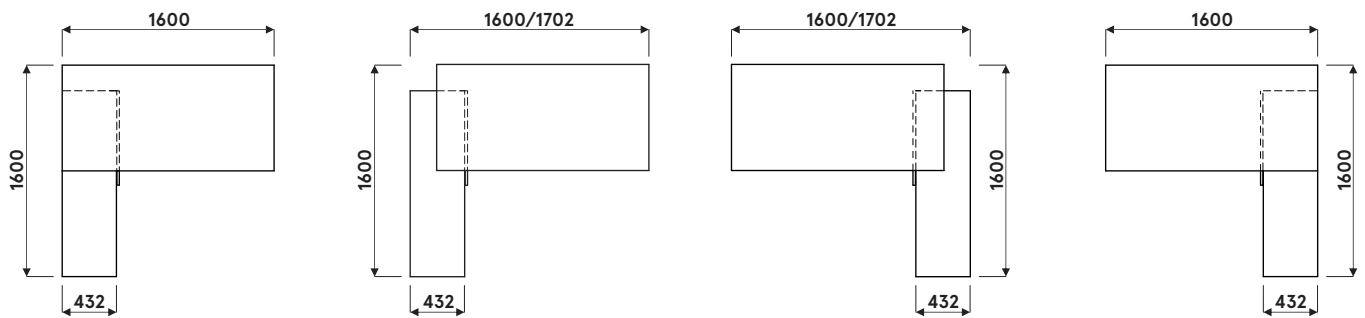

Configuration examples (mm)

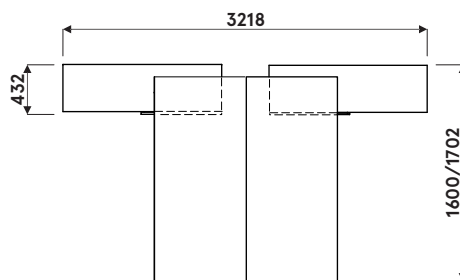
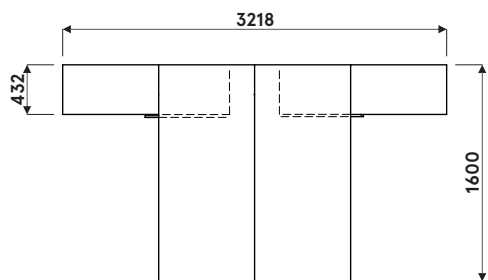

Configuration examples with BOX40, BOX50, BOX60

www.mdd.eu

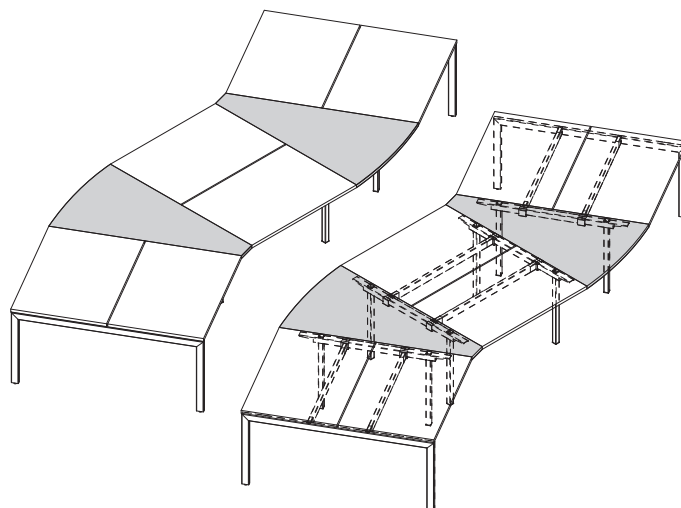
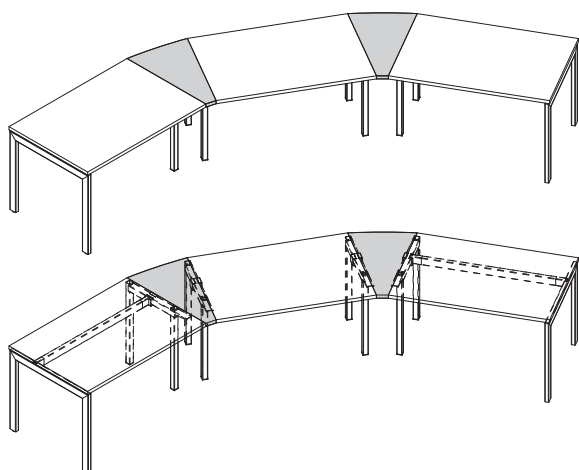

ATTENTION - only for Ogi Q, Ogi U, Ogi Y, Ogi M

Accessories

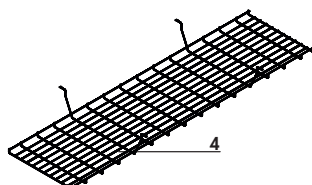
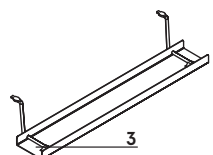
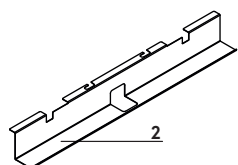
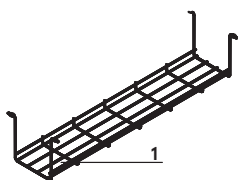

1. Horizontal cable tray S69 - powder coated, colour: 09 - aluminum
2. Single desk horizontal cable tray (SG12, SG16) - powder coated metal, colour: M009 - aluminum semi-matt
3. Horizontal cable tray E64 - powder coated, colour: M009 - aluminium semi-matt
4. Cable tray for bench desks (SG220, SG260) - steel wire Ø4 mm, powder coated, colour: 09 - aluminum

Desks

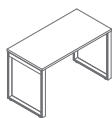

**BOQ12**  
1200 / 600 / 740  
31.9 kg

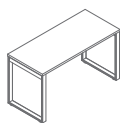

**BOQ14**  
1400 / 600 / 740  
35 kg

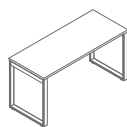

**BOQ16**  
1600 / 600 / 740  
38.1 kg

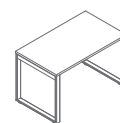

**BOQ22**  
1200 / 700 / 740  
35.5 kg

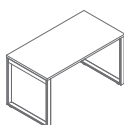

**BOQ24**  
1400 / 700 / 740  
38.9 kg

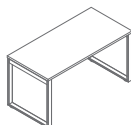

**BOQ26**  
1600 / 700 / 740  
42.5 kg

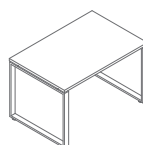

**BOQ02**  
1200 / 800 / 740  
41 kg

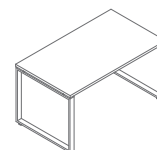

**BOQ03**  
1400 / 800 / 740  
41.5 kg

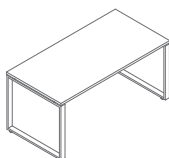

**BOQ04**  
1600 / 800 / 740  
42.1 kg

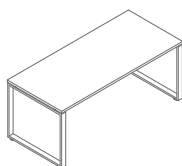

**BOQ05**  
1800 / 800 / 740  
45.2 kg

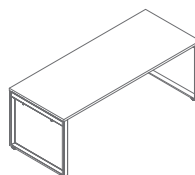

**BOQ06**  
2000 / 800 / 740  
51.5 kg

www.mdd.eu

Elements for arrangement building - straight desk



**BOX40**  
500 / 800 / 740  
10.8 kg

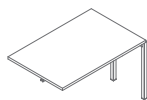

**BOX42**  
1200 / 800 / 740  
31.6 kg

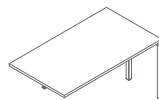

**BOX43**  
1400 / 800 / 740  
32.1 kg

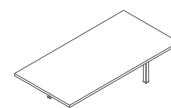

**BOX44**  
1600 / 800 / 740  
32.7 kg

Elements for arrangement building - straight desk

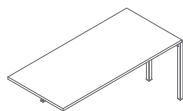

**BOX45**  
1600 / 800 / 740  
35.8 kg

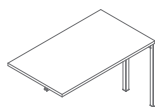

**BOX32**  
1200 / 700 / 740  
26.3 kg

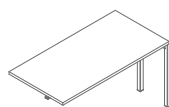

**BOX34**  
1400 / 700 / 740  
29.7 kg

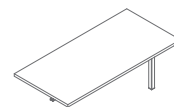

**BOX36**  
1600 / 700 / 740  
33.3 kg

Bench desks

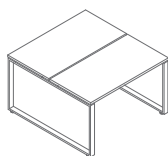

**BOQ42**  
1200 / 1410 / 740  
51.9 kg

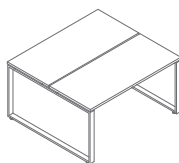

**BOQ44**  
1400 / 1410 / 740  
58.7 kg

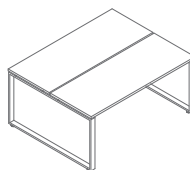

**BOQ46**  
1600 / 1410 / 740  
65.9 kg

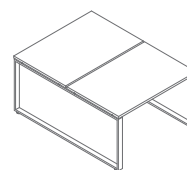

**BOQ32**  
1200 / 1610 / 740  
61 kg

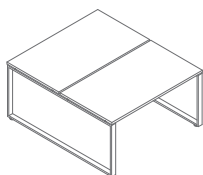

**BOQ33**  
1400 / 1610 / 740  
62.6 kg

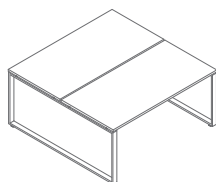

**BOQ34**  
1600 / 1610 / 740  
63.8 kg

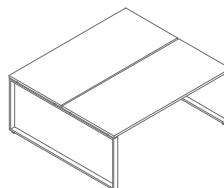

**BOQ35**  
1800 / 1610 / 740  
70 kg

www.mdd.eu

Elements for arrangement building - bench

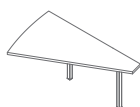

**BOX50**  
1000 / 1410 / 740  
16.5 kg

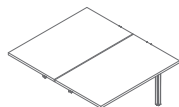

**BOX52**  
1200 / 1410 / 740  
49.4 kg

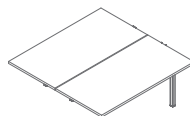

**BOX54**  
1400 / 1410 / 740  
56.2 kg

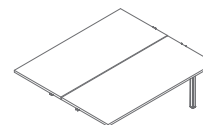

**BOX56**  
1600 / 1410 / 740  
63.4 kg

Elements for arrangement building - bench

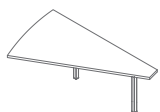

**BOX60**  
1000 / 1610 / 740  
17,5 kg

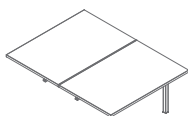

**BOX62**  
1200 / 1610 / 740  
60,1 kg

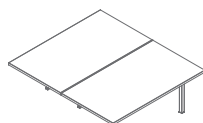

**BOX64**  
1400 / 1610 / 740  
61,1 kg

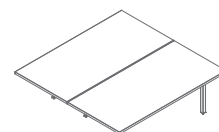

**BOX66**  
1600 / 1610 / 740  
62,3 kg

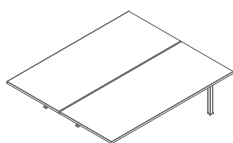

**BOX68**  
1800 / 1610 / 740  
68,5 kg

Desks with managerial storage

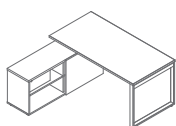

**BOQL20**  
1600-1702 / 1600 / 740  
94,4 kg

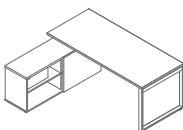

**BOQL21**  
1800-1902 / 1600 / 740  
97,5 kg

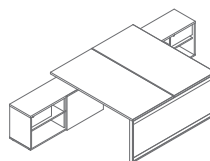

**BOQL40**  
1600-1702 / 3210 / 740  
185,8 kg

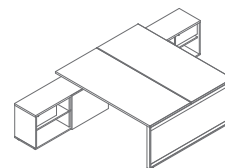

**BOQL41**  
1800-1902 / 3210 / 740  
192 kg

Desk extensions

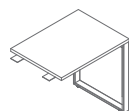

**PLQ01**  
600 / 800 / 740  
19,5 kg

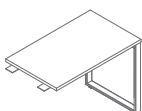

**PLQ02**  
600 / 1000 / 740  
20,7 kg

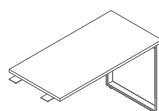

**PLQ03**  
600 / 1200 / 740  
23,2 kg



Worktop, top, base, body, front



Grommet

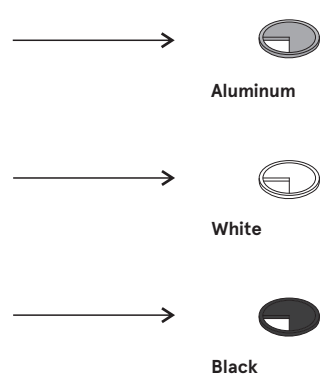

Frame - metal

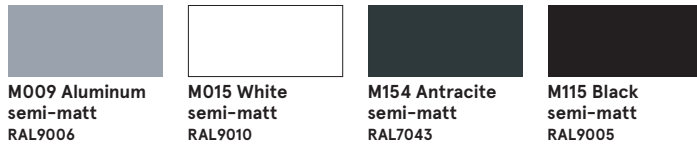

\* body - II group