

Ogi A

technical specification



.mdd

MDD has a leading position among manufacturers of office furniture with many awards that prove quality and continuously increase demand for its products.

The realities of today's market require constant quality improvement at all levels of modern organization. This applies in particular to customer service, marketing, quality of products and also to quality of processes within the company.

Partnership relations among employees and with business partners form a base of economic growth and success of the company.

Constant investments in innovative machinery park, optimization of management systems and an expansion of production halls allow to minimize the lead times for the product of the highest quality.

More than twenty years of experience in office furniture industry come with reference from a long list of companies and institutions to show their appreciation for an efficient and comprehensive service.

MDD is highly aware of the environment.

Being located in the forest region with lake by its side, MDD takes the nature seriously and invests constantly in a modern and energy-efficient solutions to preserve the local life. Company puts emphasis on waste segregation and recycling. MDD has been awarded for the exceptional care and involvement in waste disposal. All materials used are environmentally friendly and enjoy a high 95 % rate of being recycled.



General informations:

Warranty:

MDD products – **5 years.**

Electrical components and fabric – **2 years.**

Certificate - MFC:



Compliant with standards:

PN-EN 527-2:2017-02

Boards density:

12 mm - 690 - 750 kg/m³

18 mm - 650 - 690 kg/m³

28 mm - 610 - 630 kg/m³

36 mm - 610 - 630 kg/m³

Assembly:

product delivered in separate elements

Packing:

cardboard, perforated plastic mesh wrap

Ogi desk worktops

1. **Worktop** - MFC 28 mm, ABS edge

OPTIONS WITH EXTRA CHARGE:

2. **Grommet** - 2 pcs, Ø 80 mm

3. **Mediabox M04H** - 2xRJ45 (class E, cat. 6); +1 x USB + 1 x HDMI + 4x 230V, colour: M009 - aluminium semi-matt

4. **Mediabox M04** - 2xRJ45 (class E, cat. 6); +1 x USB + 4x 230V, colour: M009 - aluminium semi-matt

5. **Top access M05** - colour: M009 - aluminium semi-matt

6. **Cable way** - in bench type desks, the width of the opening is proportional to the width of the worktop

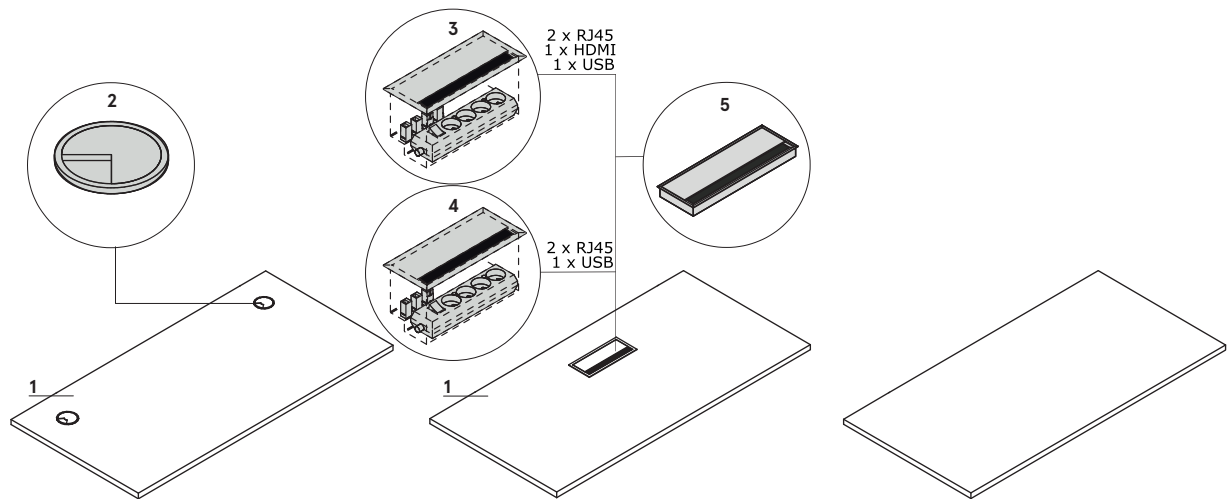

Dimensions of radial worktops (mm)

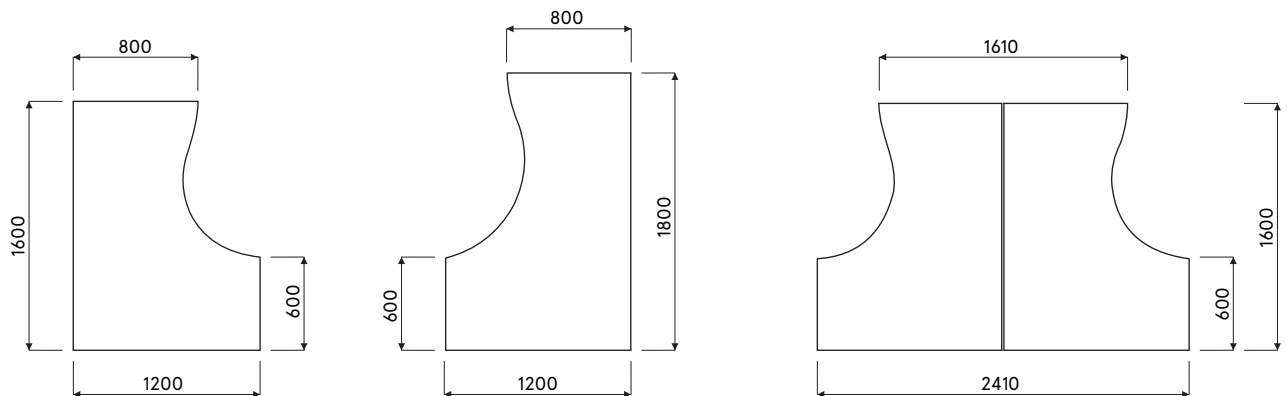

Frame

Ogi A: powder coated steel, profile 60x30 mm

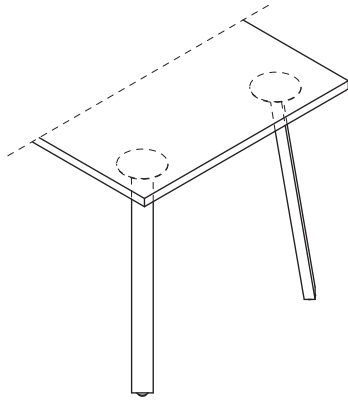

Accessories

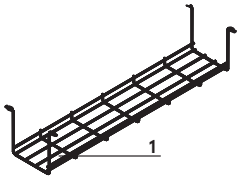

1. Horizontal cable tray S69 - powder coated, colour: 09 - aluminum
2. Single desk horizontal cable tray (SG12, SG16) - powder coated metal, colour: M009 - aluminum semi-matt
3. Horizontal cable tray E64 - powder coated, colour: M009 - aluminium semi-matt
4. Cable tray for bench desks (SG220, SG260) - steel wire Ø4 mm, powder coated, colour: 09 - aluminum

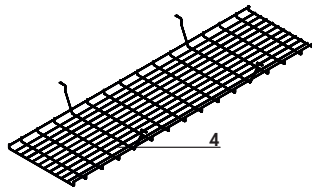
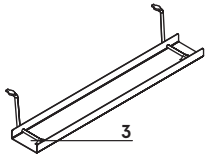
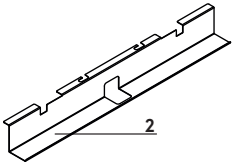

Desks



BAG026
1200 / 600 / 740
25 kg



BAG036
1400 / 600 / 740
26 kg



BAG046
1600 / 600 / 740
27.6 kg



BAG027
1200 / 700 / 740
24 kg



BAG037
1400 / 700 / 740
27 kg



BAG047
1600 / 700 / 740
29 kg



BAG028
1200 / 800 / 740
27 kg



BAG038
1400 / 800 / 740
29 kg



BAG048
1600 / 800 / 740
32 kg

www.mdd.eu

Radial desks

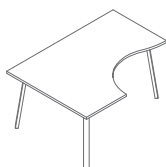

BAG10
1600 / 1200 / 740
37 kg

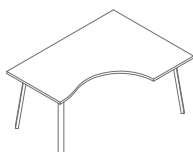

BAG11
1600 / 1200 / 740
37 kg

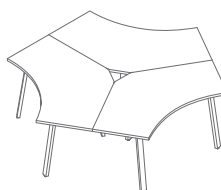

BAG12
2343 / 2029 / 740
93.6 kg

Bench desks

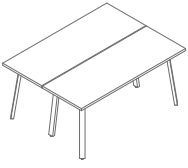

BAG0214
1600 / 1210 / 740
48 kg

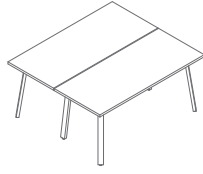

BAG0216
1600 / 1410 / 740
54 kg

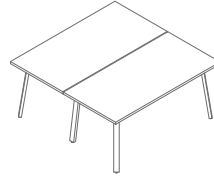

BAG0218
1600 / 1610 / 740
60 kg

Elements for desks pairing

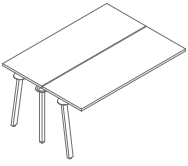

BAG0414
1600 / 1210 / 740
42 kg

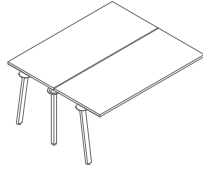

BAG0416
1600 / 1410 / 740
48 kg

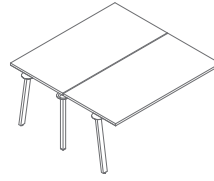

BAG0418
1600 / 1610 / 740
54 kg

Worktop

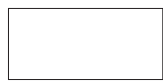
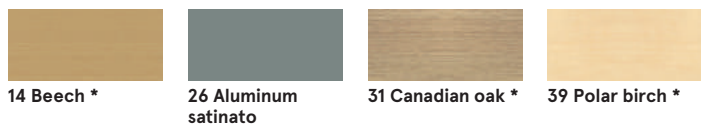

67 White pastel



08 Black

167 Grey oak

168 Natural oak

Grommet

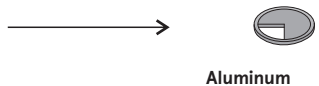

Aluminum

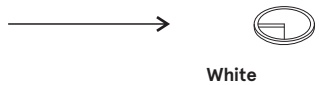

White

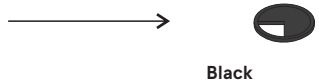

Black

Frame - metal



* body - II group