

Ogi Drive technical specification



.mdd

.mdd has a leading position among manufacturers of office furniture with many awards that prove quality and continuously increase demand for its products.

The realities of today's market require constant quality improvement at all levels of modern organization. This applies in particular to customer service, marketing, quality of products and also to quality of processes within the company.

Partnership relations among employees and with business partners form a base of economic growth and success of the company.

Constant investments in innovative machinery park, optimization of management systems and an expansion of production halls allow to minimize the lead times for the product of the highest quality.

More than twenty years of experience in office furniture industry come with reference from a long list of companies and institutions to show their appreciation for an efficient and comprehensive service.

.mdd is highly aware of the environment.

Being located in the forest region with lake by its side, .mdd takes the nature seriously and invests constantly in a modern and energy-efficient solutions to preserve the local life. Company puts emphasis on waste segregation and recycling. .mdd has been awarded for the exceptional care and involvement in waste disposal. All materials used are environmentally friendly and enjoy a high 95 % rate of being recycled.



General informations:

Warranty:

.mdd products – **5 years.**

Electrical components and fabric – **2 years.**

Certificate - MFC:



Assembly:

product delivered in separate elements

Packing:

cardboard

Compliant with standards:

DIN EN 13849-1:2007, Performance Level B;

RoSH 2011/65/UE;

LVD; EU Directive 2006/95/EC;

EMC according to EU Directive 2004/108/EC;

PN-EN 55014-1:2017-06;

PN-EN 55014-2:2015-06;

PN-EN 60204-1:2010P;

PN-EN 61000-1-2:2016-11;

PN-EN 61000-6-3:2008/A1:2012;

PN-EN 60335-1:2012;

PN-EN-ISO-12100_2012P

Boards density:

12 mm – 690 – 750 kg/m³

18 mm – 650 – 690 kg/m³

28 mm – 610 – 630 kg/m³

36 mm – 610 – 630 kg/m³

Ogi desk worktops

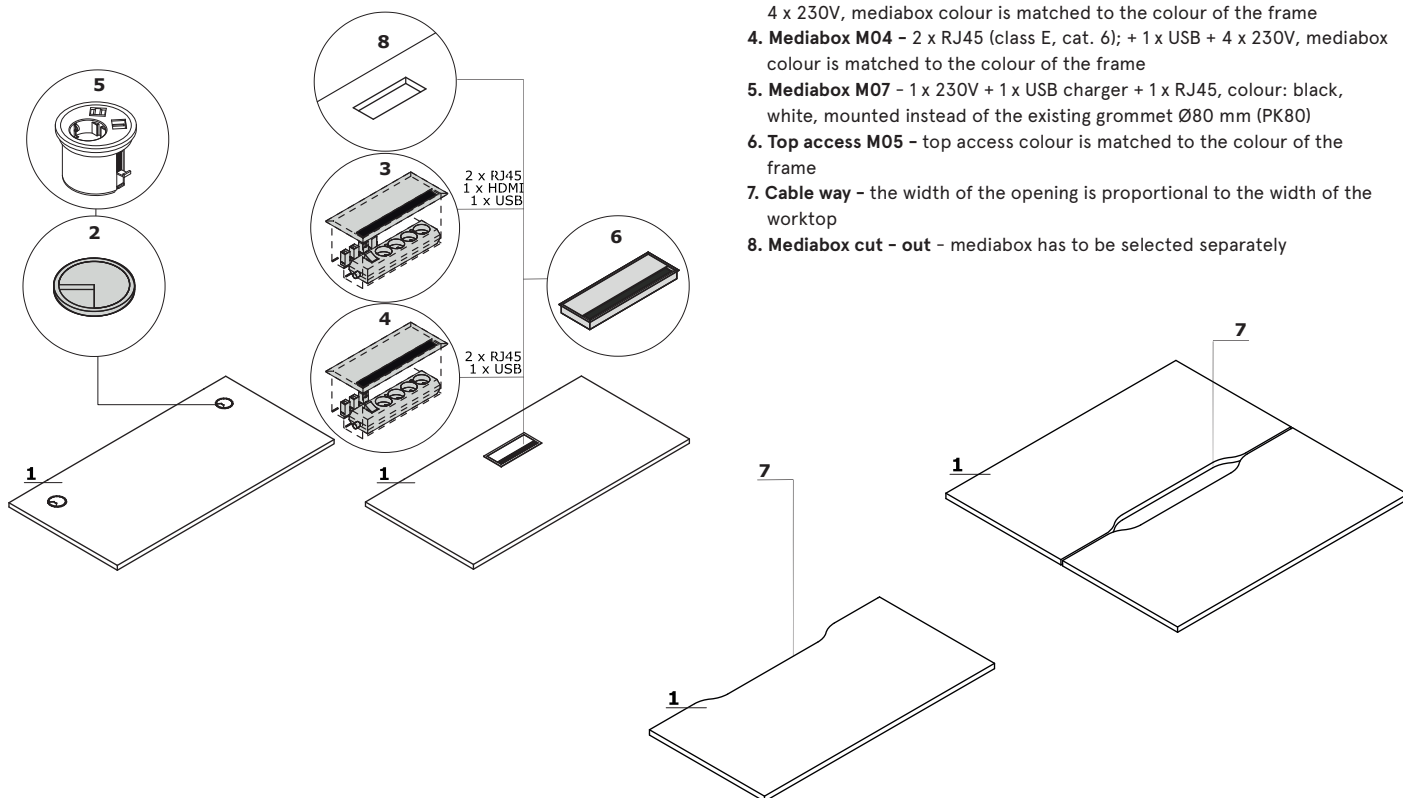

1. **Worktop** - MFC 28 mm, ABS edge
- OPTIONS WITH EXTRA CHARGE:**
2. **Grommet** - 2 pcs, Ø 80 mm
3. **Mediabox M04H** - 2 x RJ45 (class E, cat. 6); + 1 x USB + 1 x HDMI + 4 x 230V, mediabox colour is matched to the colour of the frame
4. **Mediabox M04** - 2 x RJ45 (class E, cat. 6); + 1 x USB + 4 x 230V, mediabox colour is matched to the colour of the frame
5. **Mediabox M07** - 1 x 230V + 1 x USB charger + 1 x RJ45, colour: black, white, mounted instead of the existing grommet Ø80 mm (PK80)
6. **Top access M05** - top access colour is matched to the colour of the frame
7. **Cable way** - the width of the opening is proportional to the width of the worktop
8. **Mediabox cut - out** - mediabox has to be selected separately

Frame

1. **Ogi Drive with electric height adjustment** - in the range of 650-1300 mm, metal, powder coated, 3 profiles 50 × 50 mm, 55 × 55 mm and 60 × 60 mm
2. **Ogi Drive with electric height adjustment** - in the range of 700-1200 mm, metal, powder coated, 2 profiles 55 × 55 mm and 60 × 60 mm
3. **OPTION WITH EXTRA CHARGE** - Pro foot:
 - aluminium powder coated
 - polished aluminium

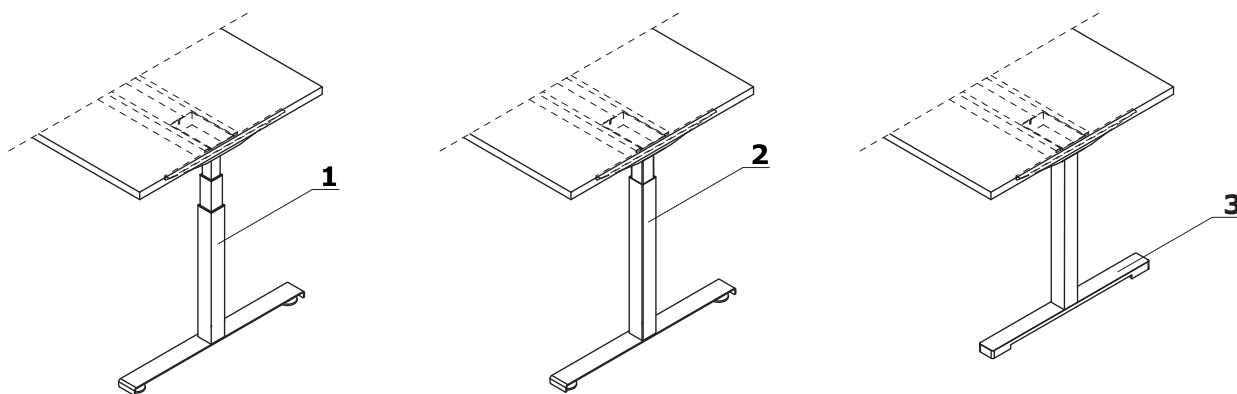

Electric height adjustable frame - Ogi Drive

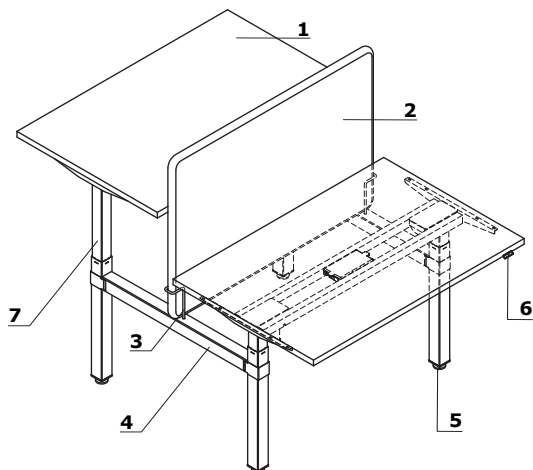

ATTENTION - distance between bench worktops 90 mm

1. **Worktop** - MFC 28 mm, ABS edge
2. **ZD Panel** - acoustic class A, zip fastener, pinable
3. **Fixing element** - powder coated metal
4. **Metal element for legs connecting**
5. **Leveling feet** - range 5 mm
6. **Control panel** - stepless height adjustment:
 - A - basic control panel; the sensitivity of the anti-collision system is set to Medium
 - B - OPTION WITH EXTRA CHARGE - up and down keypad with memory; the ability to change the sensitivity of the anti-collision system within 3 levels: Low, Medium, High
 - C - OPTION WITH EXTRA CHARGE - round control panel with memory; the ability to change the sensitivity of the anti-collision system within 3 levels: Low, Medium, High; mounted to the worktop
 - D - OPTION FOR AN ADDITIONAL COST - bluetooth module:
 - * compatible with both panel A and B
 - * the ability to change the sensitivity of the anti-collision system within 3 levels: Low, Medium, High
 - * control via MDD Desk BT application (downloadable from Google Play or App Store). The app has a time interval function that informs the user about the need of changing body position (from sitting to standing or standing to sitting)
7. **Electric height adjustable frame** - powder coated steel, load 100 kg, telescopic leg

A

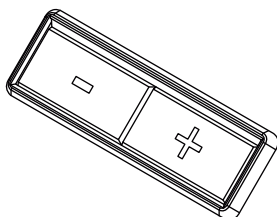

B

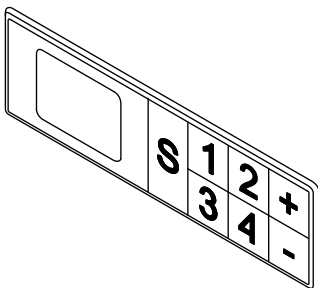

C

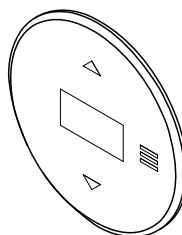

D

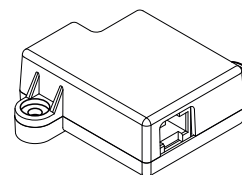

Frame technical specification

- **Height adjustment** - 40 mm/sec Super Soft Start - Stop
- **Drive** - 2 synchronised motors with microprocessor, work control sensor
- **Noise level** - < 48dB
- **Anti collision mechanism**
- **Standards** - EN 527-2
- **EU Directives** - 206/95EC, UI508 1999, UL 1004 R7 06, WE DC 2004/108WE Stand - by mode 0.3 W
- **Power supply** - 230V, 256W

Ogi Drive	Date of preparation 15.12.2021	The data contained in this document is valid in the day of its preparation. Change of the product, as long as it does not affect the basic features of it, does not require consistent updates of the document.	page 4/13 technical description
-----------	-----------------------------------	---	---

Electric frame with common cable tray - Ogi Drive

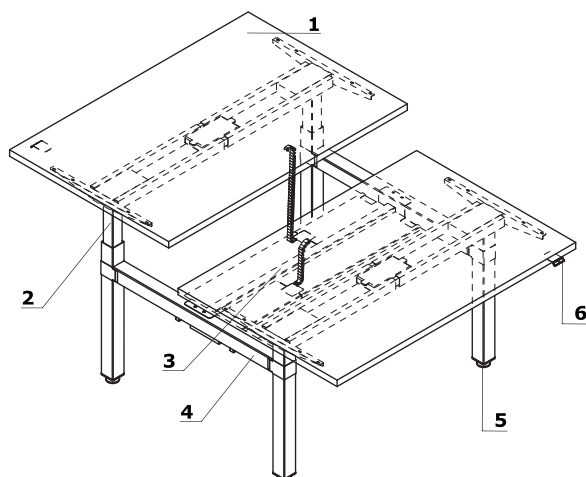

1. **Worktop** - MFC 28 mm, ABS edge
2. **Electric height adjustable frame** - powder coated steel, load 100 kg, telescopic leg
3. **Common cable tray + vertical cable organizer**
4. **Metal element for legs connecting**
5. **Leveling feet** - range 5 mm
6. **Control panel** - stepless height adjustment:
 - A - basic control panel; the sensitivity of the anti-collision system is set to Medium
 - B - OPTION WITH EXTRA CHARGE - up and down keypad with memory; the ability to change the sensitivity of the anti-collision system within 3 levels: Low, Medium, High
 - C - OPTION WITH EXTRA CHARGE - round control panel with memory; the ability to change the sensitivity of the anti-collision system within 3 levels: Low, Medium, High; mounted to the worktop
 - D - OPTION FOR AN ADDITIONAL COST - bluetooth module - compatible with control panel A and B - control via MDD Desk BT application (downloadable from Google Play or App Store). The app has a time interval function that informs the user about the need of changing body position (from sitting to standing or standing to sitting)

Mediabox location

- A - left mediabox
- B - left/right mediabox
- C - right mediabox

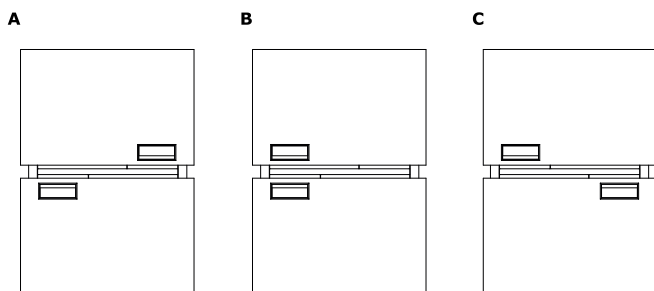

Accessories

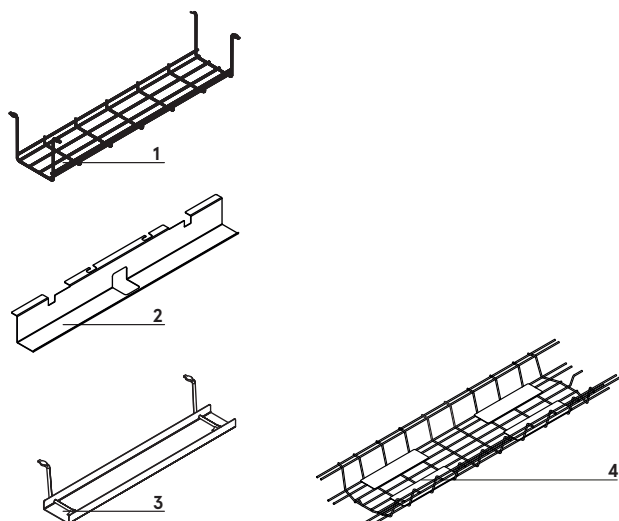

1. **Horizontal cable tray S69** - powder coated, colour: 09 - aluminum
2. **Single desk horizontal cable tray (SG12, SG16)** - powder coated metal, colour: M009 - aluminum semi-matt
3. **Horizontal cable tray E64** - powder coated, colour: M009 - aluminium semi-matt
4. **Cable tray for bench desks Ogi Drive (SOD12, SOD14, SOD16, SOD18, SOD20)** - powder coated, colour: M009 - aluminium semi-matt

Ogi Drive handle - dimensions (mm)

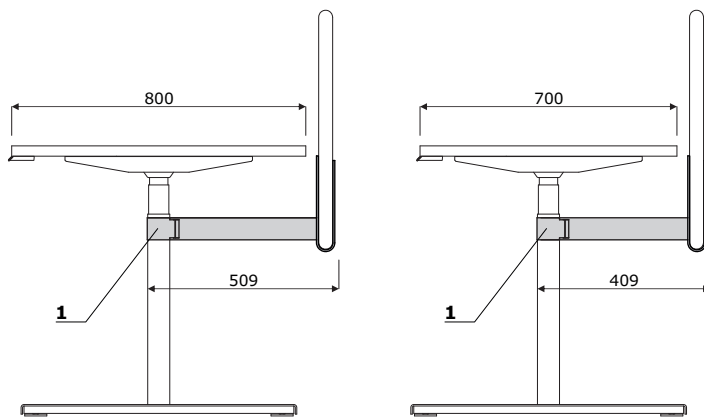

1. **Ogi Drive screen bracket** - an option with extra charge; mountable to the frame; powder-coated metal, 60x60mm profile

Caution - Ogi Drive screen bracket does not allow for pairing with screens equipped with accessories rail.

Power strip - for series connection

1. **PWS1** - set for 1 workstation - power strip (3x SCHUCKO, 2x RJ45) x1 + power cord (universal outlet PL/FR/Schucko)
2. **PWS2** - set for 2 workstation - power strip (3x SCHUCKO, 2x RJ45) x2 + set of power cords (universal outlet PL/FR/Schucko)
3. **PWS3** - set for 3 workstation - power strip (3x SCHUCKO, 2x RJ45) x3 + set of power cords (universal outlet PL/FR/Schucko)

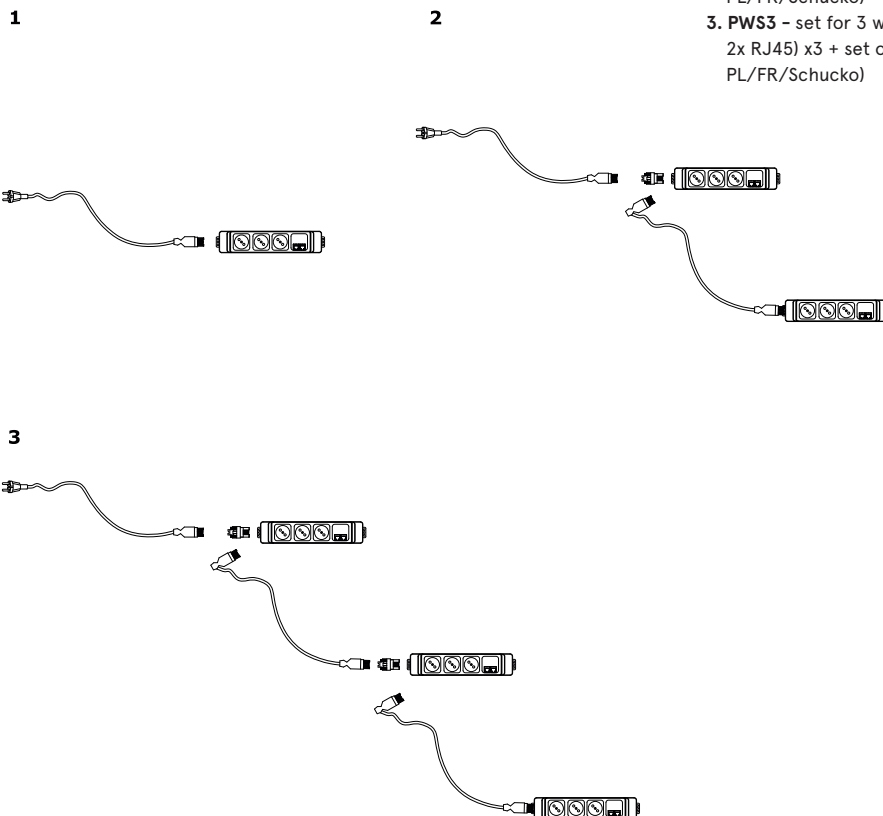

Simple desks electric height adjustment in the range of 700-1200 mm - sit-stand *



BOD527
1200 / 700 / 700-1200
42.1 kg

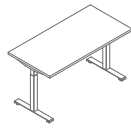

BOD547
1400 / 700 / 700-1200
45.8 kg

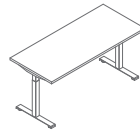

BOD567
1600 / 700 / 700-1200
49.3 kg

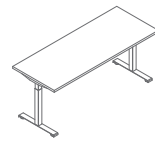

BOD587
1800 / 700 / 700-1200
53.3 kg

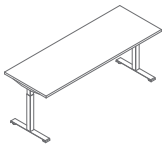

BOD607
2000 / 700 / 700-1200
57.3 kg



BOD52
1200 / 800 / 700-1200
45.65 kg

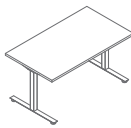

BOD54
1400 / 800 / 700-1200
50.5 kg

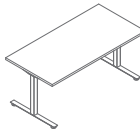

BOD56
1600 / 800 / 700-1200
54.15 kg

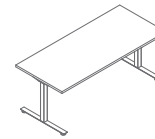

BOD58
1800 / 800 / 700-1200
58.45 kg

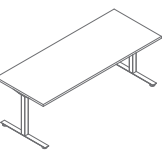

BOD60
2000 / 800 / 700-1200
62.25 kg

* dimensions expressed in millimeters: width x depth x height

Single desks with electric height adjustment in the range of 650-1300 mm - sit-stand *



BOD627
1200 / 700 / 650-1300
424.63 kg



BOD647
1400 / 700 / 650-1300
48.33 kg



BOD667
1600 / 700 / 650-1300
51.83 kg

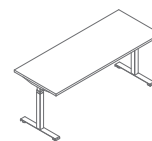

BOD687
1800 / 700 / 650-1300
55.83 kg

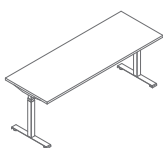

BOD707
2000 / 700 / 650-1300
59.83 kg

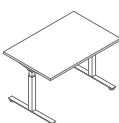

BOD62
1200 / 800 / 650-1300
48.18 kg

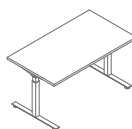

BOD64
1400 / 800 / 650-1300
53.03 kg

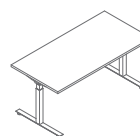

BOD66
1600 / 800 / 650-1300
56.68 kg

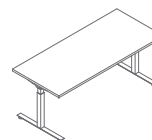

BOD68
1800 / 800 / 650-1300
60.98 kg

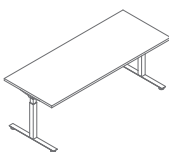

BOD70
2000 / 800 / 650-1300
64.78 kg

* dimensions expressed in millimeters: width x depth x height

Bench desks with electric height adjustment in the range of 700-1200 mm - sit-stand *

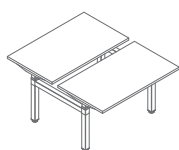

BOD572
1200 / 1490 / 700-1200
83.2 kg

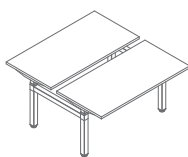

BOD574
1400 / 1490 / 700-1200
89.6 kg

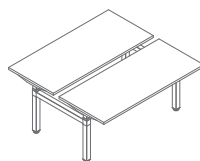

BOD576
1600 / 1490 / 700-1200
95.6 kg

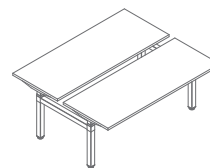

BOD578
1800 / 1490 / 700-1200
102.6 kg

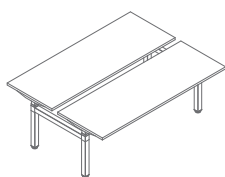

BOD570
2000 / 1490 / 700-1200
109.6 kg

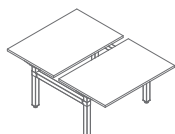

BOD512
1200 / 1690 / 700-1200
90.8 kg

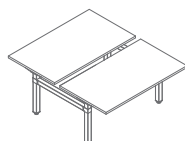

BOD514
1400 / 1690 / 700-1200
99.5 kg

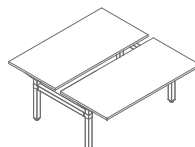

BOD516
1600 / 1690 / 700-1200
105.8 kg

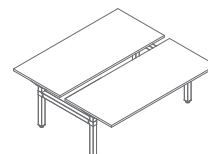

BOD518
1800 / 1690 / 700-1200
113.4 kg

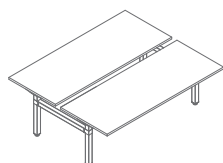

BOD520
2000 / 1690 / 700-1200
120 kg

* dimensions expressed in millimeters: width x depth x height

Bench desks with electric height adjustment in the range of 650-1300 mm - sit-stand *

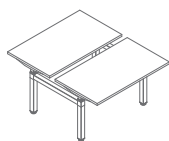

BOD672
1200 / 1490 / 650-1300
88.26 kg

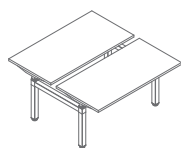

BOD674
1400 / 1490 / 650-1300
94.66 kg

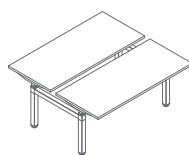

BOD676
1600 / 1490 / 650-1300
100.66 kg

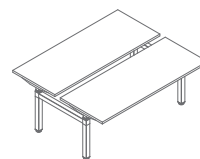

BOD678
1800 / 1490 / 650-1300
107.66 kg

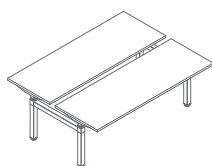

BOD670
2000 / 1490 / 650-1300
114.66 kg

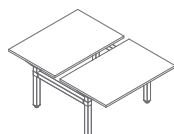

BOD612
1200 / 1690 / 650-1300
95.86 kg

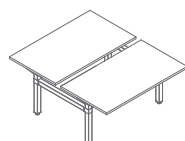

BOD614
1400 / 1690 / 650-1300
104.56 kg

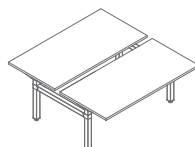

BOD616
1600 / 1690 / 650-1300
110.86 kg

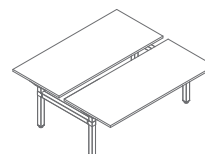

BOD618
1800 / 1690 / 650-1300
118.46 kg

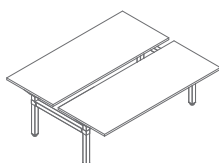

BOD620
2000 / 1690 / 650-1300
125.06 kg

* dimensions expressed in millimeters: width x depth x height

Bench desks with common cable tray *

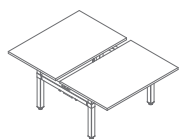

BOD712
1200 / 1690 / 700-1200
97.8 kg

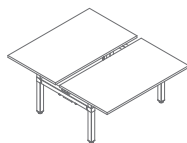

BOD714
1400 / 1690 / 700-1200
108 kg

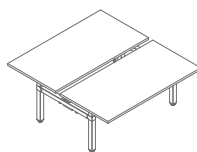

BOD716
1600 / 1690 / 700-1200
115.8 kg

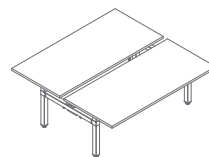

BOD718
1800 / 1690 / 700-1200
124.4 kg

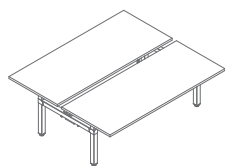

BOD720
2000 / 1690 / 700-1200
133 kg

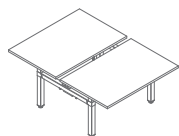

BOD812
1200 / 1690 / 650-1300
102.86 kg

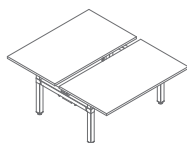

BOD814
1400 / 1690 / 650-1300
113.06 kg

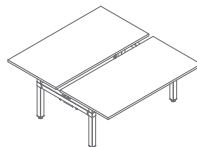

BOD816
1600 / 1690 / 650-1300
120.86 kg

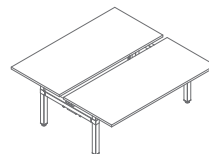

BOD818
1800 / 1690 / 650-1300
129.46 kg

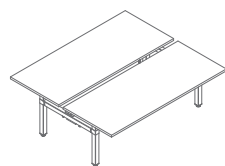

BOD820
2000 / 1690 / 650-1300
138.06 kg

* dimensions expressed in millimeters: width x depth x height

One leg desk electric height adjustment in the range of 650-1300 mm - sit-stand *

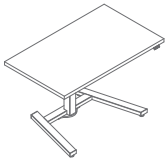

BOD100
1000 / 600 / 650-1300
24 kg

Sonic - acoustic screens for bench desks *

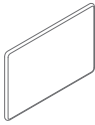

ZD812
1190 / 40 / 800
13.6 kg

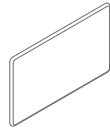

ZD814
1390 / 40 / 800
8.6 kg

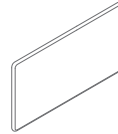

ZD816
1590 / 40 / 800
7.4 kg

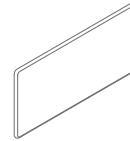

ZD818
1790 / 40 / 800
8.9 kg

www.mdd.eu

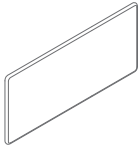

ZD820
1990 / 40 / 800
9.1 kg

Power strip



PWS1
500 / 430 / 569
1.1 kg



PWS2
500 / 430 / 569
1.6 kg

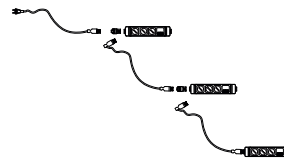

PWS3
500 / 430 / 569
2.1 kg

* dimensions expressed in millimeters: width x depth x height

Ogi Drive	Date of preparation 15.12.2021	The data contained in this document is valid in the day of its preparation. Change of the product, as long as it does not affect the basic features of it, does not require consistent updates of the document.	page 12/13
			products

Worktop



26 Aluminum satinato



31 Canadian oak *



39 Polar birch *

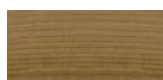

64 Cocoa *



168 Natural oak *



169 Honey oak*



170 Acacia *



67 White pastel



171 Dark walnut*

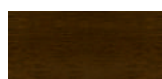

106 Lowland walnut *



154 Anthracite



08 Black



167 Grey oak *

Grommet



Aluminum



Beige



White



Black

Frame, mediabox - metal



M009 Aluminum semi-matt RAL9006



M015 White semi-matt RAL9010



M154 Antracite semi-matt RAL7043



M115 Black semi-matt RAL9005