

Meeting tables - Ogi Y technical specification



.mdd

MDD has a leading position among manufacturers of office furniture with many awards that prove quality and continuously increase demand for it's products.

The realities of today`s market require constant quality improvement at all levels of modern organization. This applies in particular to customer service, marketing, quality of products and also to quality of processes within the company.

Partnership relations among employees and with business partners form a base of economic growth and success of the company.

Constant investments in innovative machinery park, optimization of management systems and an expansion of production halls allow to minimize the lead times for the product of the highest quality.

More than twenty years of experience in office furniture industry come with reference from a long list of companies and institutions to show their appreciation for an efficient and comprehensive service.

MDD is highly aware of the environment.

Being located in the forest region with lake by it's side, MDD takes the nature seriously and invests constantly in a modern and energy-efficient solutions to preserve the local life. Company puts emphasis on waste segregation and recycling. MDD has been awarded for the exceptional care and involvement in waste disposal. All materials used are environmentally friendly and enjoy a high 95 % rate of being recycled.



General informations:

Warranty:

MDD products - **5 years.**

Electrical components and fabric - **2 years.**

Certificate - MFC:



Assembly:

product delivered in separate elements

Packing:

cartboard

Compliant with standards:

PN-EN 15372:2010

Boards density:

12 mm - 690 - 750 kg/m³

18 mm - 650 - 690 kg/m³

28 mm - 610 - 630 kg/m³

36 mm - 610 - 630 kg/m³

Worktop

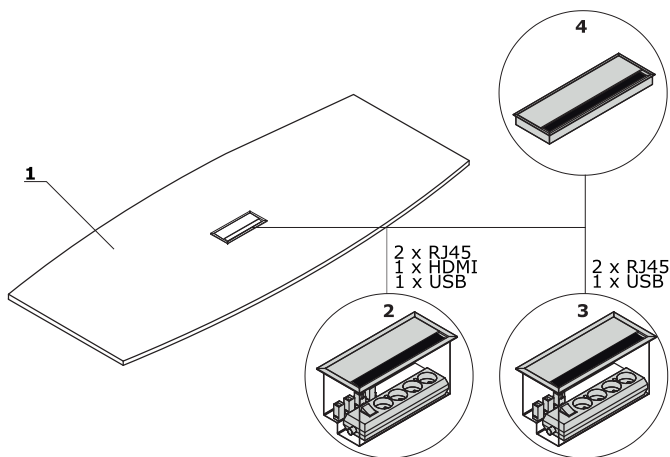

- 1. **Worktop** - MFC 28 mm, ABS edge
- OPTIONS WITH EXTRA CHARGE:**
- 2. **Mediabox M04H** - 2xRJ45 (class E, cat. 6); +1 x USB + 1 x HDMI + 4x 230V, colour: M009 - aluminium semi-matt
- 3. **Mediabox M04** - 2xRJ45 (class E, cat. 6); +1 x USB + 4x 230V, colour: M009 - aluminium semi-matt
- 4. **Top access M05** - colour: M009 - aluminium semi-matt

Frame - meeting tables Ogi Y

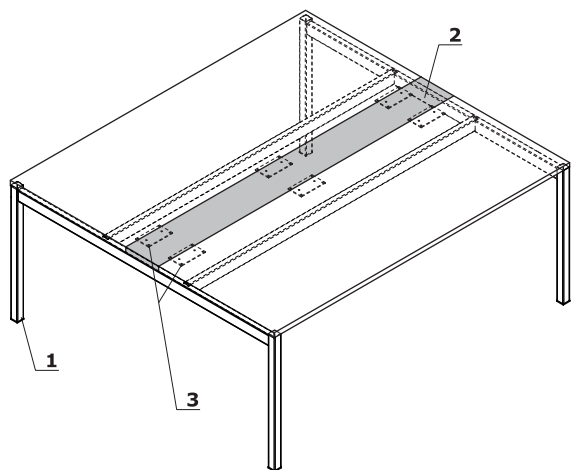

- 1. **Leg** - powder coated steel, profile 40x40 mm
- 2. **MFC element** - colour: 26 - aluminum satinato, 67 - white pastel, 154 - anthracite, 08 - black; without mediabox as standard
- 3. **Fixing flat bar**

www.mdd.eu

ATTENTION: MFC element matches with frame colour

Meeting tables - Ogi Y *

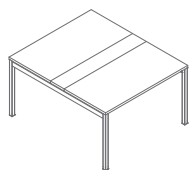

SY22
1200 / 1410 / 740
56.6 kg

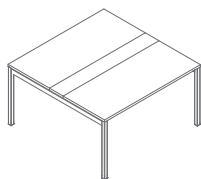

SY24
1400 / 1410 / 740
60.4 kg

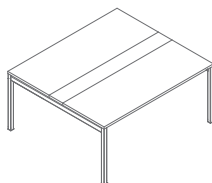

SY26
1600 / 1410 / 740
66.6 kg

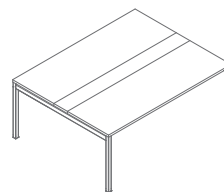

SY28
1800 / 1410 / 740
75.2 kg

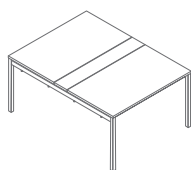

SY02
1200 / 1610 / 740
63.9 kg

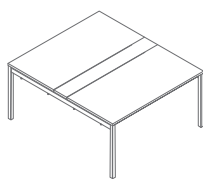

SY04
1400 / 1610 / 740
71.7 kg

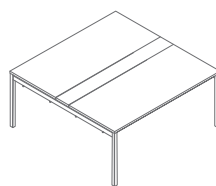

SY06
1600 / 1610 / 740
79.9 kg

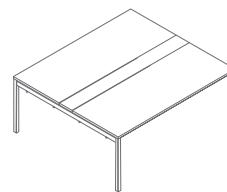

SY08
1800 / 1610 / 740
88.5 kg

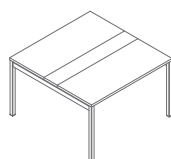

SY42
1200 / 1210 / 740
46.7 kg

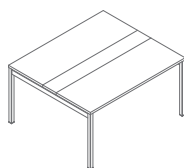

SY44
1400 / 1210 / 740
51.7 kg

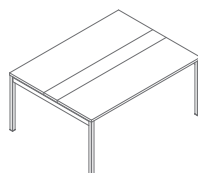

SY46
1600 / 1210 / 740
57.9 kg

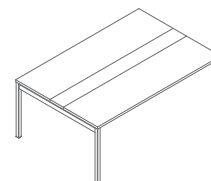

SY48
1800 / 1210 / 740
64.7 kg

* dimensions expressed in millimeters: width x depth x height

Elements for pairing - Ogi Y *

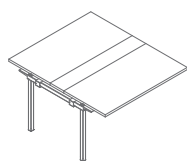

SY32
1200 / 1410 / 740
48.8 kg

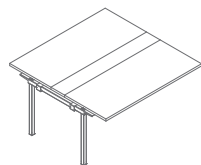

SY34
1400 / 1410 / 740
52.6 kg

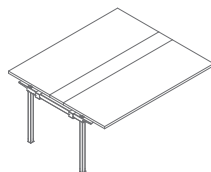

SY36
1600 / 1410 / 740
58.8 kg

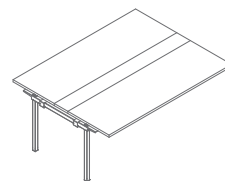

SY38
1800 / 1410 / 740
67.4 kg

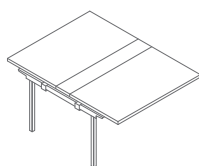

SY12
1200 / 1610 / 740
55.7 kg

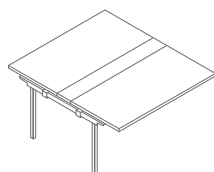

SY14
1400 / 1610 / 740
63.5 kg

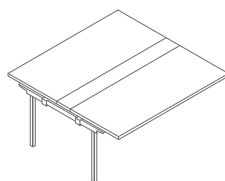

SY16
1600 / 1610 / 740
71.7 kg

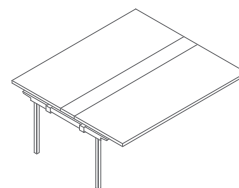

SY18
1800 / 1610 / 740
80.3 kg

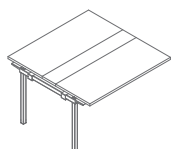

SY52
1200 / 1210 / 740
40 kg

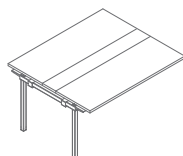

SY54
1400 / 1210 / 740
45 kg

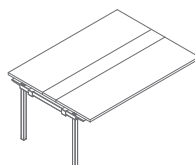

SY56
1600 / 1210 / 740
51.2 kg

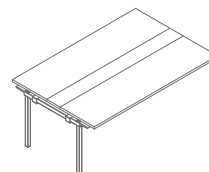

SY58
1800 / 1210 / 740
58 kg

Elements for pairing - Ogi Y *

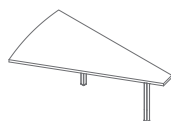

BOX60
1000 / 1610 / 740
17.5 kg

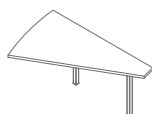

BOX50
1000 / 1410 / 740
16.5 kg

* dimensions expressed in millimeters: width x depth x height

Top



Frame

