

(A)

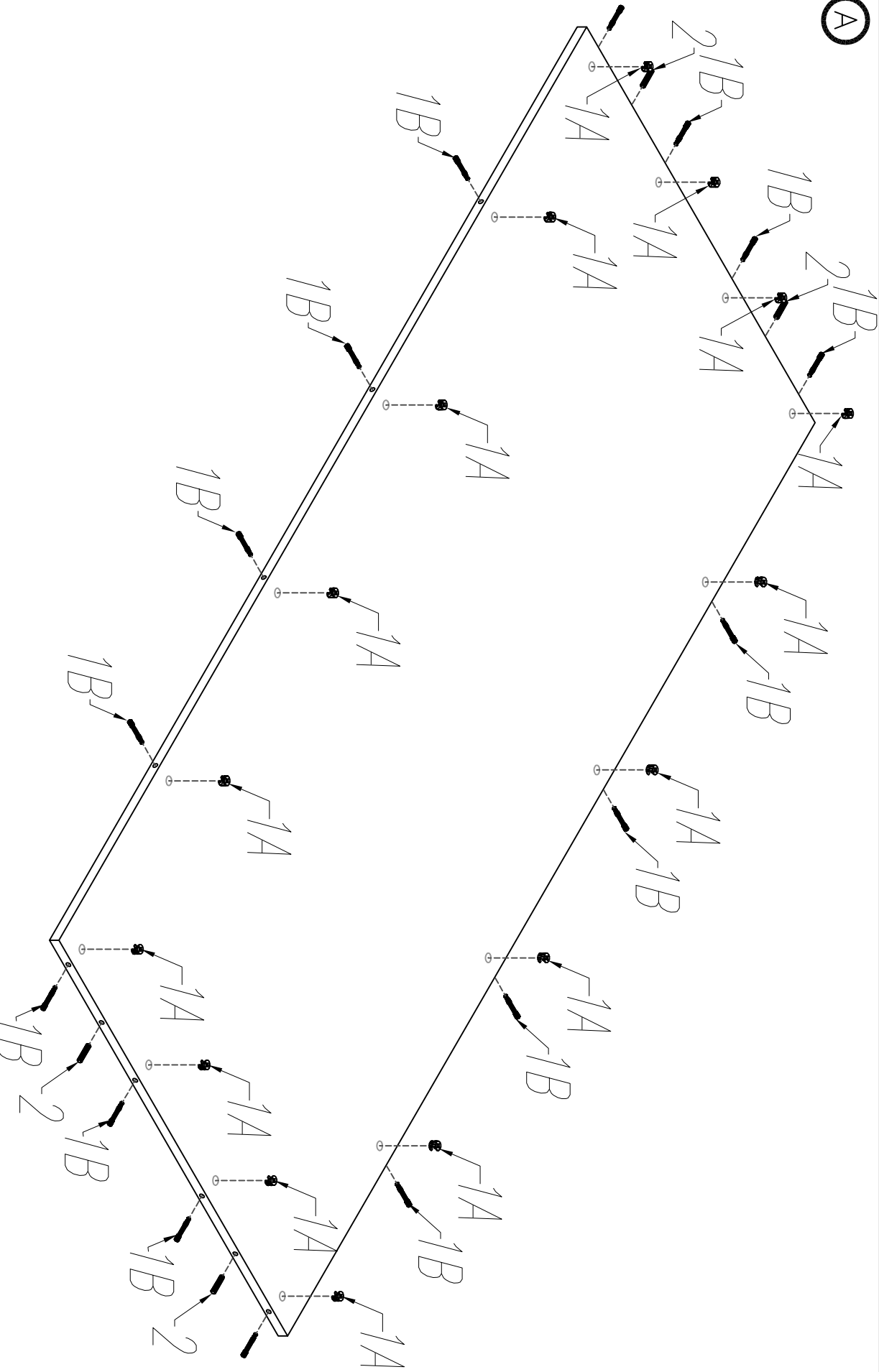

**MIT19**  
**MIT21**

KOLEJNOŚĆ MONTAŻU  
MONTAZOVÝ SEQUENC  
THE FITTINGS SEQUENCE OF THE  
CAMS AND DOWELS.  
DIE MONTAGEFOLGE VON  
EXZENTERN UND DÜBELN.

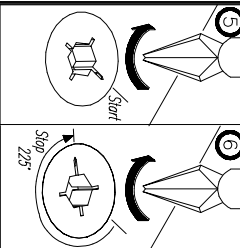
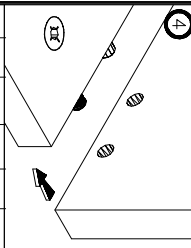
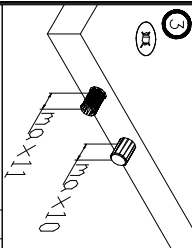
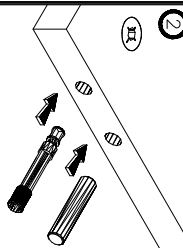
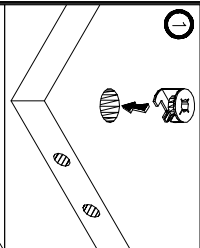

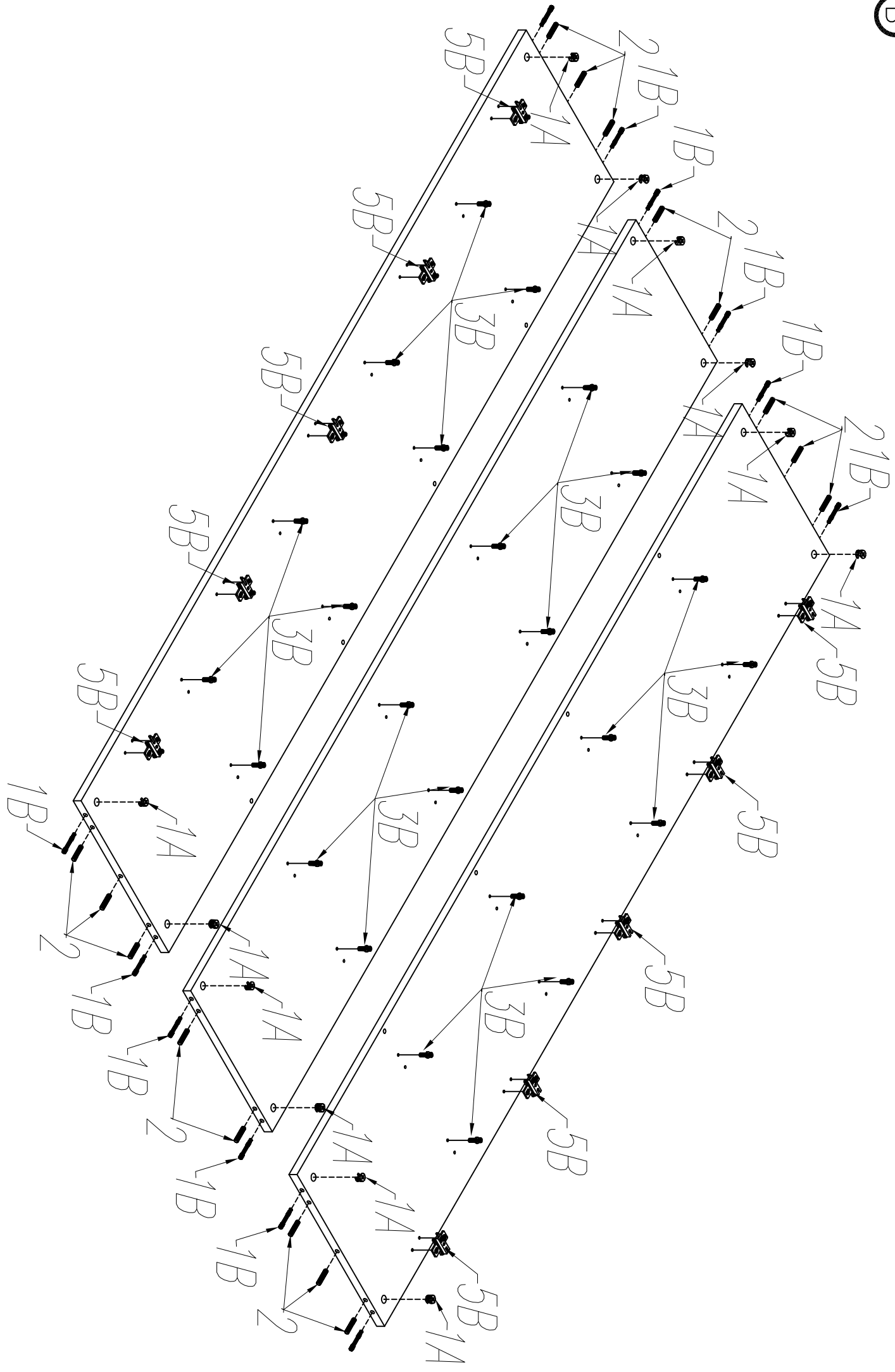

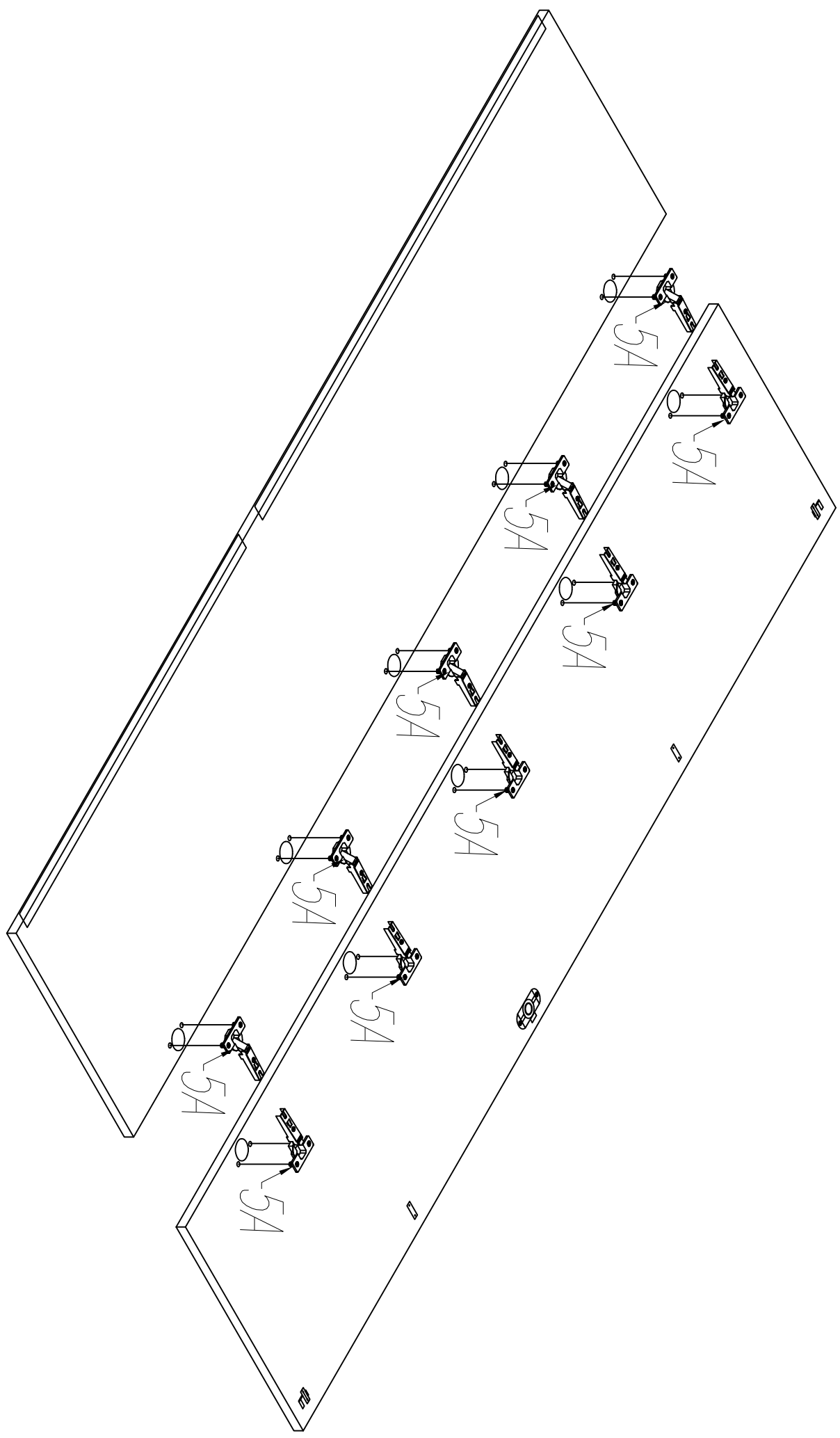

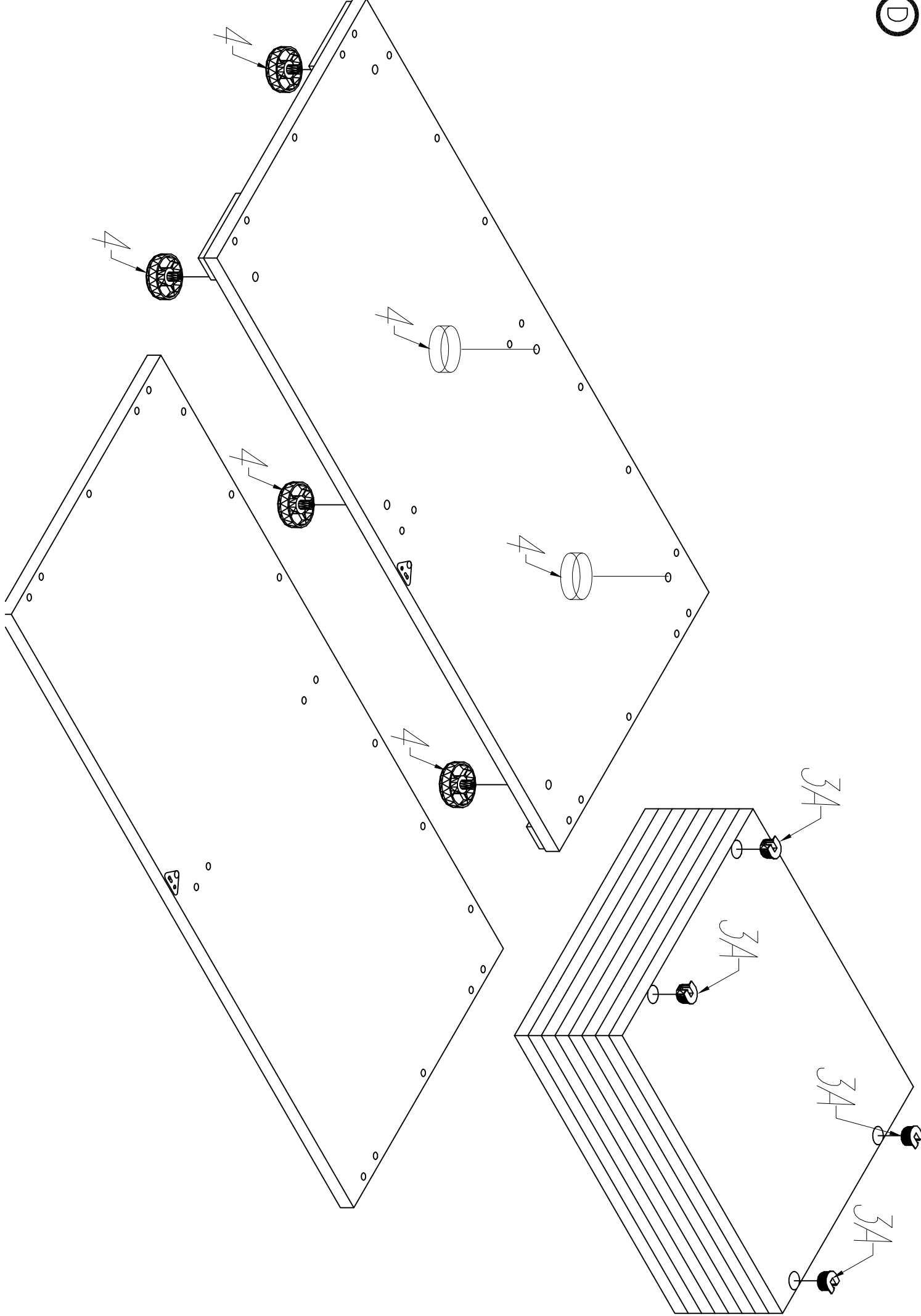

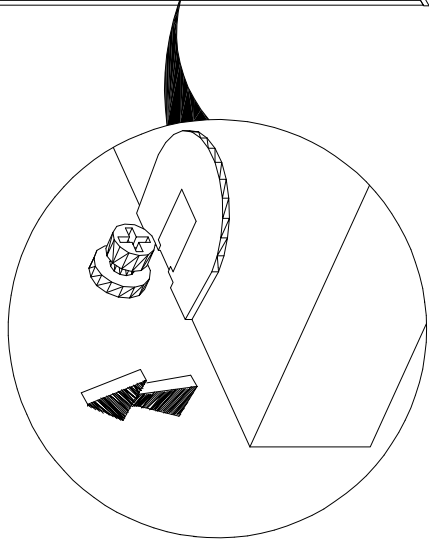
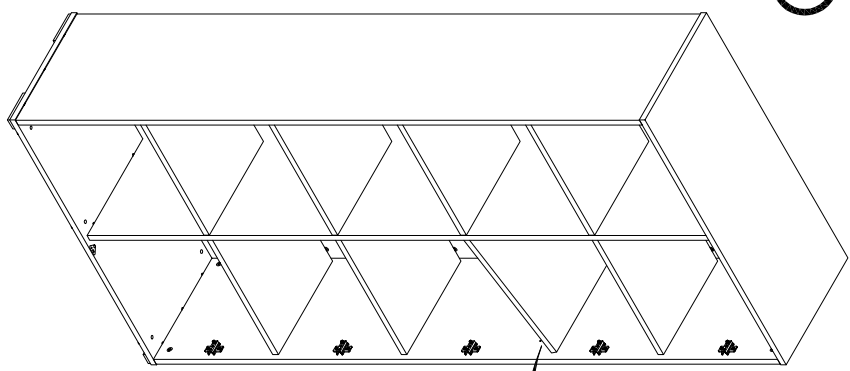
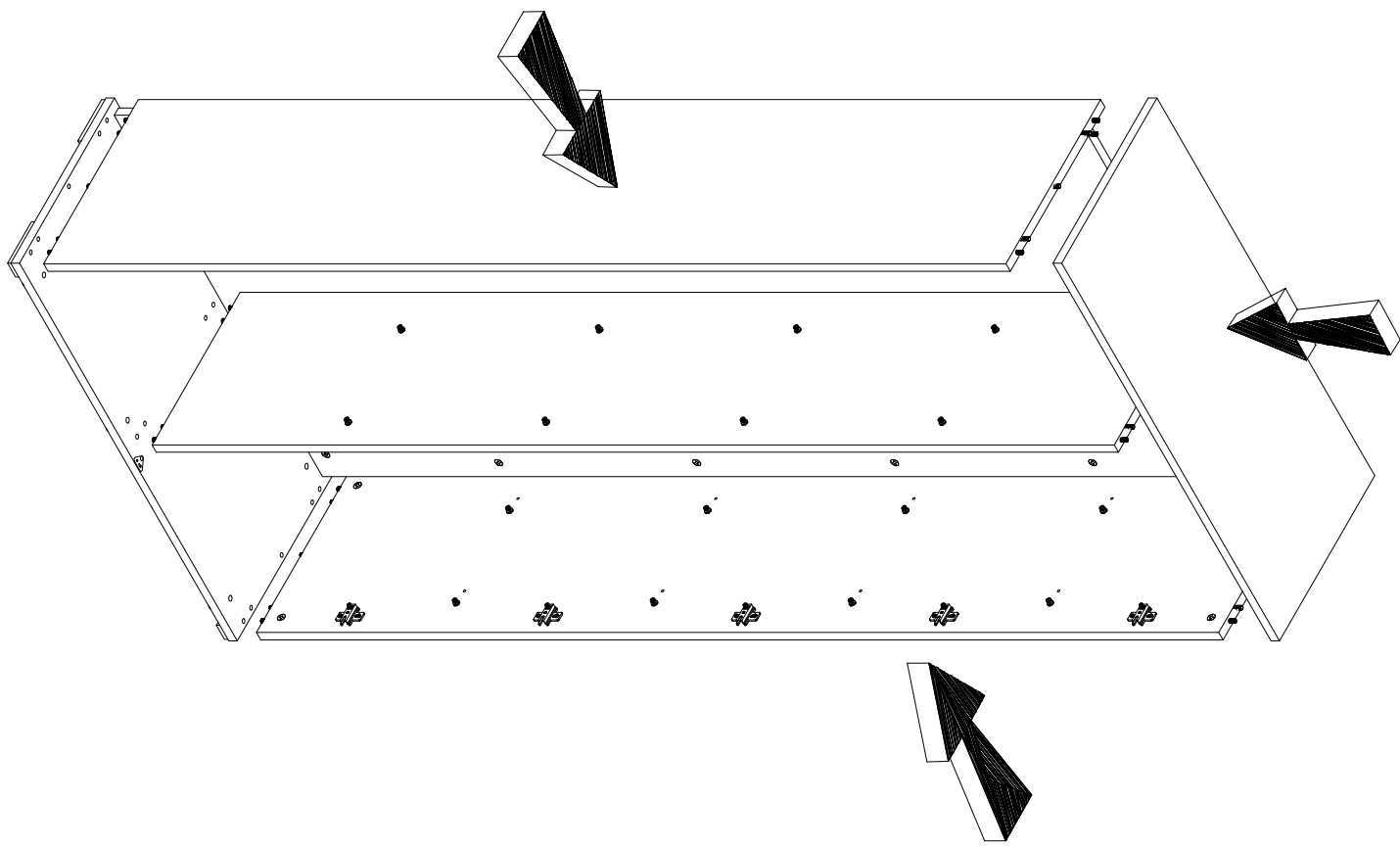

**MIT19**

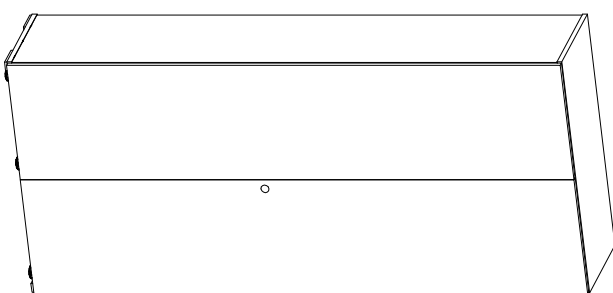

**MIT21**

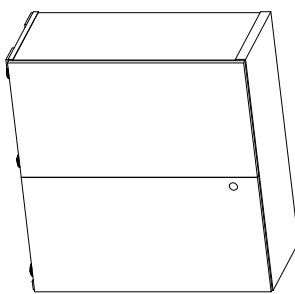

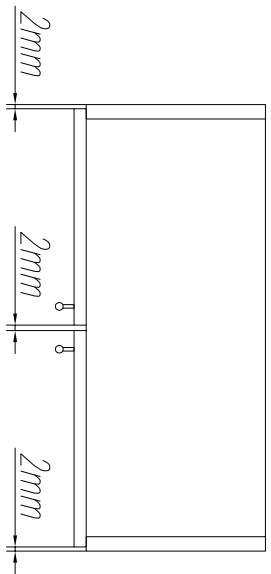
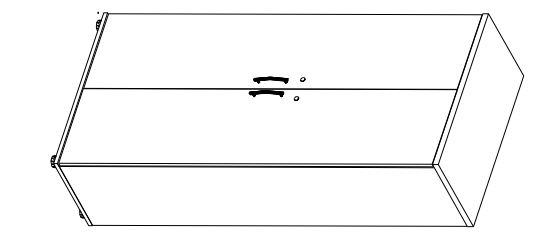
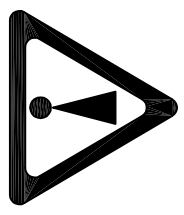
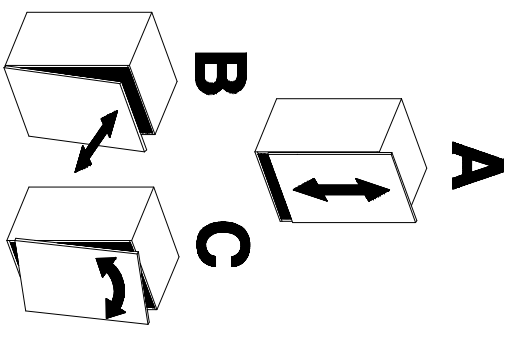
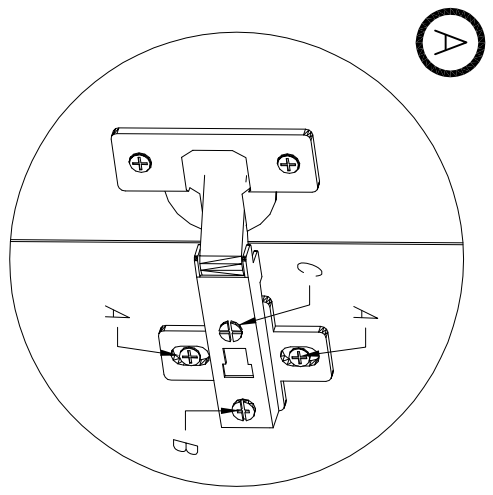
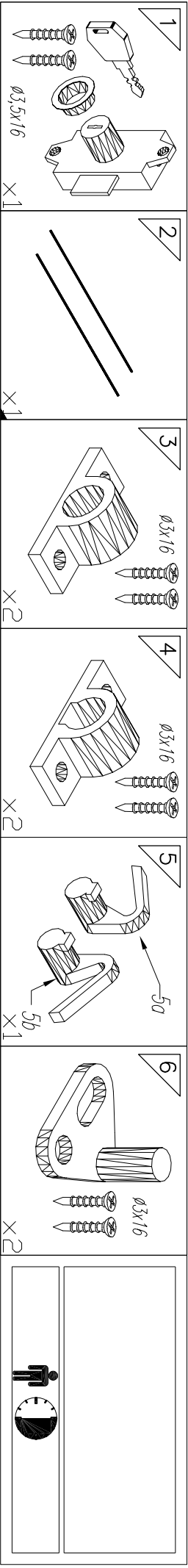

**B**

