

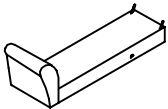

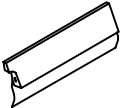

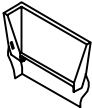



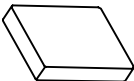

Legs & hardware are stored at the bottom of sofa, please take out the legs and hardware for assembly.

Note: Do not use power tools for assembly. Power tools increase the risk of over tightening which lead to splitting or cracking the wood.

Component list

No	Drawing	Qty	Description
A		1	LSF SOFA BASE
B		1	BACK
C		1	CORNER BACK
D		4	PLASTIC LEGS (6*6*2.75")
E		8	SCREW (Ø4*2.25")
F		3	SEAT CUSHIONS
G		1	LFS BACK CUSHION
H		1	MIDDLE BACK CUSHION
I		1	RSF BACK CUSHION
J		1	CORNER BACK CUSHION
K		4	PILLOW (21"X21")

Step #1

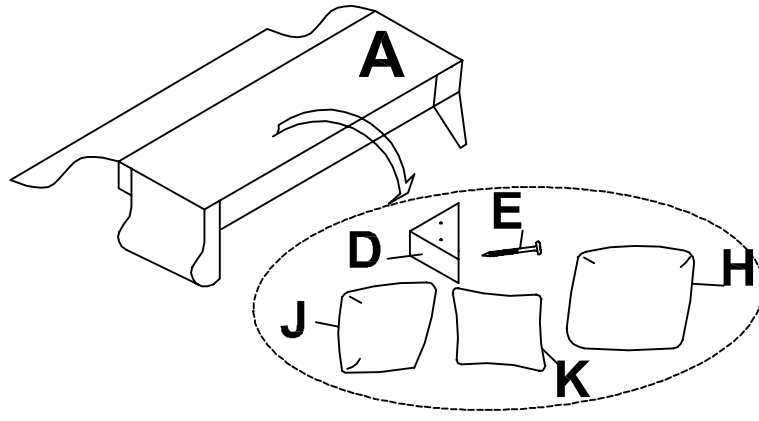

Step #2

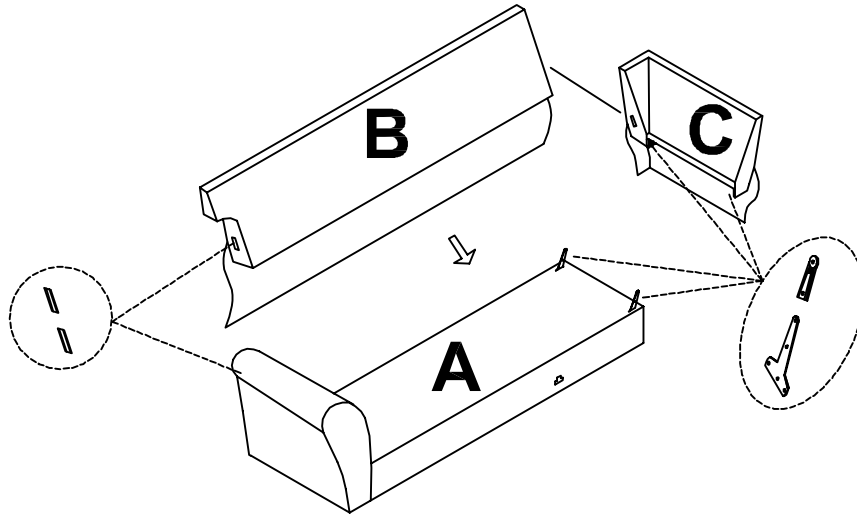

Step #3

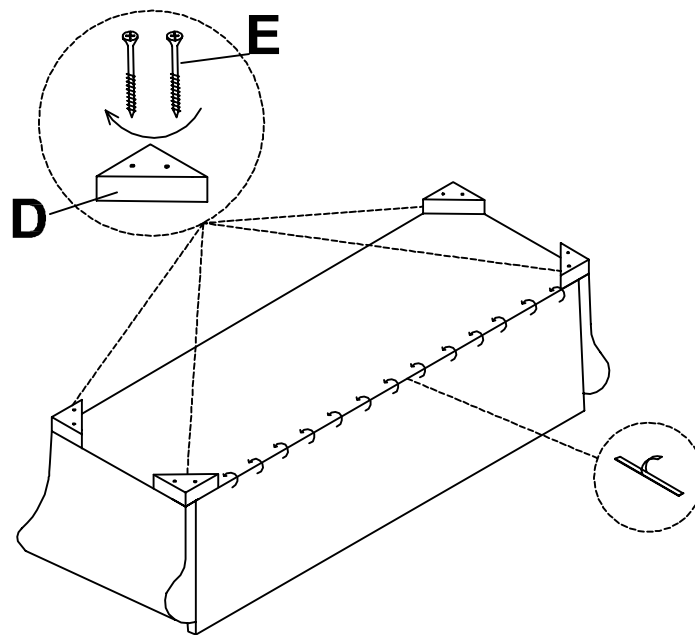

Step #4

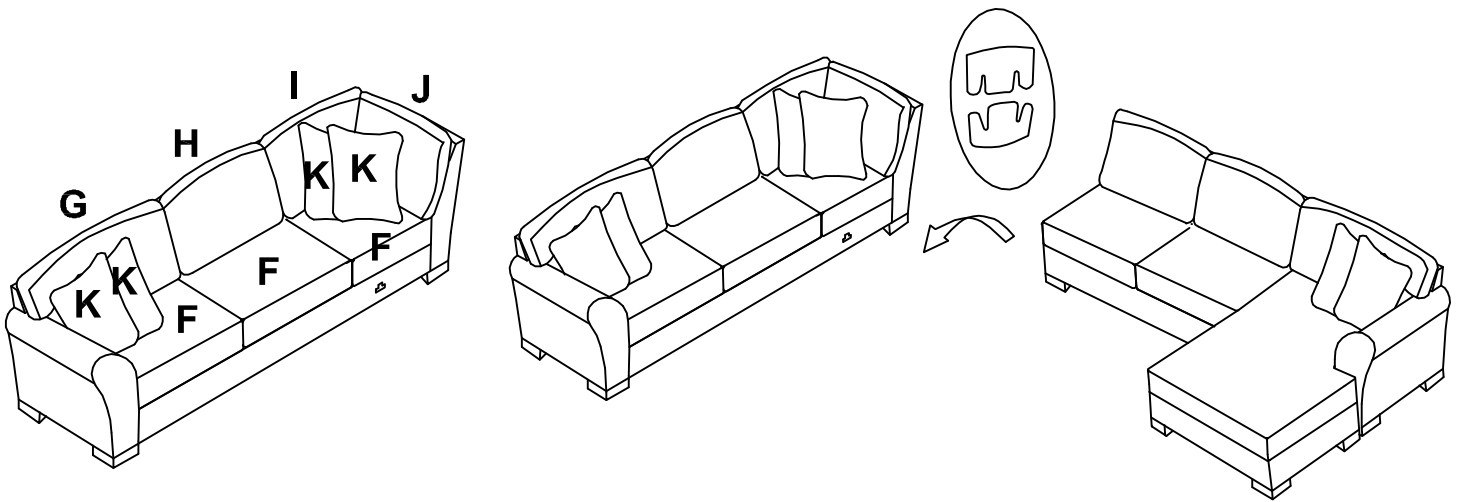

ALL IN 1 SET

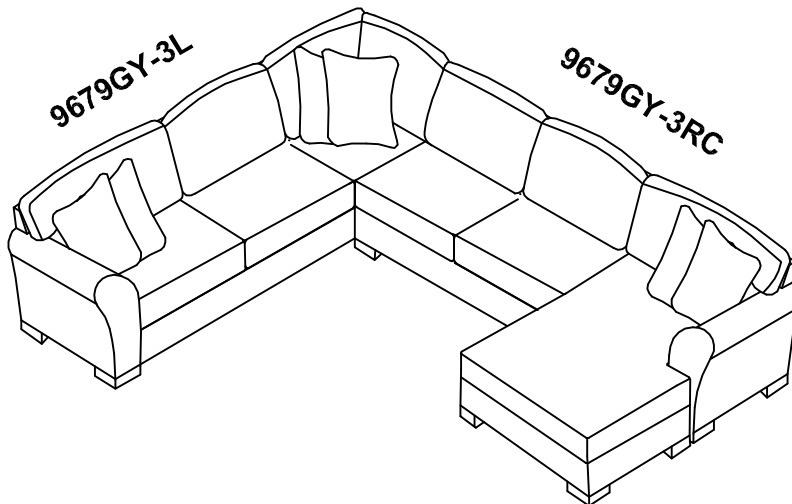

Care Instruction for Chenille Furniture:

In order to maintain the original appearance of your Chenille Furniture please follow below simple care procedures:

- Avoid exposing furniture directly to sunlight or heating and air conditioning outlets. Sunlight and or exposure to heating and air conditioning outlets will fade/damage Chenille
- Vacuum or wipe with a soft cloth to remove dust.
- Hardware may loosen over time. Periodically check to make sure all connection are tight, Re-tighten if necessary









For items use on wooden floor, hard surfaces or carpets, it is recommended to Install protective pads under all legs and supports to avoid/prevent from damages/scratches and discoloration.

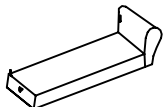
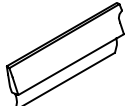
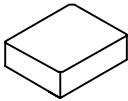

Legs & hardware are stored at the bottom of sofa, please take out the legs and hardware for assembly.

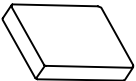
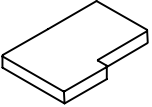
Note: Do not use power tools for assembly. Power tools increase the risk of over tightening which lead to splitting or cracking the wood.

Component list

No	Drawing	Qty	Description
A		1	RSF SOFA BASE
B		1	BACK
C		1	OTTOMAN BASE
D		8	PLASTIC LEGS (6*6*2.75")
E		16	SCREW (Ø4*2.25")
F		2	SEAT CUSHIONS
G		1	RSF SEAT CUSHION
H		1	RSF BACK CUSHION
I		2	BACK CUSHIONS
J		2	PILLOW (21"X21")

Step #1

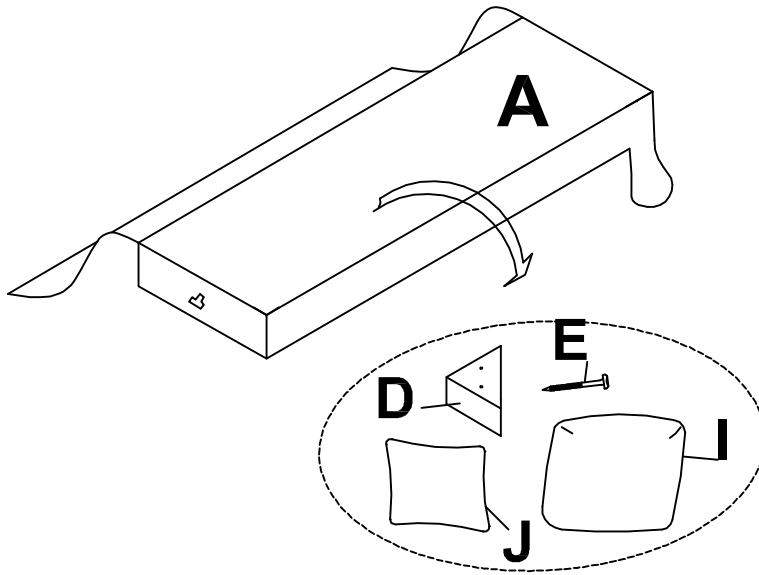

Step #2

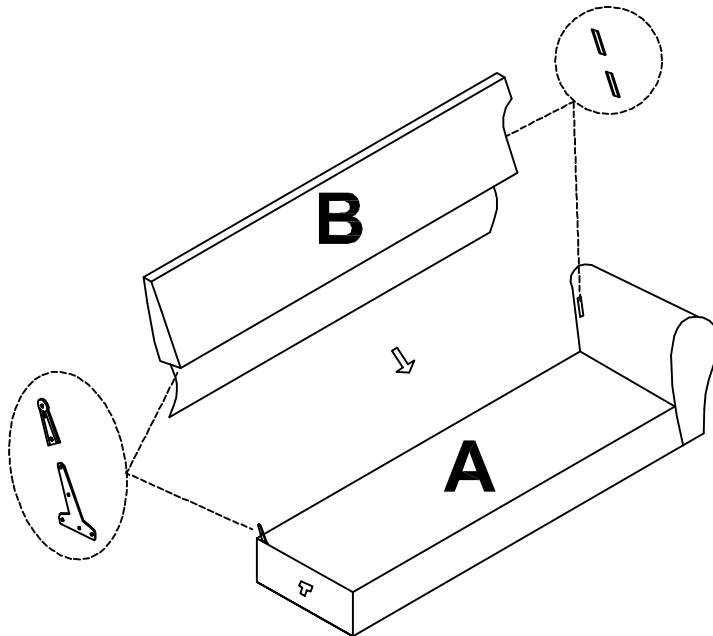

Step #3

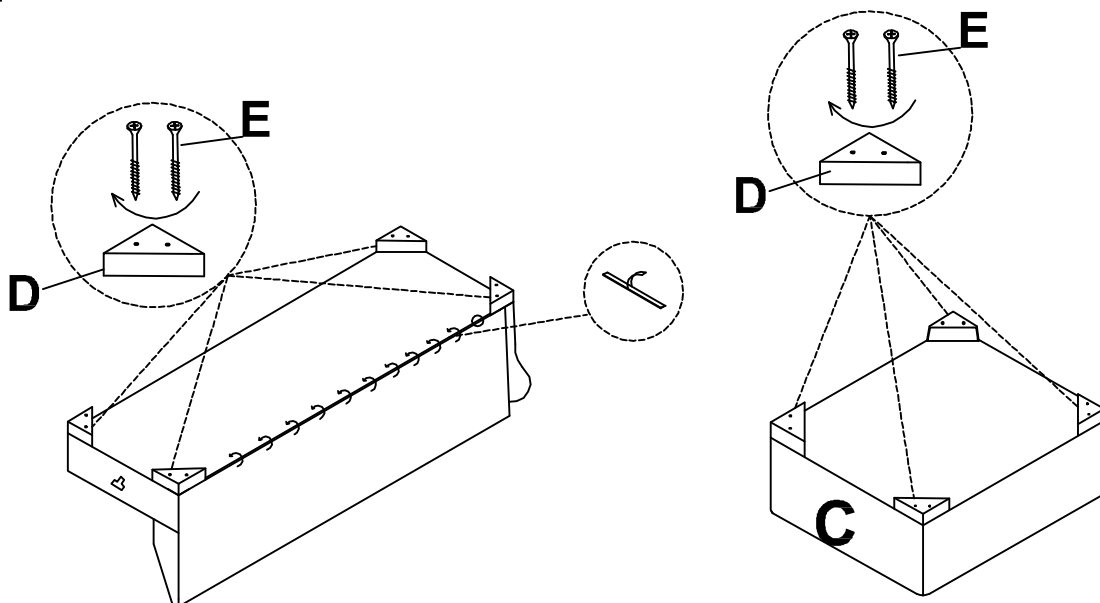

Step #4

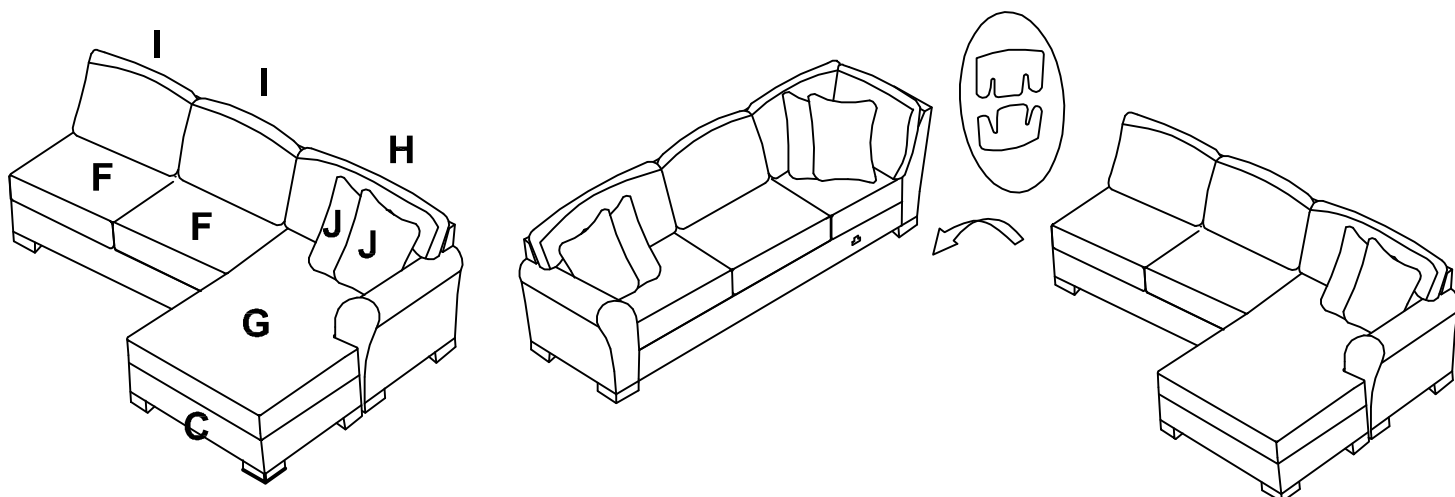

ALL IN 1 SET

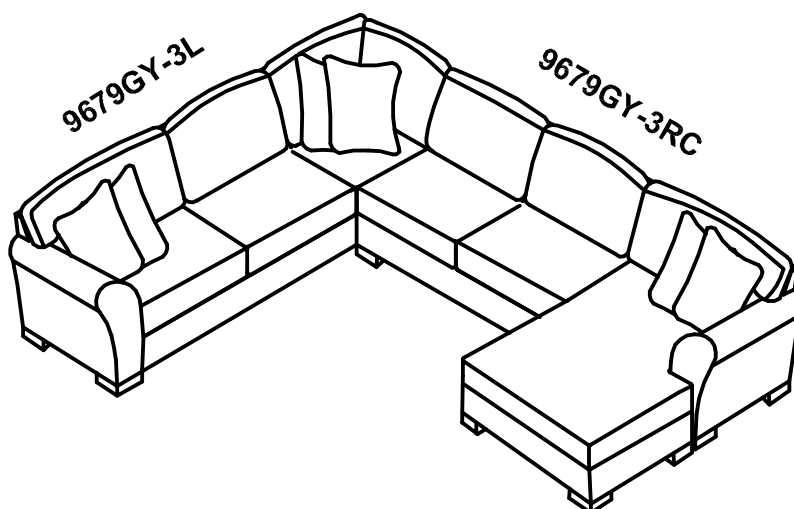

Care Instruction for Chenille Furniture:

In order to maintain the original appearance of your Chenille Furniture please follow below simple care procedures:

- Avoid exposing furniture directly to sunlight or heating and air conditioning outlets. Sunlight and or exposure to heating and air conditioning outlets will fade/damage Chenille
- Vacuum or wipe with a soft cloth to remove dust.
- Hardware may loosen over time. Periodically check to make sure all connection are tight, Re-tighten if necessary



For items use on wooden floor, hard surfaces or carpets, it is recommended to Install protective pads under all legs and supports to avoid/prevent from damages/scratches and discoloration.