

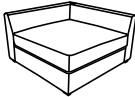



# ASSEMBLY INSTRUCTION

ITEM NO: 9535PT-CR CORNER SEAT

NO.	PARTS LIST	QTY	DESCRIPTION
A		1	Seat Frame
B		1	LSF Back Cushion
C		1	RSF Back Cushion
D		2	21"x21" Toss pillow

**STEP 1:** Take out Toss pillow(D) the zippered pocket.

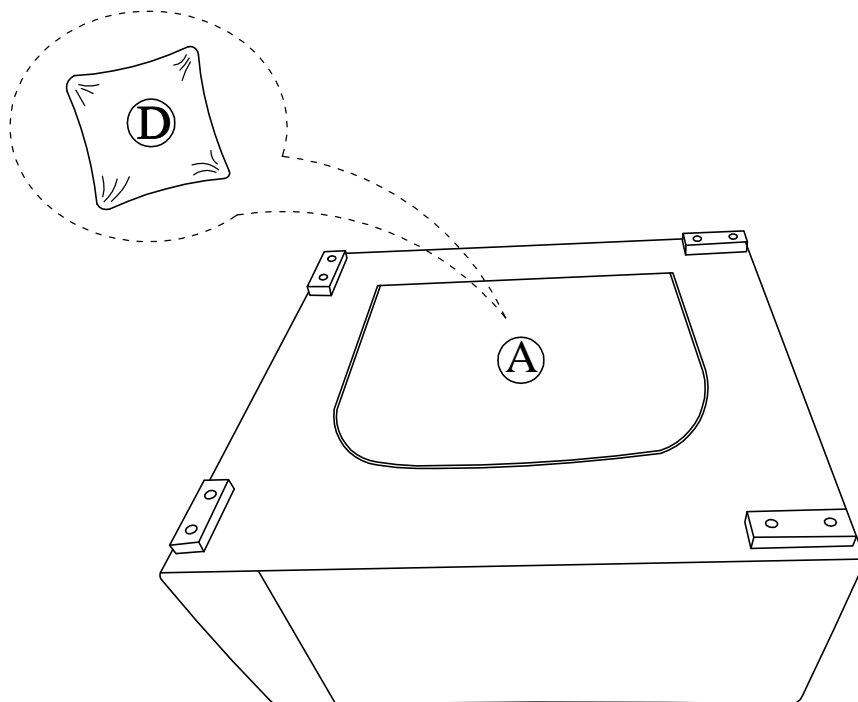

# ASSEMBLY INSTRUCTION

ITEM NO: 9535PT-CR CORNER SEAT

**STEP 2:** Put LSF Back Cushion(B) and RSF Back Cushion(C) on Seat Frame(A).

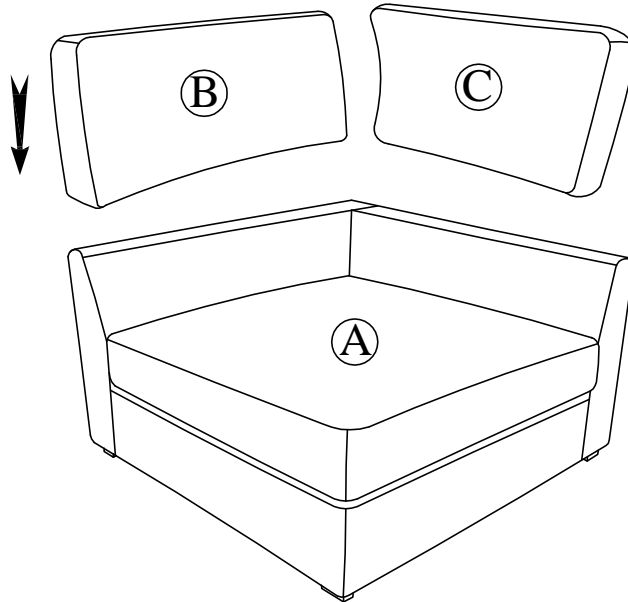

**STEP 3:** Completed

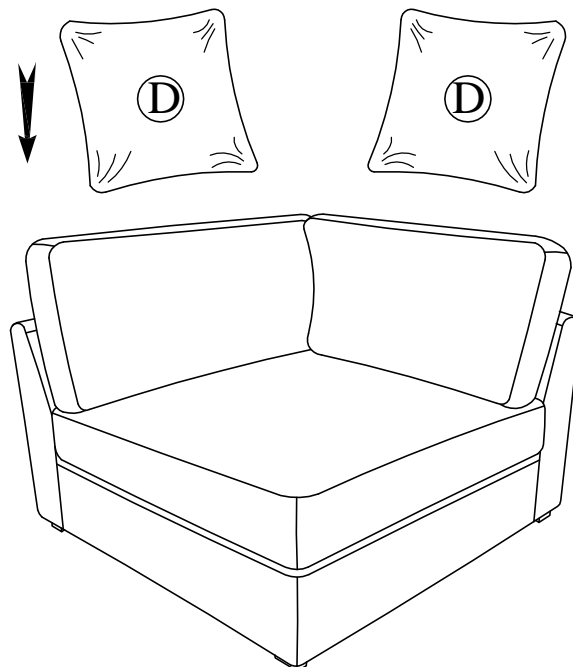

## CARE INSTRUCTION FOR FABRIC FURNITURE





In order to maintain the original appearance of your fabric furniture, please follow below simple care procedures.

°Avoid exposing furniture directly to sunlight or heating and air conditioning outlets. Exposure to sunlight or heating and air conditioning outlets will fade/damage fabric.

°Wipe gently with a damp soft cloth to remove dust, dirt and any grime build up.

# ASSEMBLY INSTRUCTION

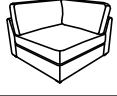
ITEM NO: 9535PT-CR CORNER SEAT

NO.	PARTS LIST	QTY	DESCRIPTION
A-1R		1	RSF CHAIR
B-AC		1	ARMLESS CHAIR
C-CR		1	CORNER SEAT
D-1L		1	LSF CHAIR

**STEP 4:** Sectional connection by placing B into piece A Continue sectional connection with piece C and D the same method.

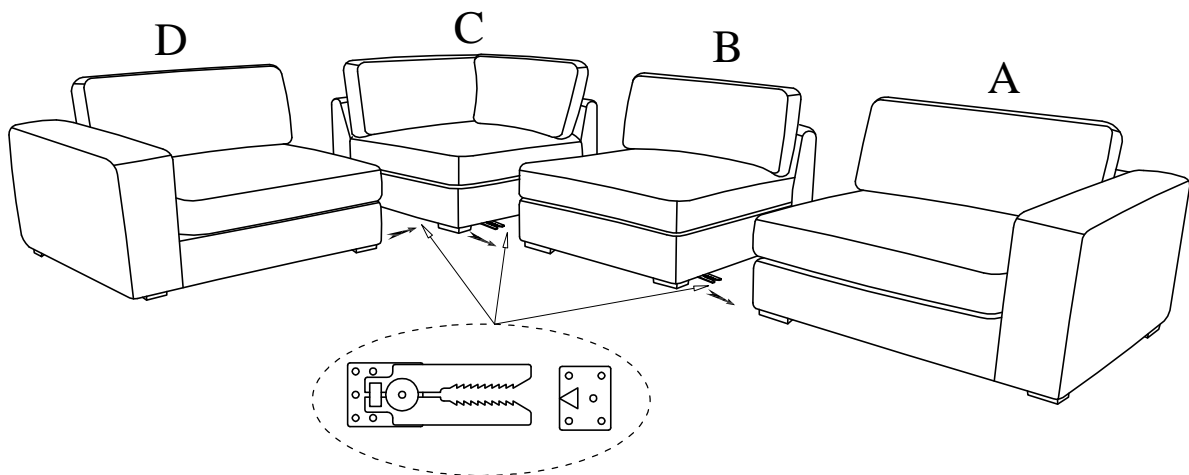



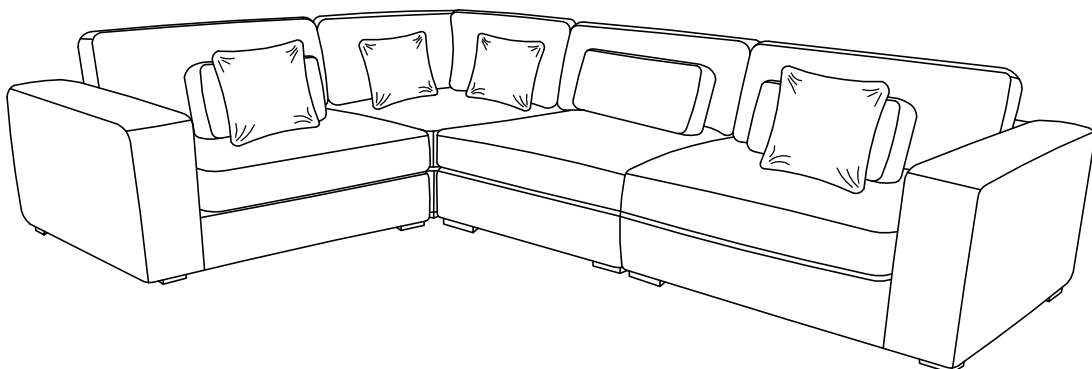

**STEP 5:** Completed

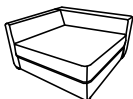

# ASSEMBLY INSTRUCTION

ITEM NO: 9535PT-1R RSF CHAIR

NO.	PARTS LIST	QTY	DESCRIPTION
A		1	Seat Frame
B		1	Back Cushion
C		1	32-1/2"x12" Kidney pillow
D		1	21"x21" Toss pillow

**STEP 1:** Take out Toss pillow(D) the zippered pocket.

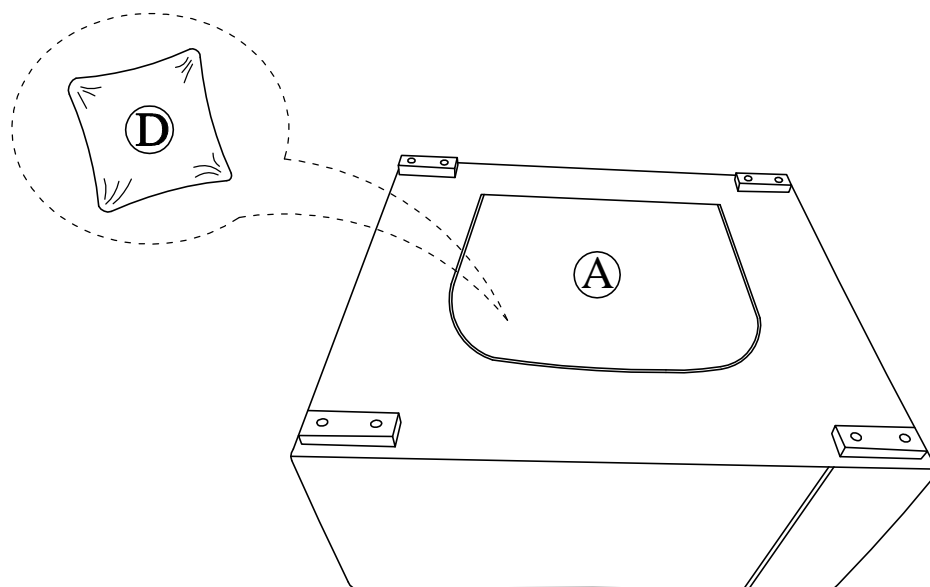

# ASSEMBLY INSTRUCTION

ITEM NO: 9535PT-1R RSF CHAIR

**STEP 2:** Put Back Cushion(B) and Kidney pillow(C) on Seat Frame(A).

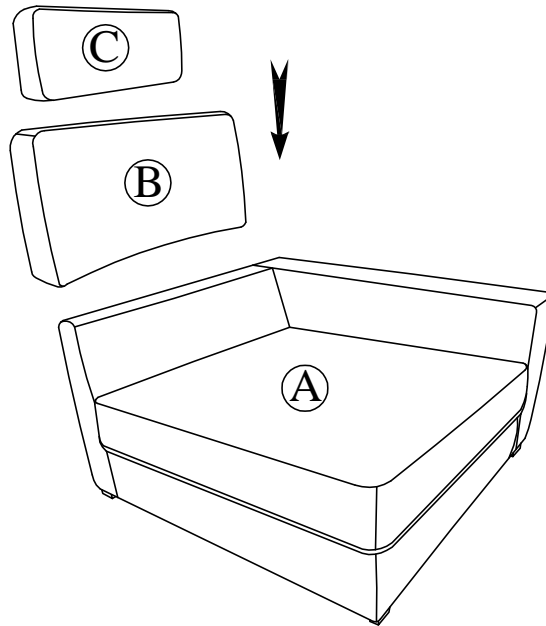

**STEP 3:** Completed

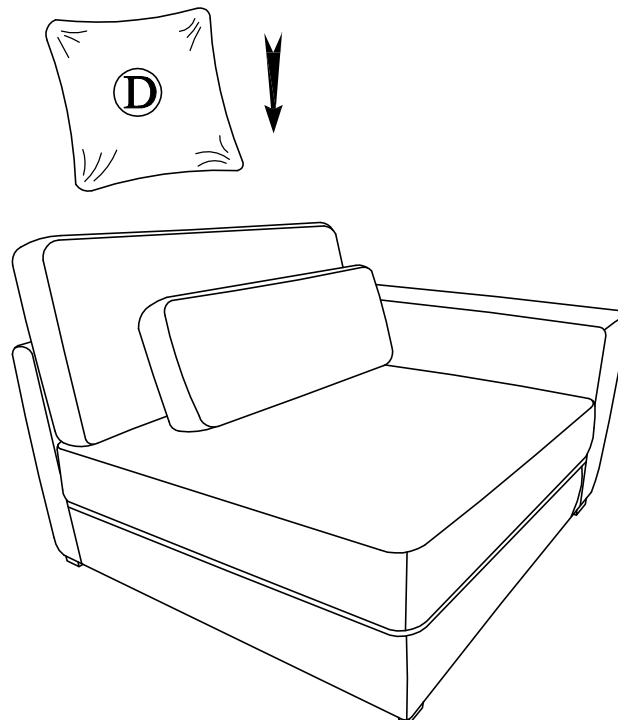

### CARE INSTRUCTION FOR FABRIC FURNITURE





In order to maintain the original appearance of your fabric furniture, please follow below simple care procedures.

°Avoid exposing furniture directly to sunlight or heating and air conditioning outlets. Exposure to sunlight or heating and air conditioning outlets will fade/damage fabric.

°Wipe gently with a damp soft cloth to remove dust, dirt and any grime build up.

# ASSEMBLY INSTRUCTION

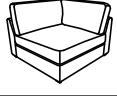
ITEM NO: 9535PT-1R RSF CHAIR

NO.	PARTS LIST	QTY	DESCRIPTION
A-1R		1	RSF CHAIR
B-AC		1	ARMLESS CHAIR
C-CR		1	CORNER SEAT
D-1L		1	LSF CHAIR

**STEP 4:** Sectional connection by placing B into piece A Continue sectional connection with piece C and D the same method.

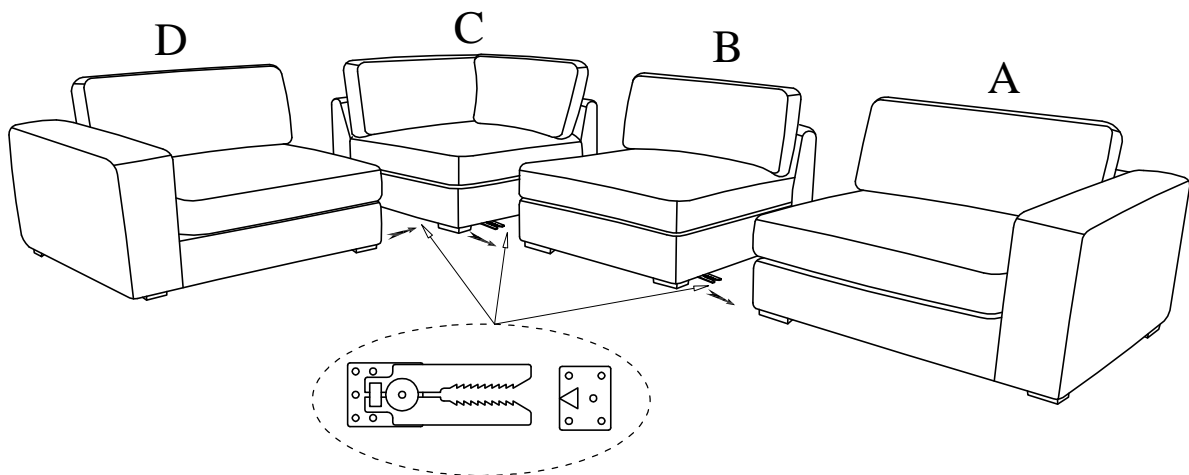



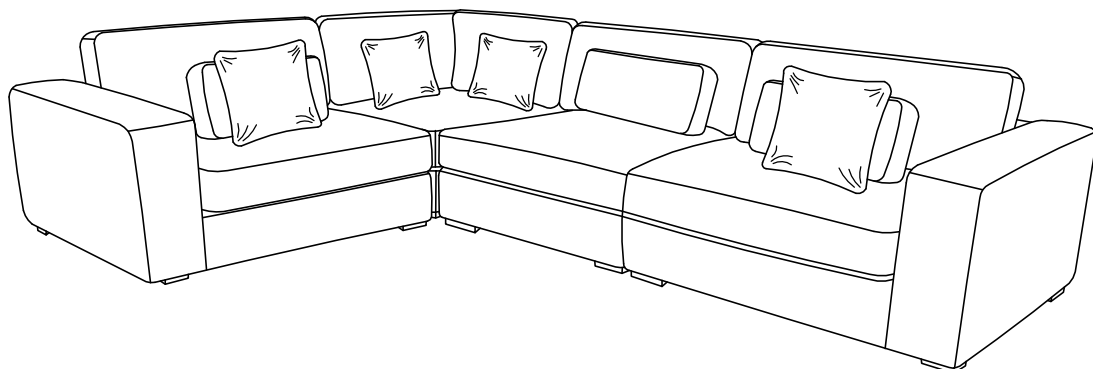

**STEP 5:** Completed

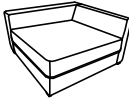

# ASSEMBLY INSTRUCTION

ITEM NO: 9535PT-1L LSF CHAIR

NO.	PARTS LIST	QTY	DESCRIPTION
A		1	Seat Frame
B		1	Back Cushion
C		1	32-1/2"x12" Kidney pillow
D		1	21"x21" Toss pillow

**STEP 1:** Take out Toss pillow(D) the zippered pocket.

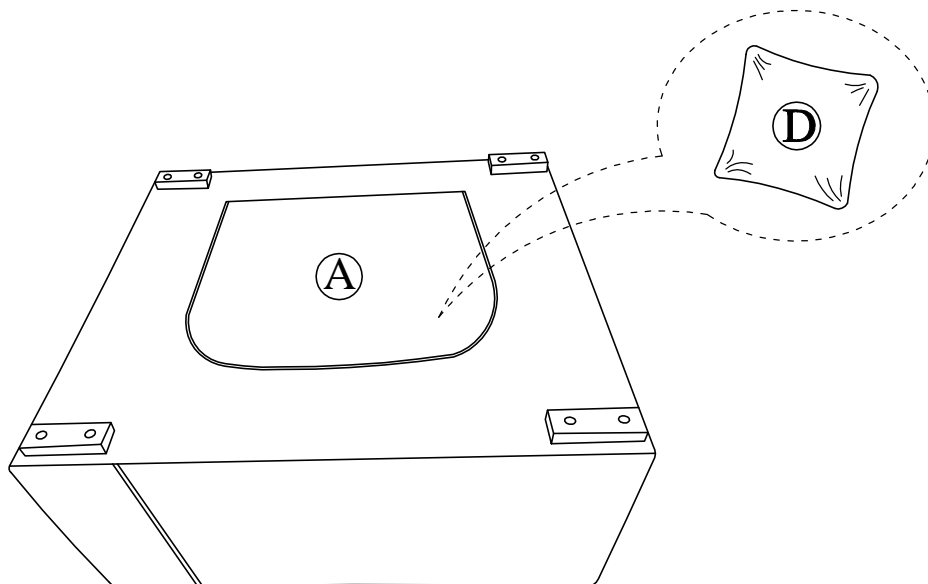

# ASSEMBLY INSTRUCTION

ITEM NO: 9535PT-1L LSF CHAIR

**STEP 2:** Put Back Cushion(B) and Kidney pillow(C) on Seat Frame(A).

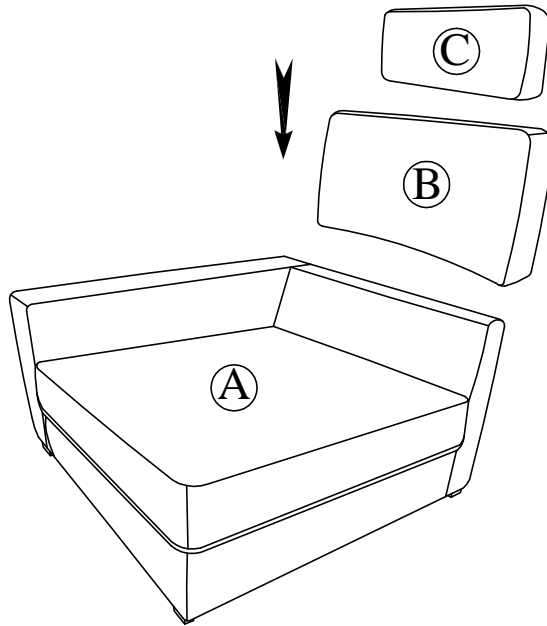

**STEP 3:** Completed

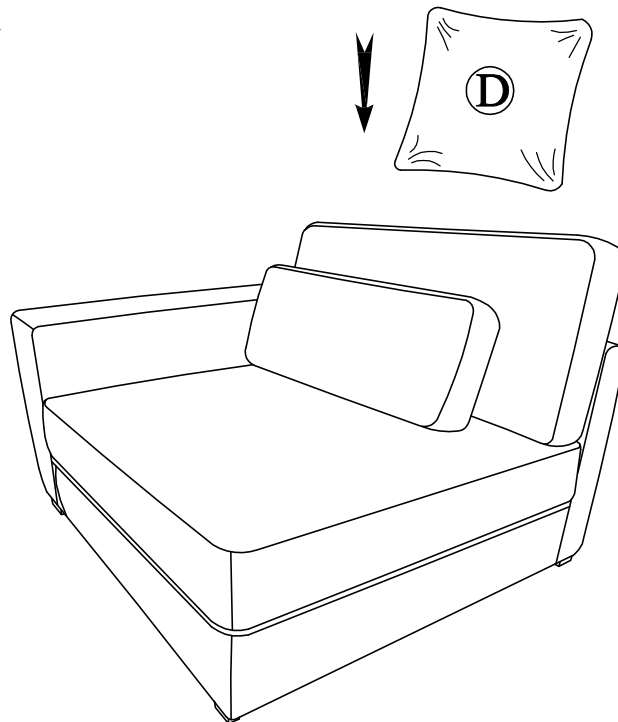

## CARE INSTRUCTION FOR FABRIC FURNITURE





In order to maintain the original appearance of your fabric furniture, please follow below simple care procedures.

°Avoid exposing furniture directly to sunlight or heating and air conditioning outlets. Exposure to sunlight or heating and air conditioning outlets will fade/damage fabric.

°Wipe gently with a damp soft cloth to remove dust, dirt and any grime build up.

# ASSEMBLY INSTRUCTION

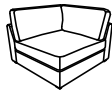
ITEM NO: 9535PT-1L LSF CHAIR

NO.	PARTS LIST	QTY	DESCRIPTION
A-1R		1	RSF CHAIR
B-AC		1	ARMLESS CHAIR
C-CR		1	CORNER SEAT
D-1L		1	LSF CHAIR

**STEP 4:** Sectional connection by placing B into piece A Continue sectional connection with piece C and D the same method.

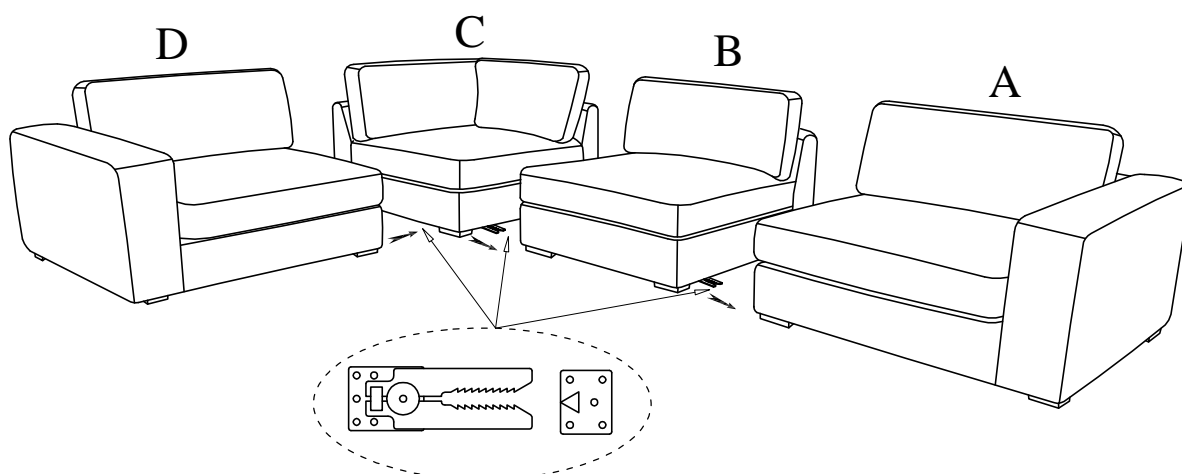

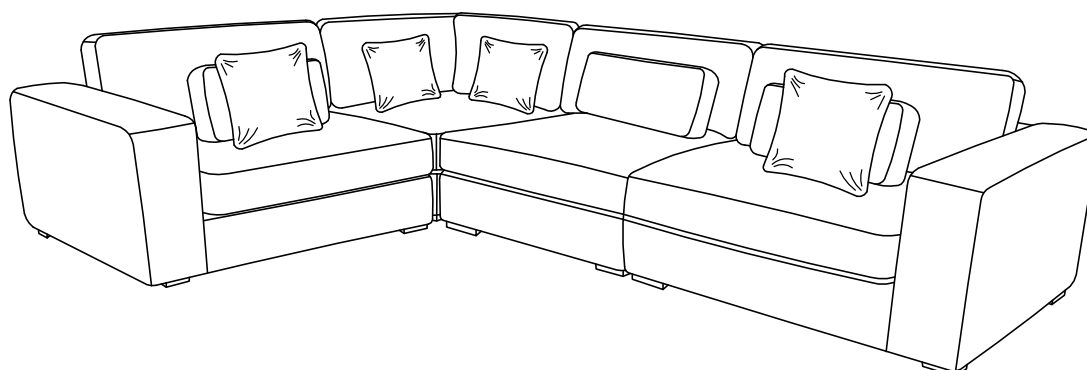

**STEP 5:** Completed



# ASSEMBLY INSTRUCTION

ITEM NO: 9535PT-AC ARMLESS CHAIR

NO.	PARTS LIST	QTY	DESCRIPTION
A		1	Seat Frame
B		1	Back Cushion
C		1	32-1/2"x12" Kidney pillow

**STEP 1:** Put Back Cushion(B) and Kidney pillow(C) on Seat Frame(A).

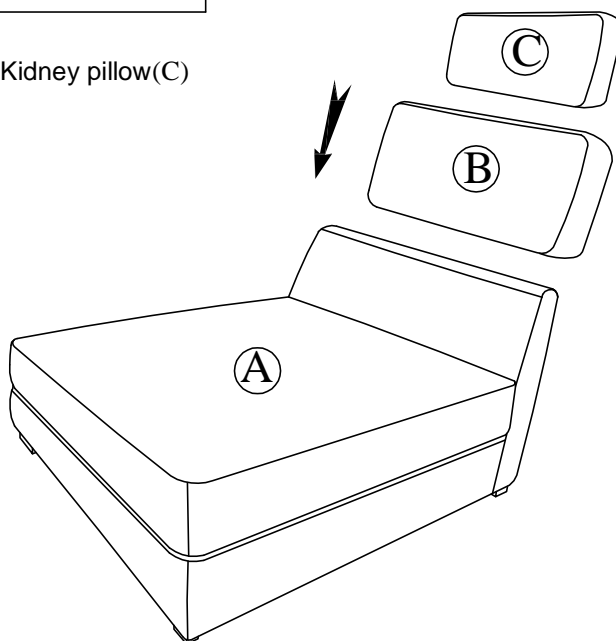

**STEP 2:** Completed

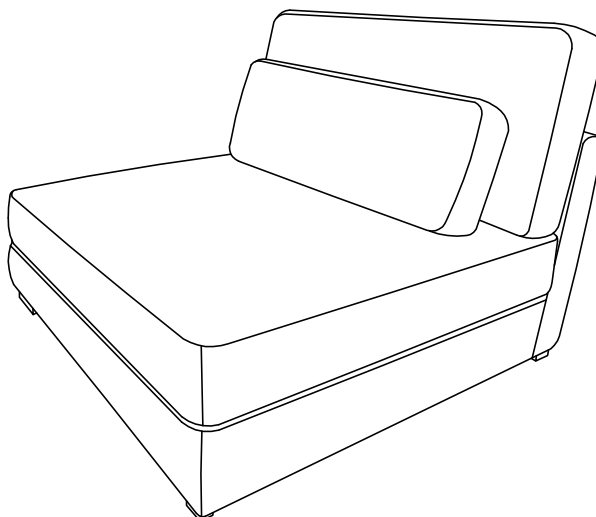

### CARE INSTRUCTION FOR FABRIC FURNITURE





In order to maintain the original appearance of your fabric furniture, please follow below simple care procedures.

°Avoid exposing furniture directly to sunlight or heating and air conditioning outlets. Exposure to sunlight or heating and air conditioning outlets will fade/damage fabric.

°Wipe gently with a damp soft cloth to remove dust, dirt and any grime build up.

# ASSEMBLY INSTRUCTION

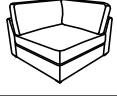
ITEM NO: 9535PT-AC ARMLESS CHAIR

NO.	PARTS LIST	QTY	DESCRIPTION
A-1R		1	RSF CHAIR
B-AC		1	ARMLESS CHAIR
C-CR		1	CORNER SEAT
D-1L		1	LSF CHAIR

**STEP 3:** Sectional connection by placing B into piece A Continue sectional connection with piece C and D the same method.

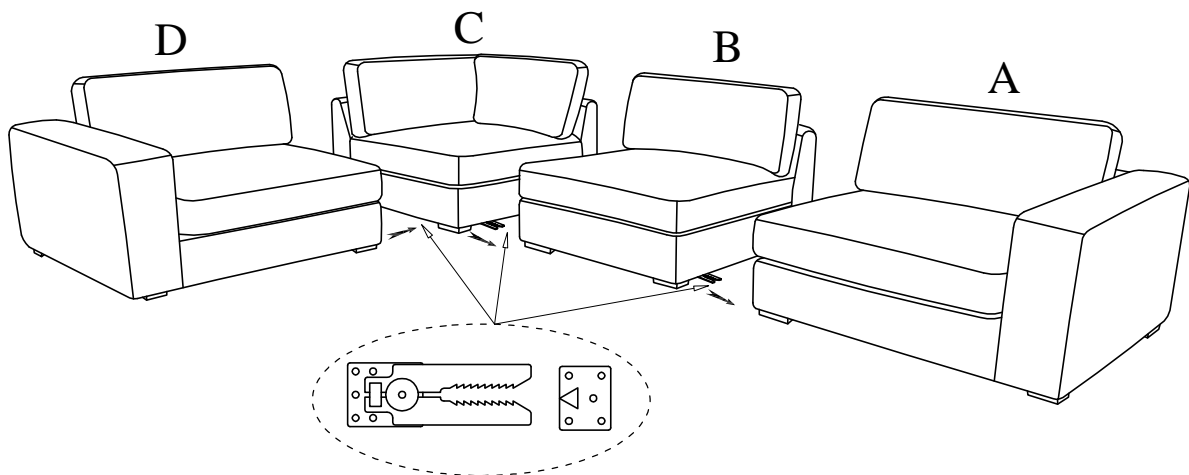

**STEP 4:** Completed

