

ASSEMBLY INSTRUCTION

ITEM NO.:8457BEG/BLK/GRY-2PW









Power Double Reclining Love Seat with Center Console,
Wireless Speakers, LED and Charging Ports

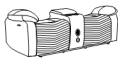

Hardware are stored in box,
please take out for assembly.

NOTE: Do not use power tools for assembly. Power tools increase the risk of over tightening which lead to splitting or cracking the wood.

COMPONENT LIST

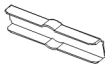
NO.	Sketch	QTY	Description	NO.	Sketch	QTY	Description
A		1 PC	Seat	E		1 PC	Left EAR
B		1 PC	Left Backrest	F		1 PC	Right EAR
C		1 PC	Right Backrest	G		1 PC	chair adaptor
D		1 PC	Console Backrest	H		1 PC	Speaker adaptor
I		2 PCS	Female bracket				

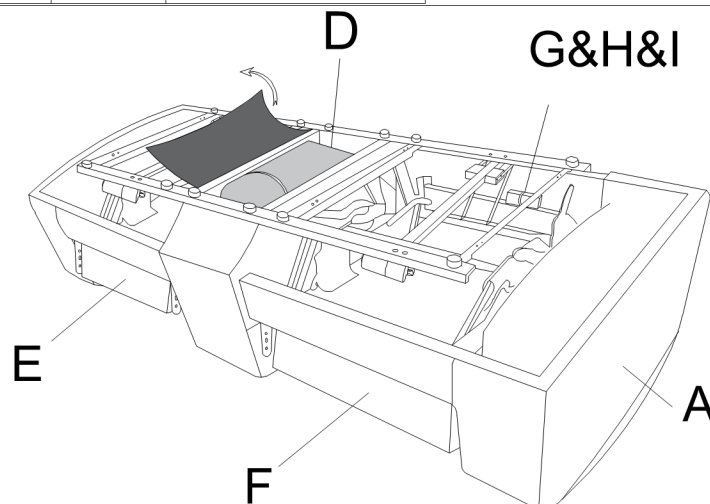

ASSEMBLY INSTRUCTION

ITEM NO.:8457BEG/BLK/GRY-2PW

Power Double Reclining Love Seat with Center Console,
Wireless Speakers, LED and Charging Ports

STEP 1:

Align metal bracket on back to the base, push to the end to secure in position.
NOTE: Console backrest(D) is packed in the bottom of base. Please take out for assembly.

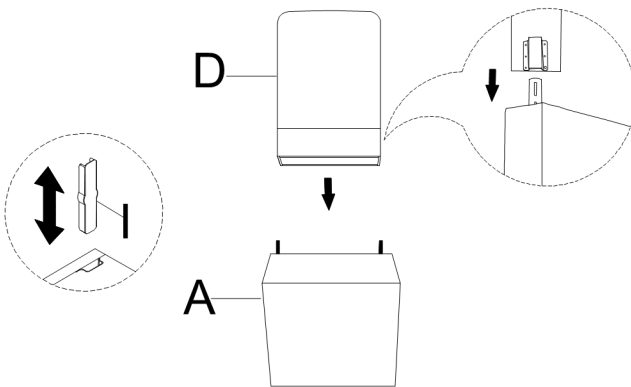

STEP 2:

Attach Left Backrest (B) and Right Backrest(C) to the Seat Body(A).

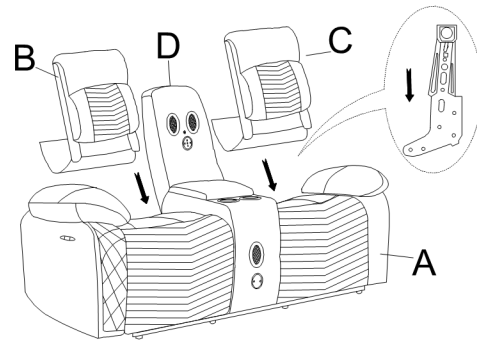

STEP 3:

Attach the Left EAR(E) and Right EAR(F) to the Backrest(B) and Backrest(C)

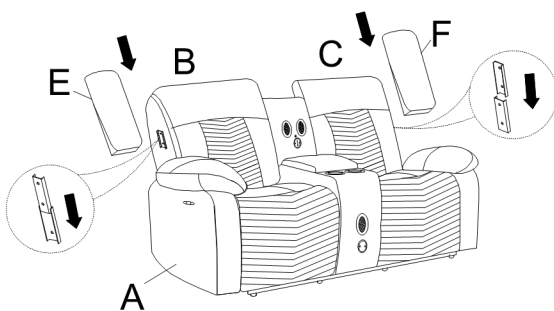

STEP 4:

Connect the power cord

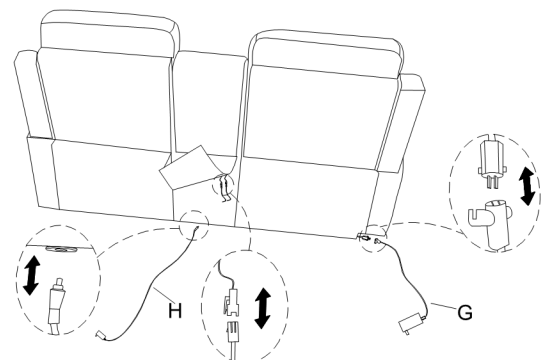

ASSEMBLY INSTRUCTION

ITEM NO.:8457BEG/BLK/GRY-2PW

Power Double Reclining Love Seat with Center Console,
Wireless Speakers, LED and Charging Ports

STEP 5:

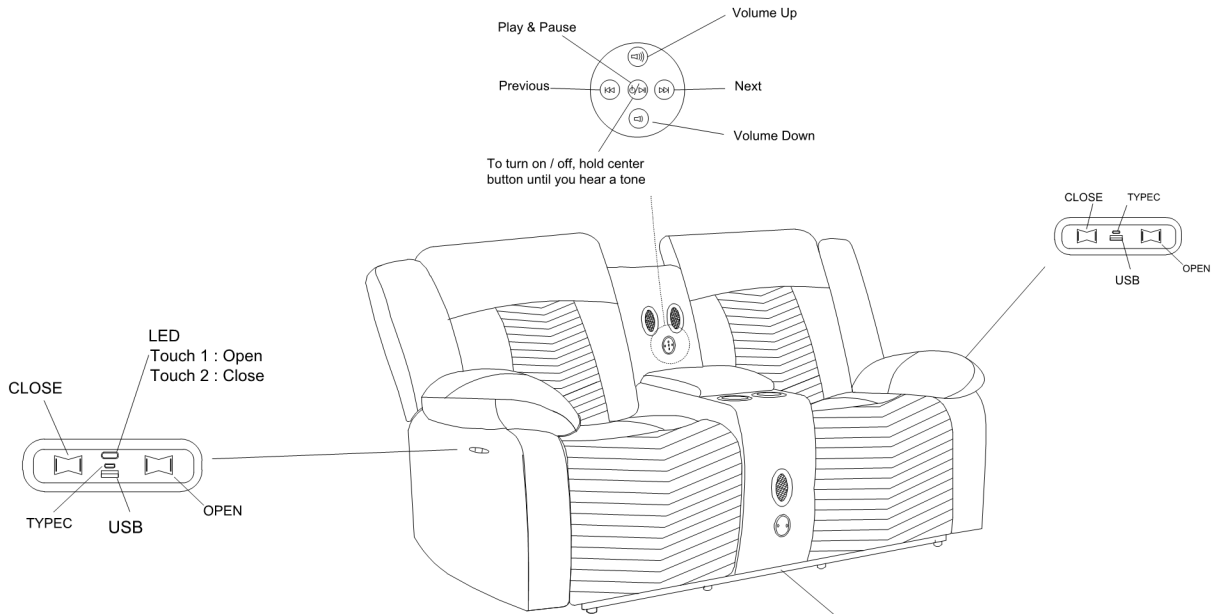

Thank you for using Remo1 Bluetooth sound system.
Before using this unit please read the instruction carefully.
This audio system is for indoor use only.
Do not attempt to modify, repair it, please contact store or customer service if you have any issue.
Trying to remove panels or repairing the unit could result electric shock, property damage and injury.
Please connect the unit directly to wall outlet, do not use extension cord.
As for how to pair Bluetooth speaker, please refer to the Instruction Manual

Led Light

STEP 6:

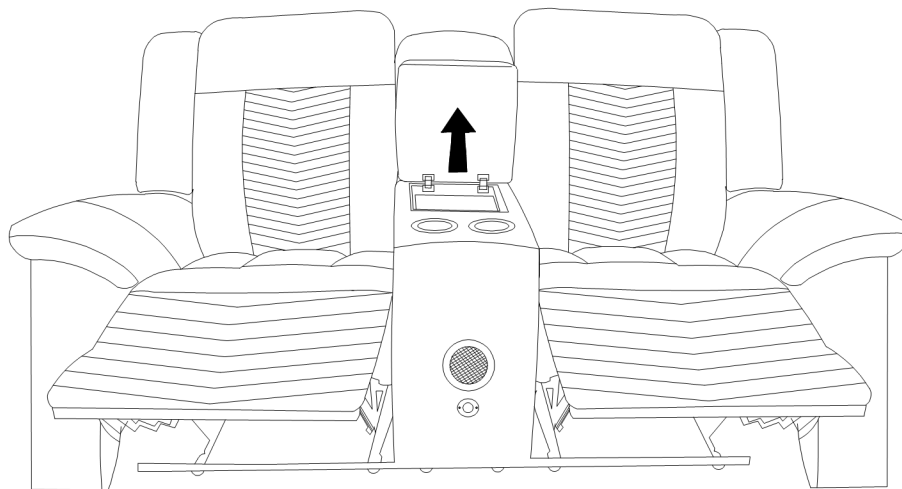

ASSEMBLY INSTRUCTION

ITEM NO.:8457BEG/BLK/GRY-2PW

Power Double Reclining Love Seat with Center Console,
Wireless Speakers, LED and Charging Ports

STEP 7:
Completed

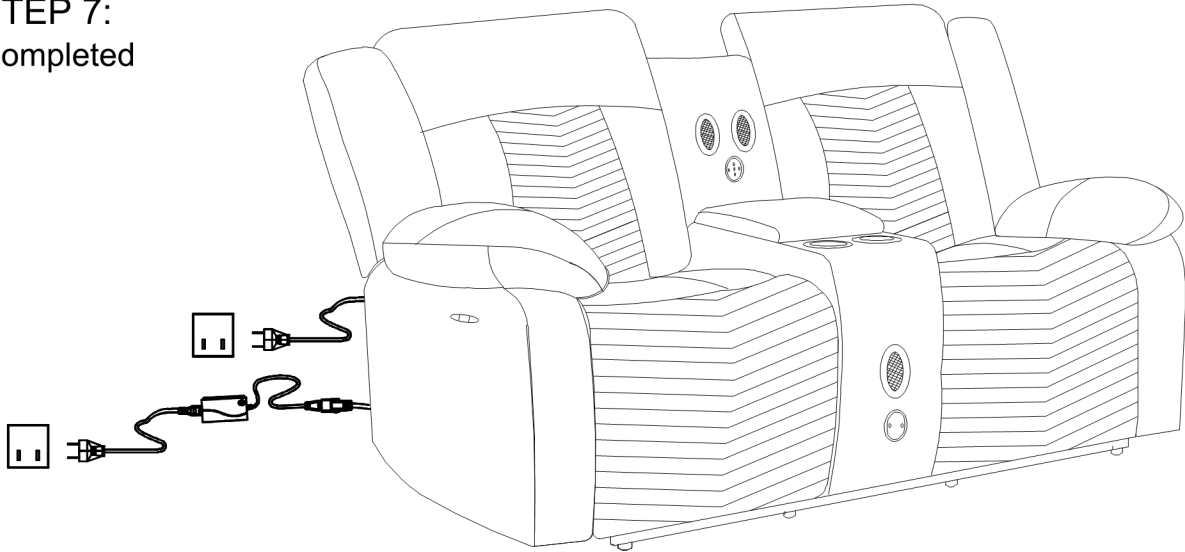

Care instruction on for PU furniture:

In order to maintain the original appearance of your PU furniture, please follow below simple care procedures:

- Avoid exposing furniture directly to sunlight or heating or heating conditioning outlets. Sunlight and or exposure to heating and air conditioning outlets will fade/damage PU.
- Do not place your upholstered furniture too close to windows, radiators
- Vacuum or wipe with a cloth regularly to remove dust.



For items used on wooden floor, hard surfaces or carpets, it is recommended to install protective pads under all legs and supports to avoid/prevent from damages/scratches and discoloration.

Warning!

Do not allow electrical cord to be pinched between moving parts or between the frame and the floor. Do not place cord under carpet or in location where it could become worn.

To avoid damage, please use scissors to remove this tag



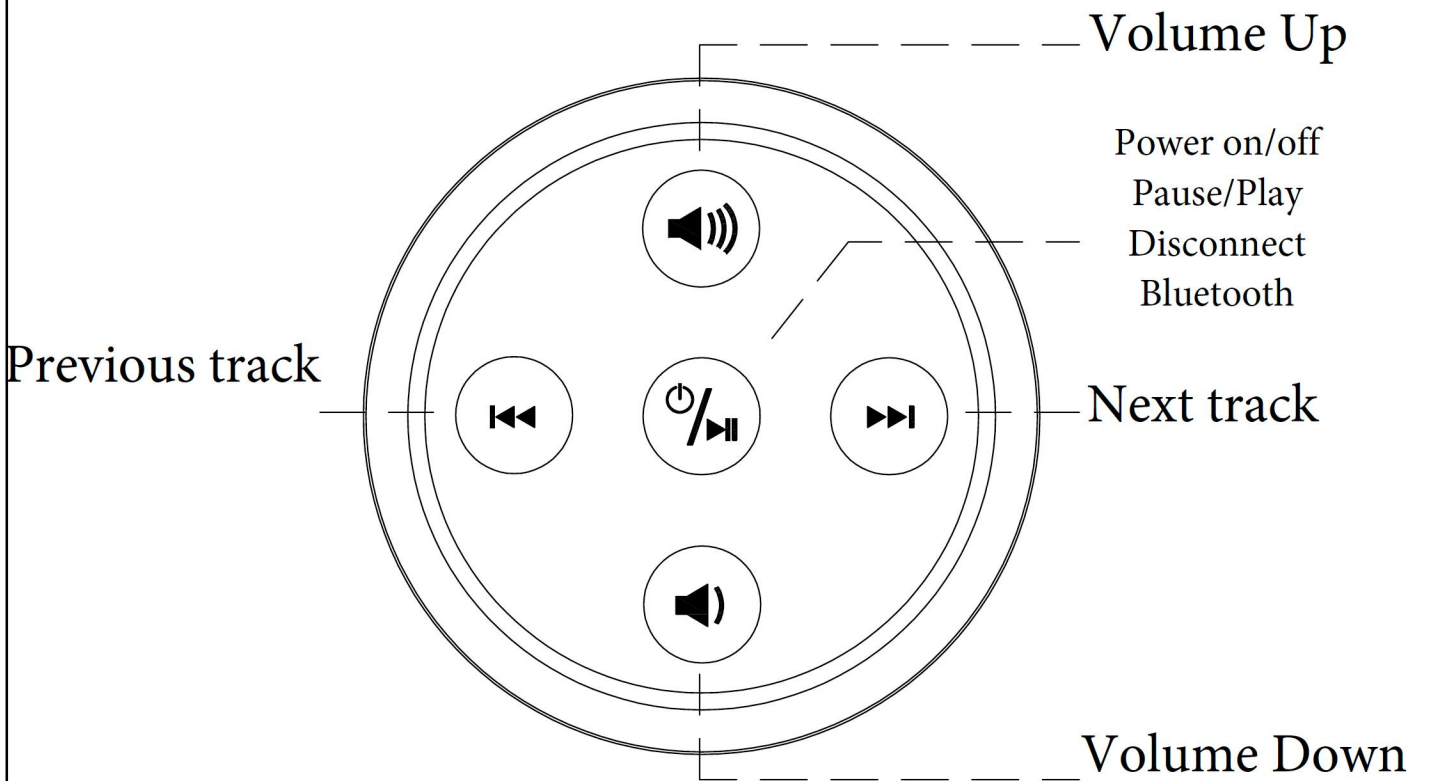
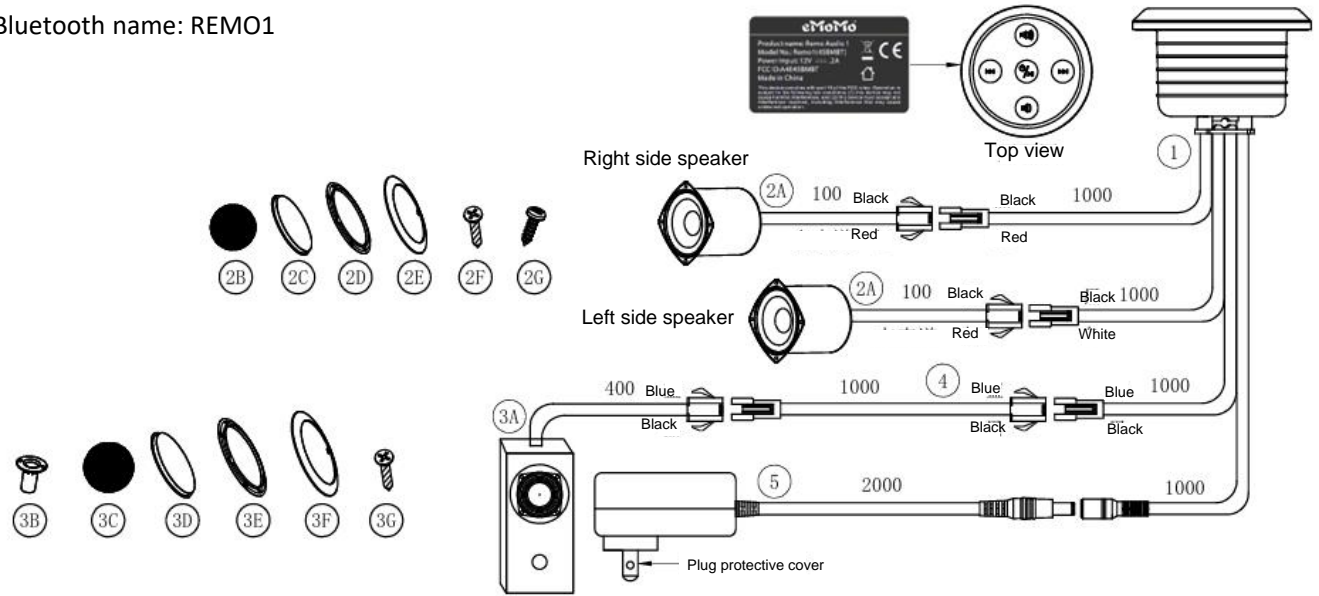

Remo1E User Manual

● Assembly drawing

Bluetooth name: REMO1



● Button Description

Button	Button Name	Function
	Power on/off Pause/Play Disconnect Bluetooth	Press and hold for 3 seconds to turn on the device; press and hold for 5 seconds again to turn off the device. Short press: Pause/play Long press for 3S after powering on: Disconnect Bluetooth connection
	Volume Up	Short press: volume increases step by step Long press: The volume continues to increase. When the volume is at maximum, the voice prompt is: du du
	Volume Down	Short press: volume decreases step by step Long press: Volume down continuously
	Previous track	Short press: Go to the previous track
	Next track	Short press: Go to next track

● Instructions

Connect the product according to the assembly diagram and power on.

A Bluetooth speaker function



1, Long press  for 3 seconds to turn on the device, accompanied by a prompt tone, the

Bluetooth indicator light  flashes slowly in blue, and a voice prompt appears: Bluetooth mode. The product enters the waiting state for pairing. If pairing fails, the Bluetooth indicator light flashes for 30 seconds and then turns off. The product is in the waiting state

for pairing. Long press the power button  for 5 seconds again to turn off the device, accompanied by a prompt tone.

2, Turn on the Bluetooth function on your phone, search for the Bluetooth name " REM01", and pair. After pairing is successful,  the blue light will be on and the voice prompt "Connected" will be heard.

3, Open tracks on your phone and play music. You can control the music on your phone or on the Rem01E operation panel to control the previous track, next track, volume down, volume up, play/pause, etc.



4, Press and hold  for 3 seconds to disconnect the Bluetooth connection. The Bluetooth indicator light  flashes slowly and a voice prompt appears: Disconnect the Bluetooth connection. The phone needs to be paired and connected again before music can be played.

● Product Specifications

Power Input	DC12V2A
Speaker Output	7.5W*2

● Common troubleshooting

Fault	Possible causes and solutions
Unable to power on	1. No power connection. 2. The wire is disconnected or the plug is not fully inserted. 3. The connected socket is faulty.
No sound	1. The extension cable of the speaker is

	<p>disconnected. Please check all connections or reconnect them.</p> <p>2. The product is in pause mode, please press the  button briefly.</p> <p>3. The volume is at minimum. Please press and hold  button .</p>
Bluetooth cannot connect	<p>1. If the device has been connected to another Bluetooth device, press and hold  for 3 seconds to exit the Bluetooth of the other device.</p> <p>2. Beyond the effective range. Please do not connect beyond 8M of this product. Do not try to connect through obstacles.</p>
The music is played by another device	<p>As Bluetooth has a back-connection function, please check whether the phone is paired with two Bluetooth devices at the same time, cancel the pairing of one of them, and click the play button on the phone.</p>