



Furniture of America[®]

E-Commerce by Enitial Lab

ASSEMBLY INSTRUCTIONS

MODEL

CM7913Q

Questions?

GIVE US A CALL: 1-888-980-5122
MON – FRI 8:30AM – 5:30PM (PST)

TOOLS REQUIRED



Allen Wrench

(Included)



Philips Screwdriver

(Not Included)

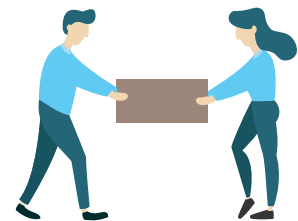
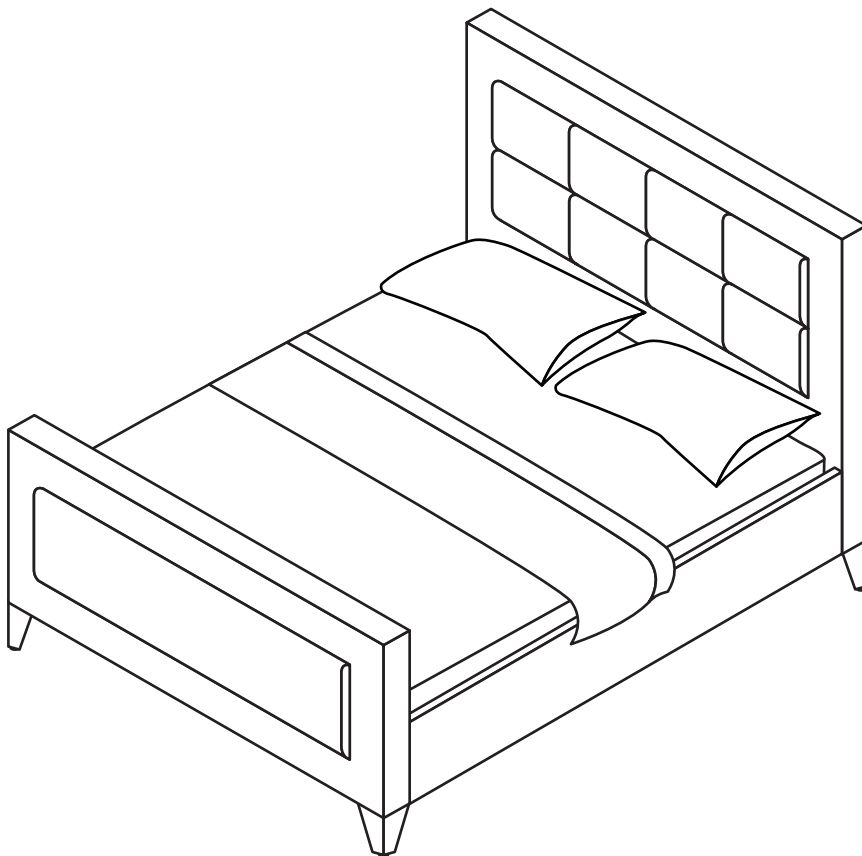

2 - People Recommended

ASSEMBLY RATING



EASY —————> DIFFICULT

The Assembly Rating is a 5-point system showing the level of effort needed to assemble a specific product.



FOA Intro

Thank you for your purchase!

We hope you enjoy this new addition to your home for many years to come.

Our commitment to providing quality products does not simply end when you purchase our product. We fully stand behind our products from start to finish. Our customer service department is available Monday – Friday 8:30 AM – 5:30 PM Pacific and can help with assembly questions as well as, if necessary, replacing damaged or missing parts. To help expedite our service, please have these assembly instructions readily available, along with your order receipt.

 **Consumer Hotline**
Toll-Free 1-888-980-5122

 **WEBSITE**
www.foagroup.com

    foagroup

 **Monday to Friday**
8:30AM- 5:30PM (PST)

 **E-MAIL**
cs.ec@foagroup.com

 FurnitureOfAmerica

CHECK BEFORE STARTING

Are you missing anything?

Double-check all parts, hardware and accessories listed on Page 6 are accounted for.

Should we send any replacements?

Are there any irregularities or flaws in the parts? We can send replacements!

Check out our Quick Tips!

We recommend reviewing the pre-assembly handouts. Even experts need a refresher now and then!

Prep Time!

Please review the assembly instructions and all diagrams prior to assembling. Arrange parts as recommended on Page 7 and group identical hardware together to make assembling easier.

PRE ASSEMBLY INTRODUCTION

We understand building ready-to-assemble furniture can be a challenging experience for some. To help avoid confusion, we have provided some helpful tips that may speed up the process.

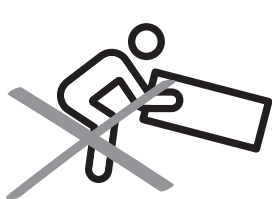

Teamwork

ALWAYS have at least two people to help with transporting and assembling the product to avoid potential injury and/or damage.

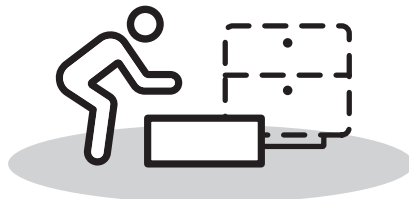
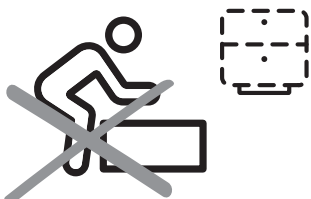

Suitable Location

Assembling near the area of the intended location is highly recommended.



Sufficient Space

Make sure you have enough space to move around during the assembly.

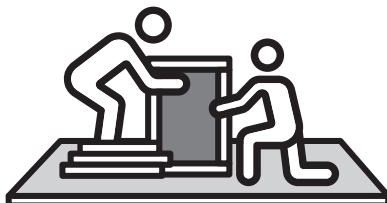

Avoid Scratches

Use cardboard, blankets or a carpeted area while assembling furniture to prevent scratches.

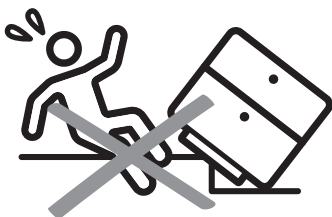

Flat Surface

Make sure the furniture rests on a flat and level surface with each leg evenly touching the floor.

ASSEMBLY AND CARE ADVICE



FAILURE TO FOLLOW THE GUIDELINES BELOW MAY RESULT IN INJURY AND/OR PROPERTY DAMAGE.



Position each part correctly and insert screws or bolts into their respective holes.

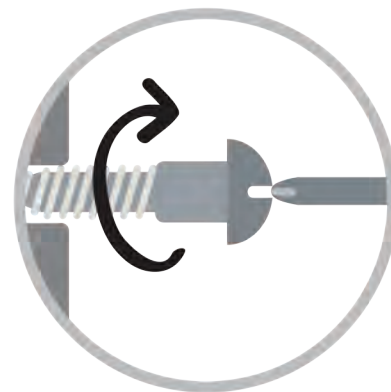

Turn clockwise to tighten and only tighten when step is completed or when instructed to do so.



Use the appropriate hand tools or power tools for assembly. Select steps, such as tightening screws and/or bolts, may require hand tools to avoid causing damage during assembly.



Save the instructions and store any supplied tools for later maintenance.



After two weeks, check and tighten any loose hardware and repeat again every six months thereafter.

IT IS THE USER'S RESPONSIBILITY TO MAINTAIN THE FURNITURE. THE HARDWARE MAY LOOSEN OVER TIME AND MAY CAUSE THE FURNITURE TO BE WOBBLY AND UNABLE TO SUPPORT ITS INTENDED WEIGHT CAPACITY. THIS MAY LEAD TO COLLAPSE AND MAY CAUSE SERIOUS INJURY.

QUEEN SIZE BED

MODEL CM7913Q



- Please keep instructions for future reference.
- Check the quantity and irregularity of parts and hardware before you start.

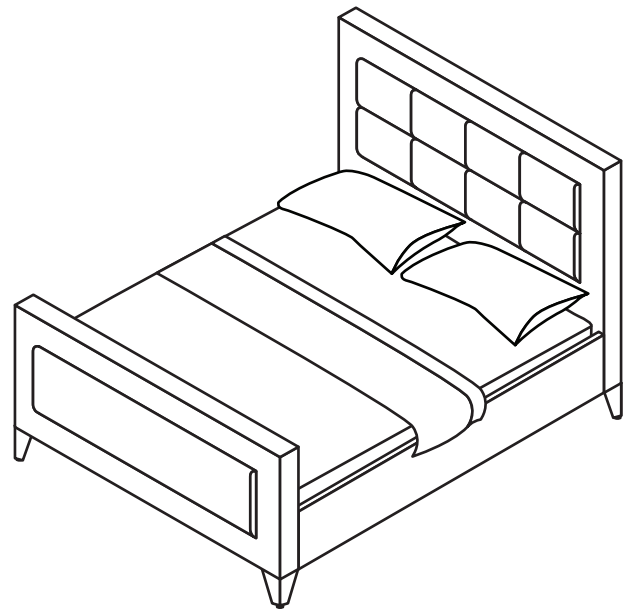

PARTS

#1 1pc



Headboard

#2 1pc



Footboard

#3 2pcs

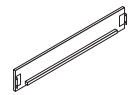

Side Rail

#4 5pcs

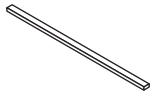

Slat

#5 5pcs



Leg Support (125 x 30 x 30mm)

#6 4pcs



Bed Leg

HARDWARE

#A 1pc



Allen Key M4 With Ball

#B 8pcs



JCBC Bolt M6 x 30mm

#C 5pcs



JCBC Bolt M6 x 45mm

#D 12pcs



CSK Screw M4 x 20mm

#E 10pcs



CSK Screw M4 x 32mm

#F 8pcs



Spring Washer M6

#G 12pcs



Flat Washer Small M6 x 13 x 1.0

#H 8pcs













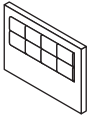

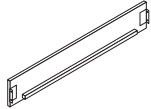

Flat Washer Medium M7 x 19 x 2.0

#I 5pcs

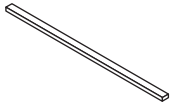

Adjuster

CM7913Q is packed in 3 cases

Carton	Designation	Part		Hardware
CM7913Q-HB	Headboard	#1		
CM7913Q-FB	Footboard	#2		
CM7913Q-R	Side Rail	#3	 2pcs	 #A x 1pc  #B x 8pcs  #C x 5pcs  #D x 12pcs  #E x 10pcs  #F x 8pcs  #G x 12pcs  #H x 8pcs  #I x 5pcs
	Slat	#4	 5pcs	
	Leg Support (125 x 30 x 30mm)	#5	 5pcs	
	Bed Leg	#6	 4pcs	

ASSEMBLY INSTRUCTIONS

1

Part #1 x1pc

Part #2 x1pc

Part #6 x4pcs

Hardware #D x12pcs

Hardware #G x12pcs

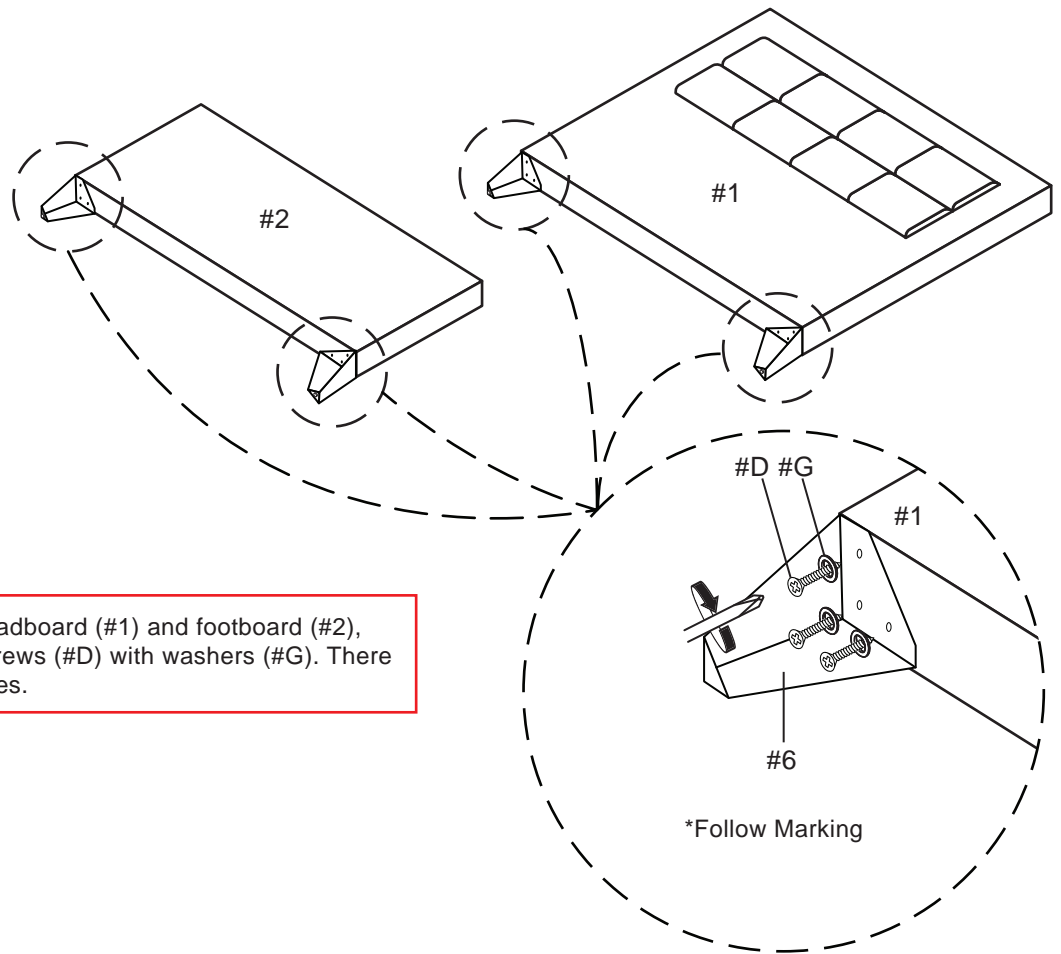

Align legs (#6) to the headboard (#1) and footboard (#2), then secure by using screws (#D) with washers (#G). There will be no pre-drilled holes.

2

Part #3 x2pcs

Hardware #B x8pcs

Hardware #F x8pcs

Hardware #H x8pcs

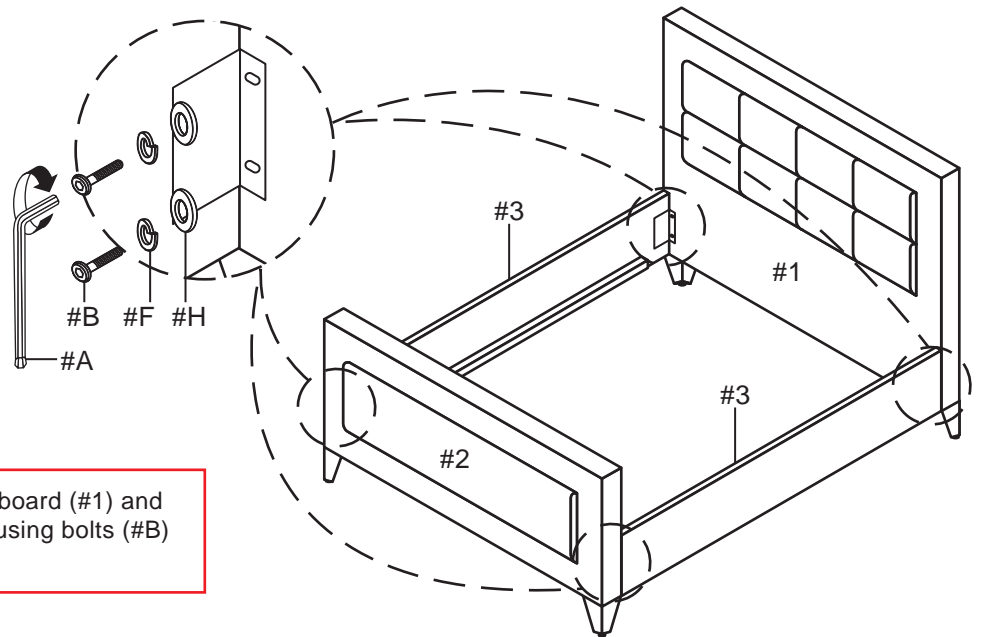

Align side rails (#3) to the headboard (#1) and footboard (#2), then secure by using bolts (#B) with washers (#F, H).

ASSEMBLY INSTRUCTIONS

3

Part (#4) x5pcs

Part (#5) x5pcs

Hardware (#C) x5pcs

Hardware (#I) x5pcs

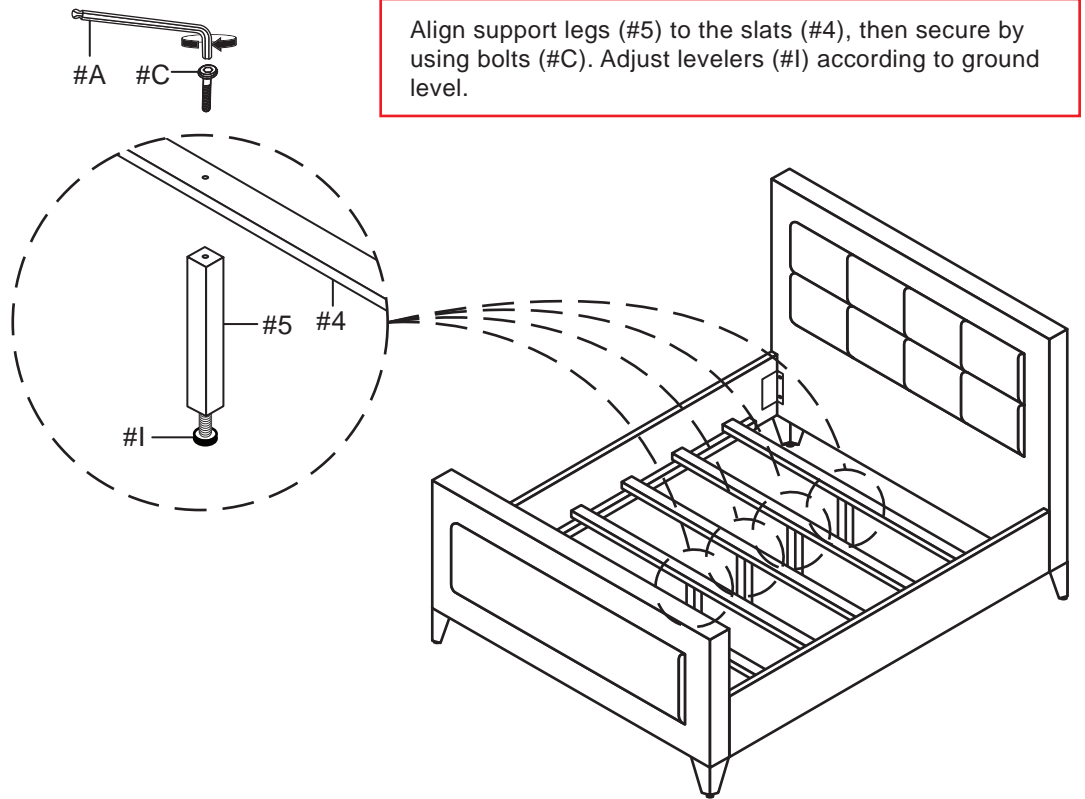

4

Hardware (#E) x10pcs

Align slats (#4) to the side rails (#3), then secure by using screws (#E).

ASSEMBLY COMPLETED

Please ensure the furniture rests on an even and flat surface. If the product wobbles or feels loose, double-check all bolts and/or screws are properly tightened and secured.

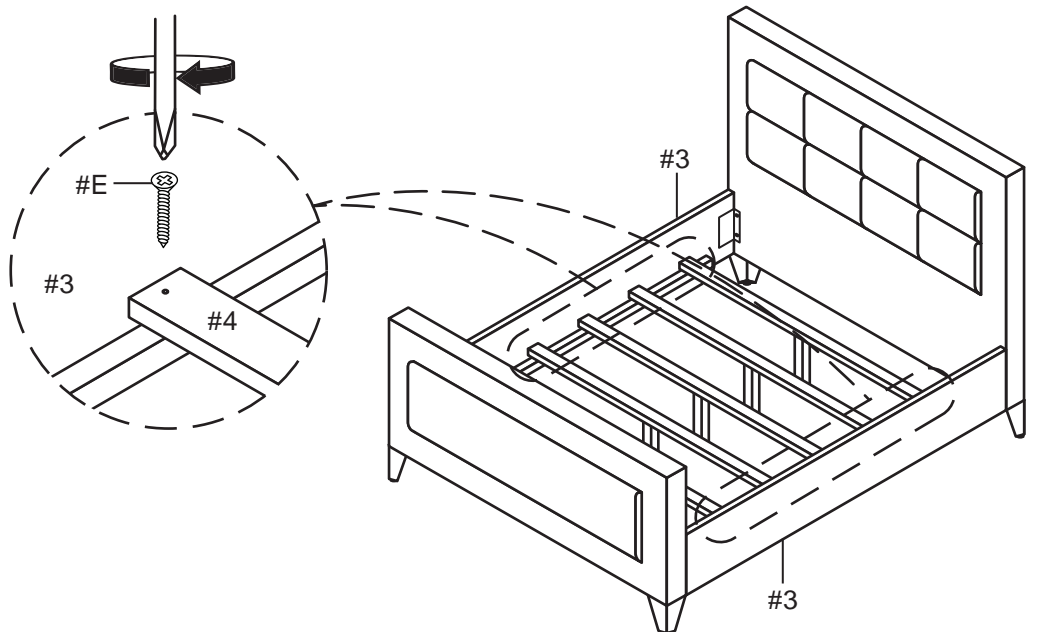

- ✓ **Keep this handy!**
Please retain this instruction manual and any order-related information for future reference.
- ✓ **Lift, don't drag!**
To avoid damage to product please always LIFT the product when transporting or adjusting the placement.