

ASSEMBLY INSTRUCTIONS

Questions?

GIVE US A CALL: 1-888-980-5122
MON – FRI 8:30AM – 5:30PM (PT)

TOOLS REQUIRED



Allen Wrench

(Included)



Phillips
Screwdriver

(Not Included)

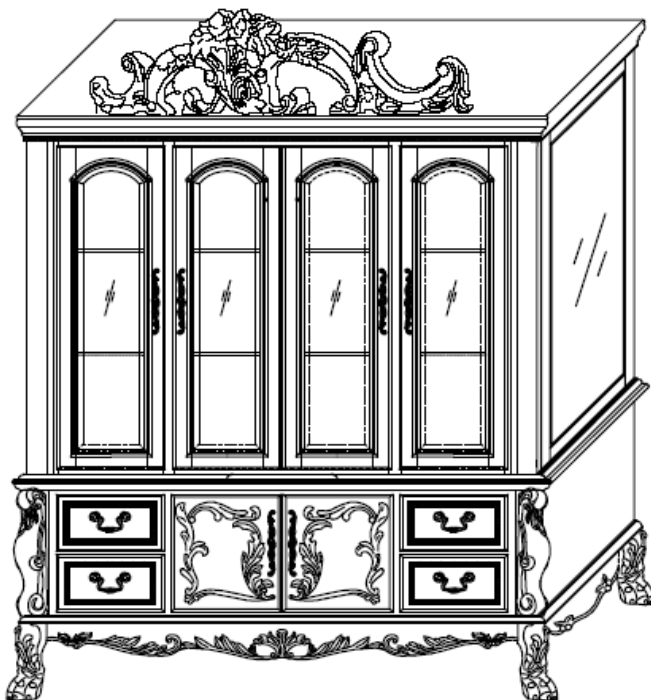

**2 - People
Recommended**

ASSEMBLY RATING



EASY —————> DIFFICULT

The Assembly Rating is a 5-point system showing the level of effort needed to assemble a specific product.



FOA Intro

Thank you for your purchase!

We hope you enjoy this new addition to your home for many years to come.

Our commitment to providing quality products does not simply end when you purchase our product. We fully stand behind our products from start to finish. Our customer service department is available Monday – Friday 8:30 AM – 5:30 PM Pacific Time and can help with assembly questions as well as, if necessary, replacing damaged or missing parts. To help expedite our service, please have these assembly instructions readily available, along with your order receipt.

 **Consumer Hotline**
Toll-Free 1-888-980-5122

 **WEBSITE**
www.foagroup.com

    foagroup

 **Monday to Friday**
8:30AM- 5:30PM (PT)

 **E-MAIL**
cs.ec@foagroup.com

 FurnitureOfAmerica

CHECK BEFORE STARTING

Are you missing anything?
Double-check all parts, hardware and accessories listed are all accounted for.

Should we send any replacements?
Are there any irregularities or flaws in the parts? We can send replacements!

Check out our Quick Tips!
We recommend reviewing the pre-assembly handouts. Even experts need a refresher now and then!

Prep Time!
Please review the assembly instructions and all diagrams prior to assembling.

PRE ASSEMBLY INTRODUCTION

We understand building ready-to-assemble furniture can be a challenging experience for some. To help avoid confusion, we have provided some helpful tips that may speed up the process.

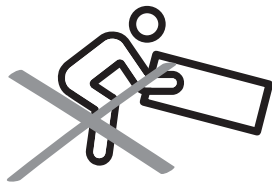

Teamwork

ALWAYS have at least two people to help with transporting and assembling the product to avoid potential injury and/or damage.

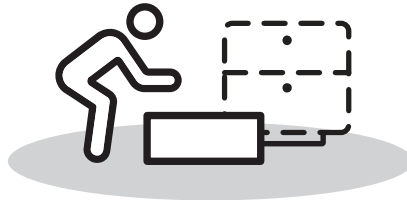
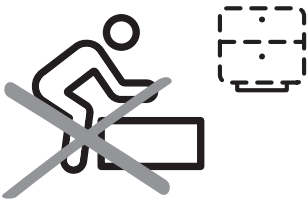

Suitable Location

Assembling near the area of the intended location is highly recommended.



Sufficient Space

Make sure you have enough space to move around during the assembly.



Avoid Scratches

Use cardboard, blankets or a carpeted area while assembling furniture to prevent to prevent scratches and damages.

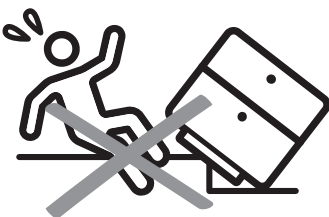

Flat Surface

Make sure the furniture rests on a flat and level surface with each leg evenly touching the floor.

ASSEMBLY AND CARE ADVICE



FAILURE TO FOLLOW THE GUIDELINES BELOW MAY RESULT IN INJURY AND/OR PROPERTY DAMAGE.



Position each part correctly and insert screws or bolts into their respective holes.



Use the appropriate hand tools or power tools for assembly. Select steps, such as tightening screws and/or bolts, may require hand tools to avoid causing damage during assembly.

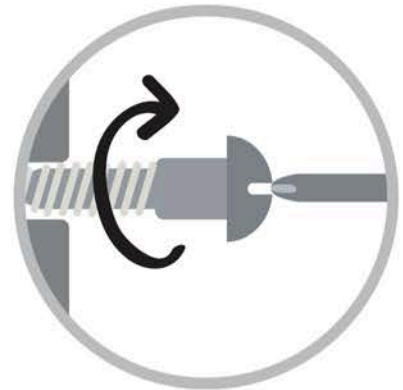

Turn clockwise to tighten and only tighten when step is completed or when instructed to do so.



Save the instructions and store any supplied tools for later maintenance.

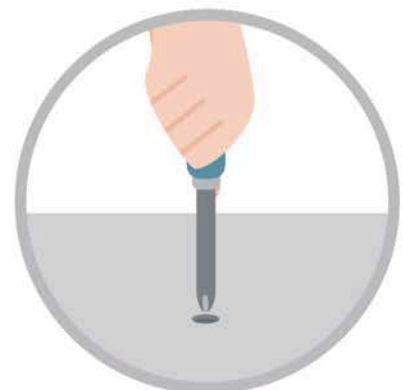

After two weeks, check and tighten any loose hardware and repeat again every six months thereafter.

IT IS THE USER'S RESPONSIBILITY TO MAINTAIN THE FURNITURE. THE HARDWARE MAY LOOSEN OVER TIME AND MAY CAUSE THE FURNITURE TO BE WOBBLY AND UNABLE TO SUPPORT ITS INTENDED WEIGHT CAPACITY. THIS MAY LEAD TO COLLAPSE AND MAY CAUSE SERIOUS INJURY.

HUTCH WITH 4 DOORS AND BUFFET

CM3557H/B



- Please keep instructions for future reference.
- Check the quantity and irregularity of parts and hardware before you start.

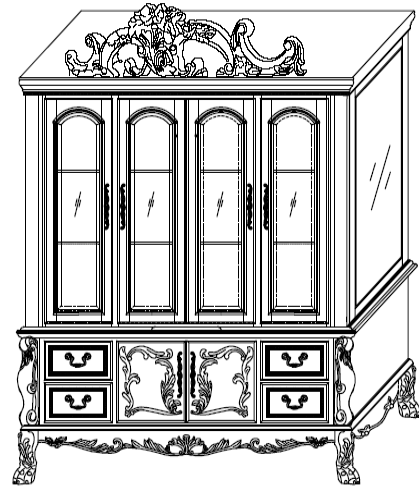

PARTS

#1 1 pc



Ornate

#2 1 pc

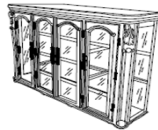

Hutch

#3 1pc



Buffet Table

#4 2 pcs



Front Leg

#5 2 pcs



Rear Leg

HARDWARE

#A 11 pcs



Bolt 5/16 x 2"

#B 11 pcs



Lock Washer

#C 11 pcs



Flat Washer

#D 2pcs



Allen Wrench

#E 2pcs







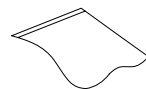





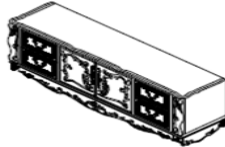

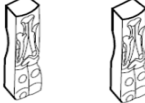

Screw 5/8"

#F 1set



Furniture Tipping Restraint

C M3557H/B Points 2 cartons

Cartons	Designation	Part	Hardware
CM3557H/B-1	Buffet Table	 #3	 #A x 8 pcs  #B x 8 pcs  #C x 8 pcs  #D x 1pc #A x 3pcs
	Front Leg	 #4	
	Rear Leg	 #5	
CM3557H/B-2	Ornate	 #1	 #A x 3pcs  #B x 3pcs  #C x 3pcs  #D x 1pc  #E x 2 pcs  #F x 1set
	Hutch	 #2	

ASSEMBLY INSTRUCTIONS

- 1** Part #1 x1pc
 Part #2 x1pc
 Hardware #A x3pcs
 Hardware #B x3pcs
 Hardware #C x3pcs

Turn right (clockwise) to tighten

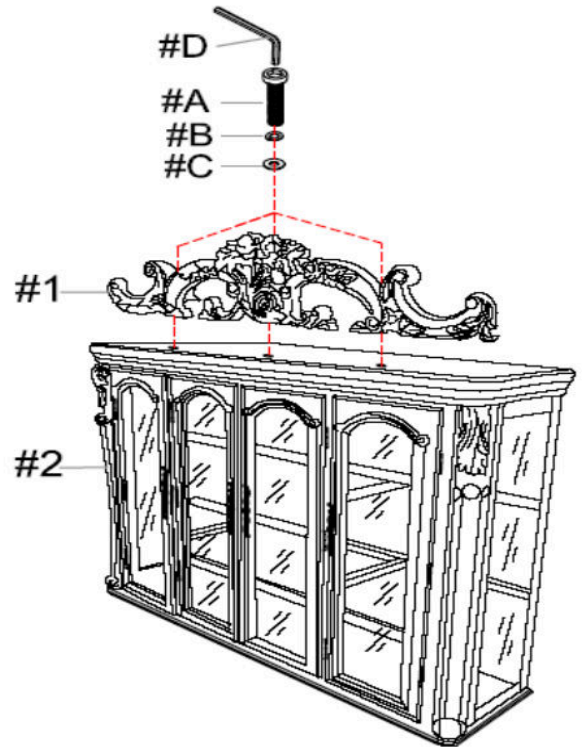

- I. Align the ornate (#1) with the pre-drilled holes on top of the hutch (#2).
- II. Prepare 3 bolt assemblies by inserting FIRST the lock washer (#B) onto the bolt (#A) and then the flat washer (#C) onto the SAME bolt (#A), in that order.
- III. Insert the bolt assemblies through the pre-drilled holes of the ornate (#1) using the Allen wrench (#D) to lock them with the hutch (#2).

- 2** Part #4 x2pcs
 Part #5 x2pcs
 Hardware #A x8pcs
 Hardware #B x8pcs
 Hardware #C x8pcs

Turn right (clockwise) to tighten

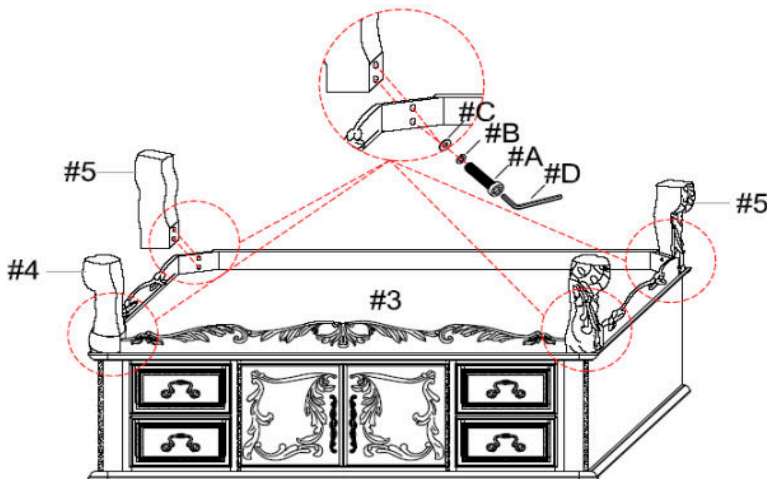

- I. With the help of another person, carefully place the buffet table (#3) facing down on a protected surface.
- II. Align the 2 front legs (#4) and the 2 rear legs (#5) with the pre-drilled holes on the corners of the buffet table (#3).
- III. Prepare 8 bolt assemblies by inserting FIRST the lock washer (#B) onto the bolt (#A) and then the flat washer (#C) onto the SAME bolt (#A), in that order.
- IV. Insert the bolt assemblies through the pre-drilled holes of the buffet table (#3) using the Allen wrench (#D) to lock them with the 2 front legs (#4) and the 2 rear legs (#5).

ASSEMBLY INSTRUCTIONS

3 Hardware x2pcs

- I. With the help of another person, carefully place the hutch (#2) on top of the buffet table (#3).
- II. There are two mounting brackets already attached behind the hutch (#2). Loosen the screws in order to position the brackets vertically to align with the pre-drilled holes of the buffet table (#3).
- III. Insert the screws (#E) through the brackets and secure those screws using the Phillips screwdriver to lock them with the buffet table (#3). Remember to tighten the screws that were already attached from the factory.

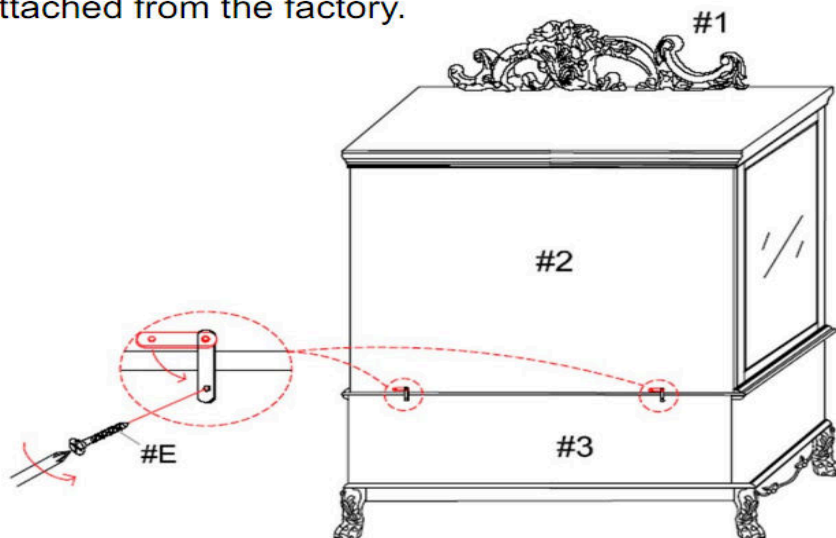

4

Hardware  x1Set

Make sure the unit is rested on a flat surface and does not feel loose or wobbly. If it does, double check that the bolts are secured and properly tightened.

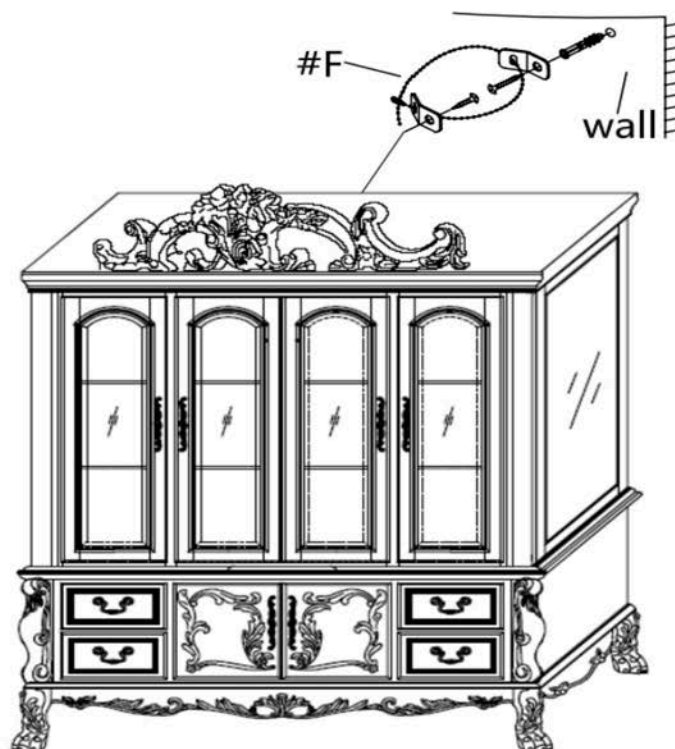

ASSEMBLY IS COMPLETED

ASSEMBLY INSTRUCTIONS

Wall Mounting and Fixing



EXPANSION WALL ANCHOR

Our provided expansion wall anchors are only suitable for masonry walls, such as drywall, plaster or concrete, and are best for holding lightweight items or for anti-tip prevention. If you are unsure of the correct wall anchor to use with the product, please request professional guidance. Liability for product damage or failure due to using the incorrect anchors will fall on the installer.

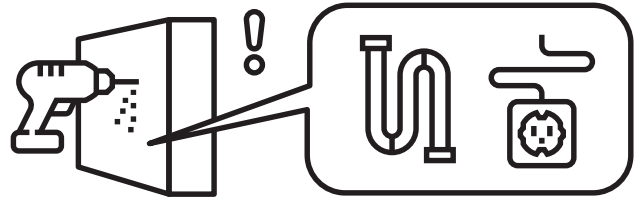

CHECK BEFORE PROCEEDING

Prior to drilling or hammering, please check for wires or pipes. We recommend using a stud finder to locate a stud, which will offer more appropriate resistance and hold more weight.

QUICK TIPS

1. If unsure of the proper size, always choose a larger screw and wall anchor.

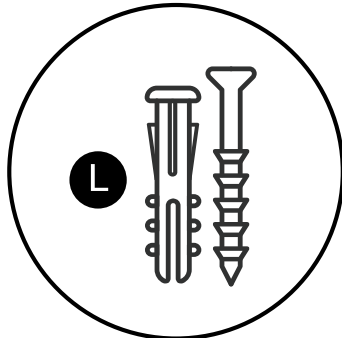

2. Match the drill bit to the wall anchor and hole size.

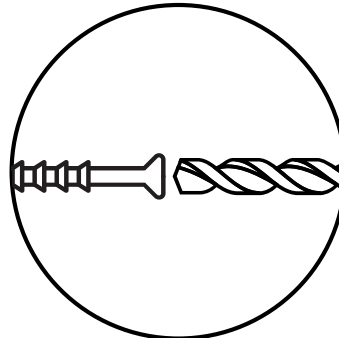

3. Only drill horizontally. Do not force the drill or enlarge the hole for the wall anchor.

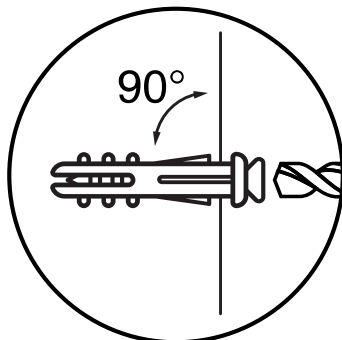

4. Take extra care when drilling into high walls or ceramic tiles. Wall anchors should be a tight fit for the hole. Never use wall anchors in ceilings.

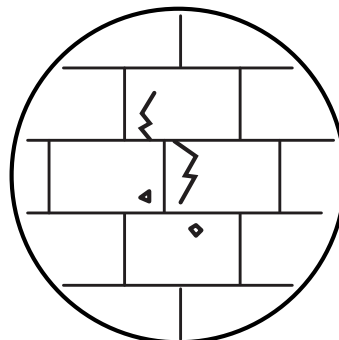

MAINTENANCE



We recommend a yearly check to see if the wall anchor or screw has loosened. If so, please remove the existing wall anchor and screw, and use a new anchor.