

ASSEMBLY INSTRUCTIONS

MODEL #

CM-OS2139

Questions?

GIVE US CALL: 1-888-980-5122
MON-FRI 8:30AM - 5:30PM (PST)

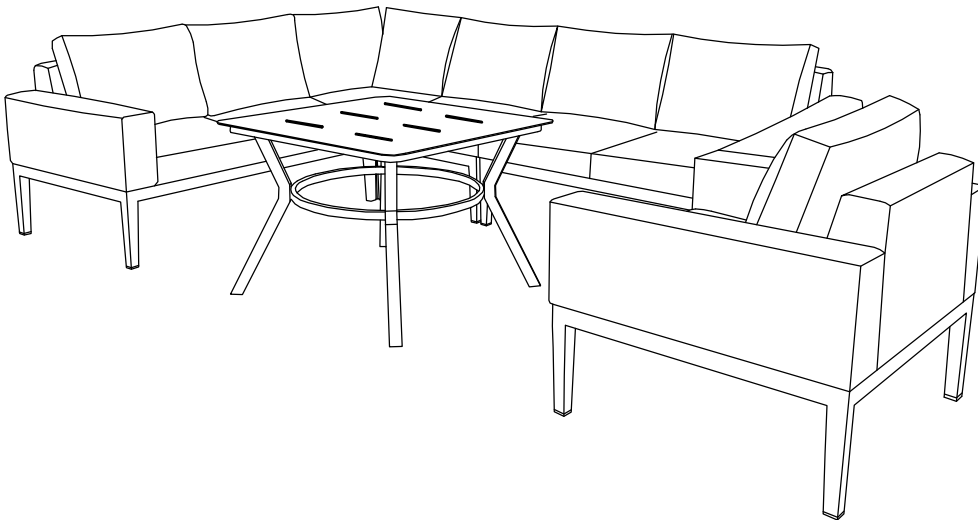

TOOLS REQUIRED



Allen Wrench

(Included)

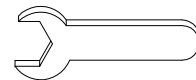

Wrench

(Included)



**2 - Persons
Recommended**

ASSEMBLY RATING

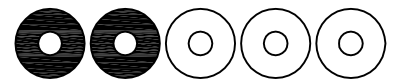

EASY —————> DIFFICULT

The Assembly Rating is a 5-point system showing the level of effort needed to assemble a specific product.





FOA Intro

Thank you for your purchase!

We hope you enjoy this new addition to your home for many years to come.

Our commitment to providing quality products does not simply end when you purchase our product. We fully stand behind our products from start to finish. Our customer service department is available Monday – Friday 8:30 AM – 5:30 PM Pacific and can help with assembly questions as well as, if necessary, replacing damaged or missing parts. To help expedite our service, please have these assembly instructions readily available, along with your order receipt.

 **Consumer Hotline**
Toll-Free 1-888-980-5122

 **Monday to Friday**
8:30AM- 5:30PM (PST)

 **WEBSITE**
www.foagroup.com

 **E-MAIL**
cs.ec@foagroup.com

    foagroup

 FurnitureOfAmerica

CHECK BEFORE STARTING

Are you missing anything?

Double-check all parts, hardware and accessories listed on Page 6 are accounted for.

Check out our Quick Tips!

We recommend reviewing the pre-assembly handouts. Even experts need a refresher now and then!

Should we send any replacements?

Are there any irregularities or flaws in the parts? We can send replacements!

Prep Time!

Please review the assembly instructions and all diagrams prior to assembling. Arrange parts as recommended on Page 7 and group identical hardware together to make assembling easier.

PRE ASSEMBLY INTRODUCTION

We understand building ready-to-assemble furniture can be a challenging experience for some. To help avoid confusion, we have provided some helpful tips that may speed up the process.

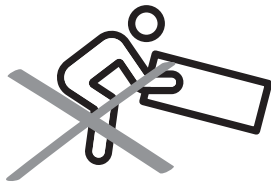

Teamwork

ALWAYS have at least two people to help with transporting and assembling the product to avoid potential injury and/or damage.

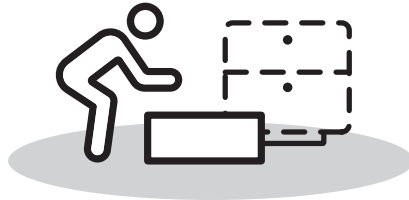
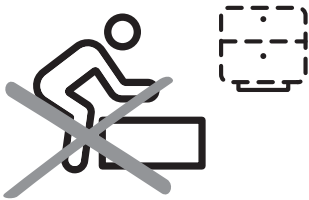

Suitable Location

Assembling near the area of the intended location is highly recommended.



Sufficient Space

Make sure you have enough space to move around during the assembly.

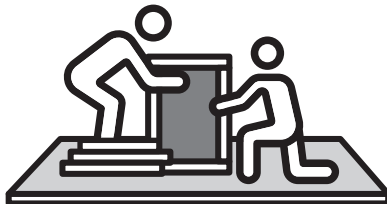

Avoid Scratches

Use cardboard, blankets or a carpeted area while assembling furniture to prevent scratches.

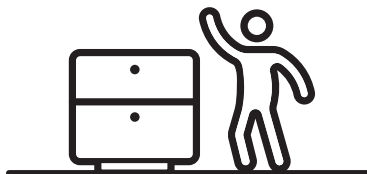
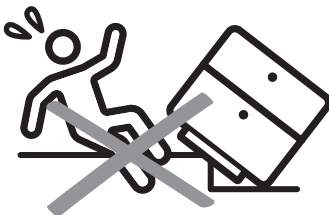

Flat Surface

Make sure the furniture rests on a flat and level surface with each leg evenly touching the floor.

ASSEMBLY AND CARE ADVICE



FAILURE TO FOLLOW THE GUIDELINES BELOW MAY RESULT IN INJURY AND/OR PROPERTY DAMAGE.



Position each part correctly and insert screws or bolts into their respective holes.

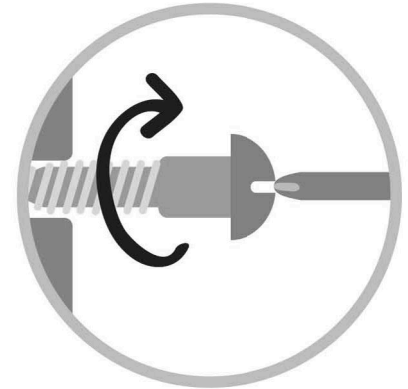

Turn clockwise to tighten and only tighten when step is completed or when instructed to do so.



Save the instructions and store any supplied tools for later maintenance.

Use the appropriate hand tools or power tools for assembly. Select steps, such as tightening screws and/or bolts, may require hand tools to avoid causing damage during assembly.



After two weeks, check and tighten any loose hardware and repeat again every six months thereafter.

IT IS THE USER'S RESPONSIBILITY TO MAINTAIN THE FURNITURE. THE HARDWARE MAY LOOSEN OVER TIME AND MAY CAUSE THE FURNITURE TO BE WOBBLY AND UNABLE TO SUPPORT ITS INTENDED WEIGHT CAPACITY. THIS MAY LEAD TO COLLAPSE AND MAY CAUSE SERIOUS INJURY.

SECTIONAL

CM-OS2139



- Please keep instructions for future reference.
- Check the quantity and irregularity of parts and hardware before you start.

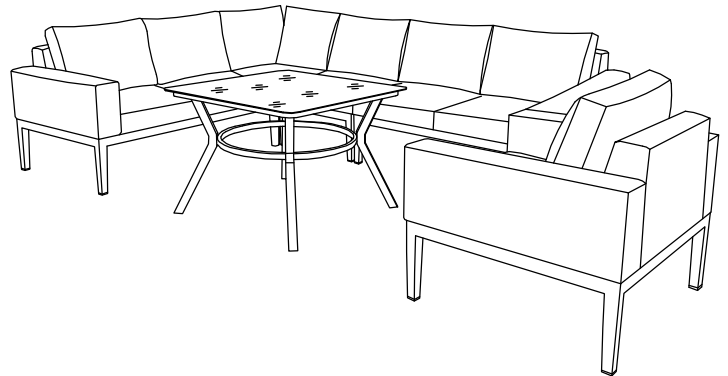

PARTS

#1 1pc

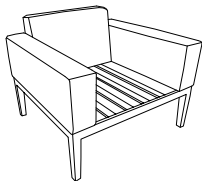

Single Sofa

#2 1pc

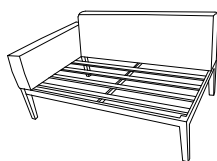

Left Loveseat

#3 1pc

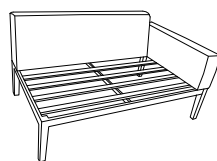

Right Loveseat

#4 1pc

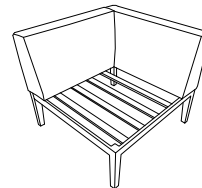

Corner

#5 1pc



Side Chair

#6 1pc

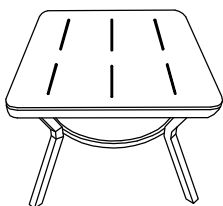

Coffee Table

#7 7pcs

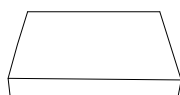

Seat Cushion

#8 7pcs



Back Cushion A

#9 1pc

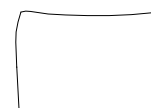

Back Cushion B

HARDWARE

#A 3pcs



Bolt-M8*70

#B 6pcs



Flat Washer

#C 3pcs



Nut

#D 1pc

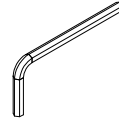





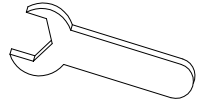





















Allen Wrench

#E 1pc



Allen Wrench

CM-OS2139 Points 4 cartons

Carton	Designation	Part	Hardware
CM-OS2139-LV	Left Loveseat	#2  1pc	#A  2pcs
	Right Loveseat	#3  1pc	#B  4pcs
	Seat Cushion	#7  4pcs	#C  2pcs
	Back Cushion A	#8  4pcs	#D  1pc #E  1pc
CM-OS2139-CNRAS	Side Chair	#5  1pc	#A  2pcs
	Corner	#4  1pc	#B  4pcs
	Seat Cushion	#7  2pcs	#C  2pcs
	Back Cushion A	#8  2pcs	#D  1pc
	Back Cushion B	#9  1pc	#E  1pc
CM-OS2139-CH	Single Sofa	#1  1pc	
	Seat Cushion	#7  1pc	
	Back Cushion A	#8  1pc	
CM-OS2139-T	Coffee Table	#6  1pc	#A  12pcs #B  12pcs #C  1pc

ASSEMBLY INSTRUCTIONS

1

Part **#1** ×1pc

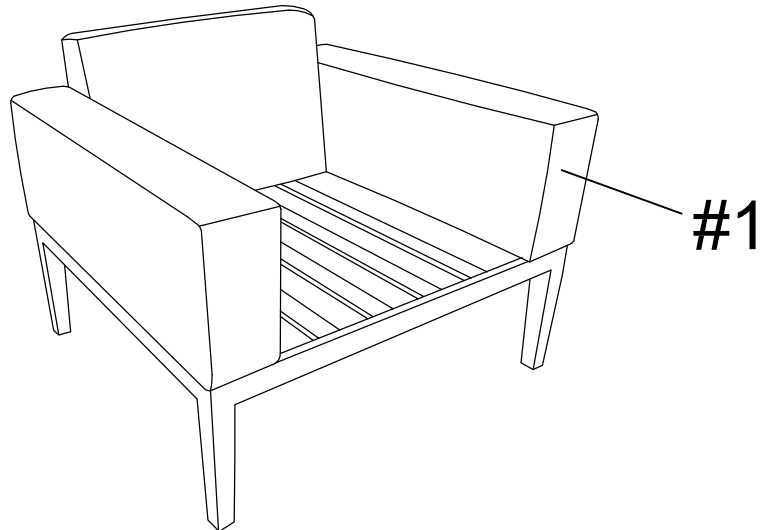

2

Part **#7** ×1pc

Part **#8** ×1pc

Place cushions (#7,8) to the single sofa (#1).

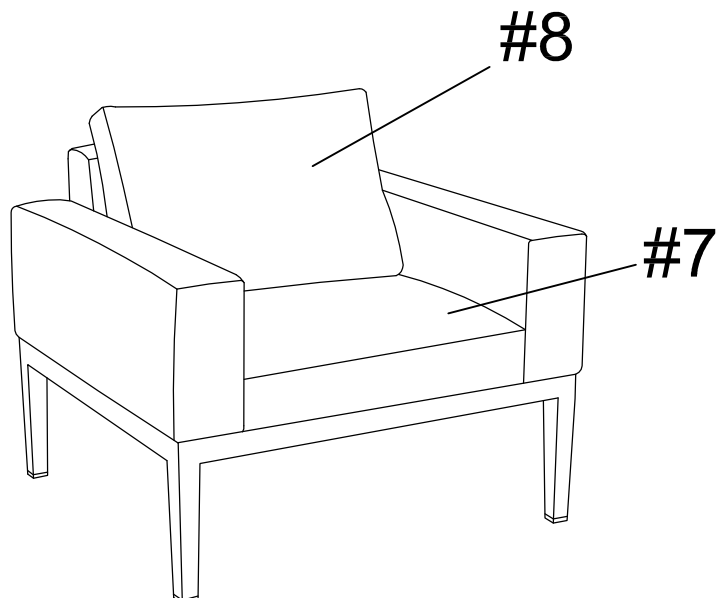

ASSEMBLY INSTRUCTIONS

3

Part **#2** ×1pc

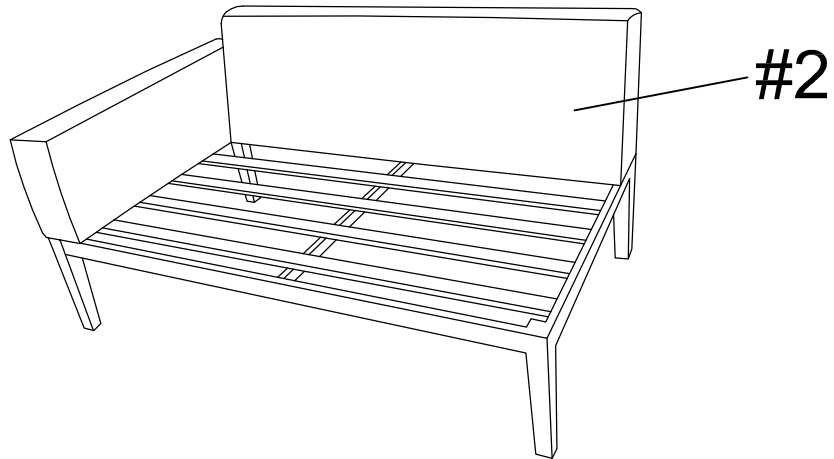

4

Part **#7** ×2pcs

Part **#8** ×2pcs

Place cushions (#7,8) onto left loveseat (#2).

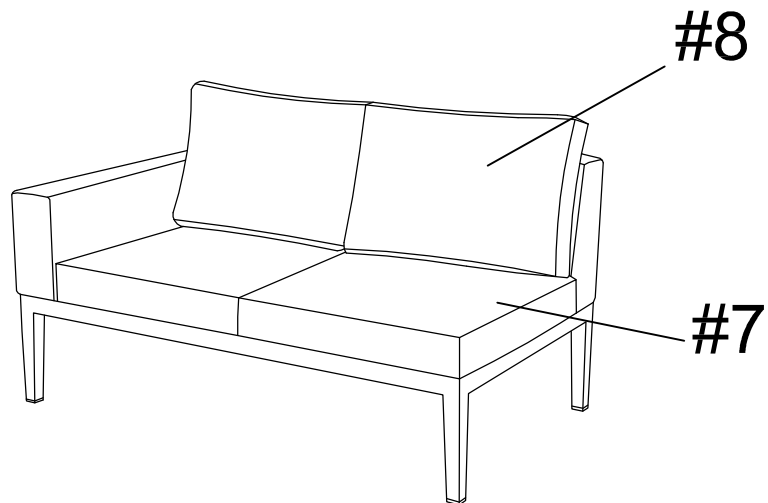

ASSEMBLY INSTRUCTIONS

5

Part **#3** ×1pc

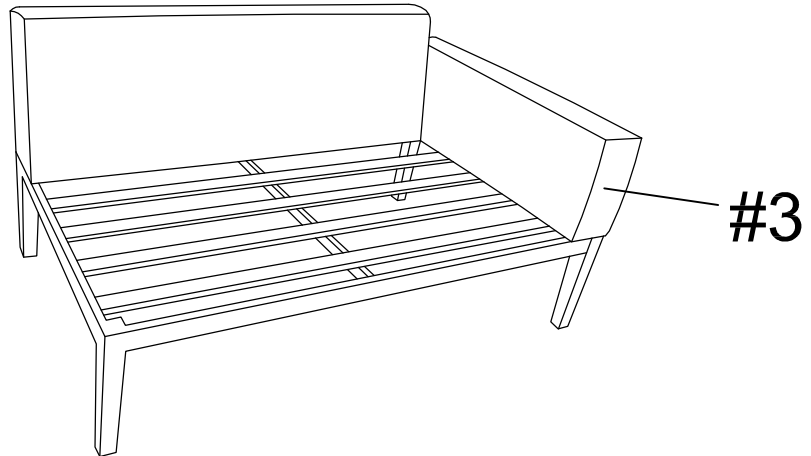

6

Part **#7** ×2pcs

Part **#8** ×2pcs

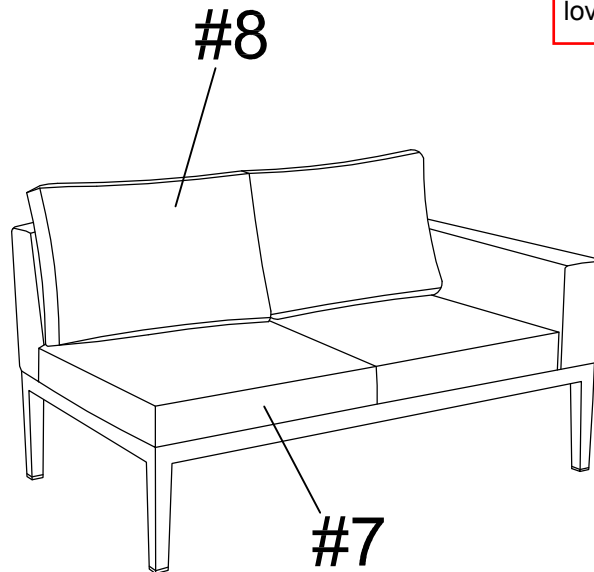

Place cushions (#7,8) onto right loveseat (#3).

ASSEMBLY INSTRUCTIONS

7

Part **#4** ×1pc

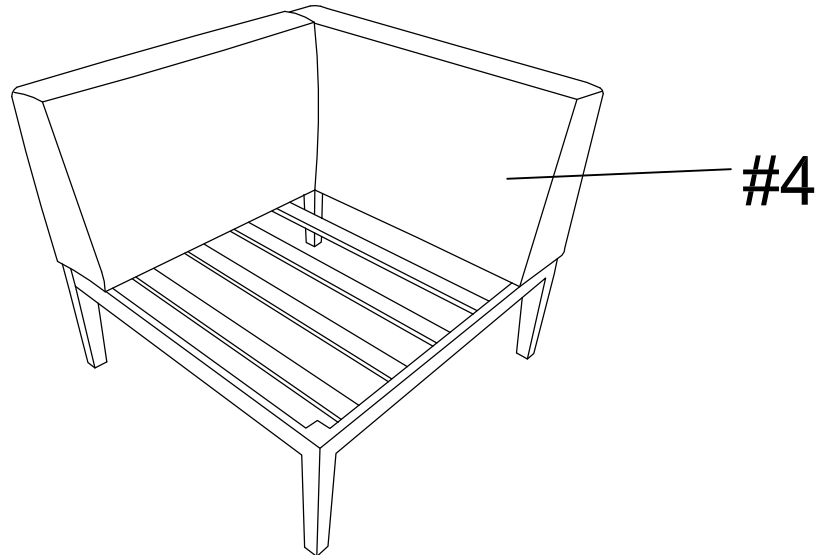

8

Part **#7** ×1pc

Part **#8** ×1pc

Part **#9** ×1pc

Place cushions (#7,8,9) onto corner (#4).

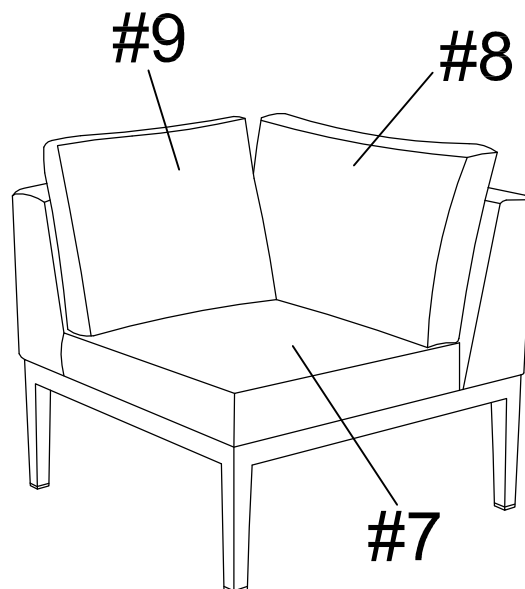

ASSEMBLY INSTRUCTIONS

9

Part (#5) ×1pc

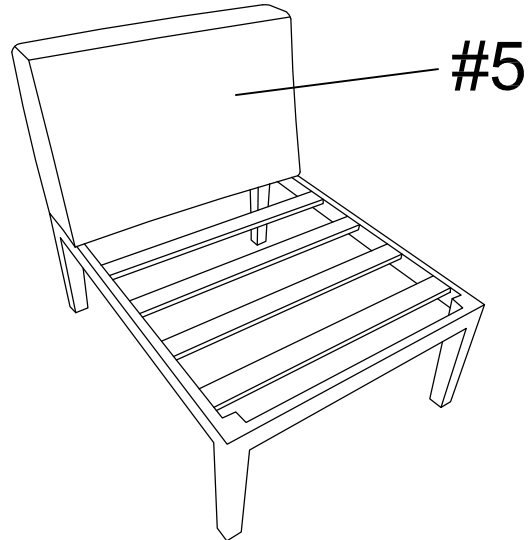

10

Part (#7) ×1pc

Part (#8) ×1pc

Place cushions (#7,8) onto side chair (#5).

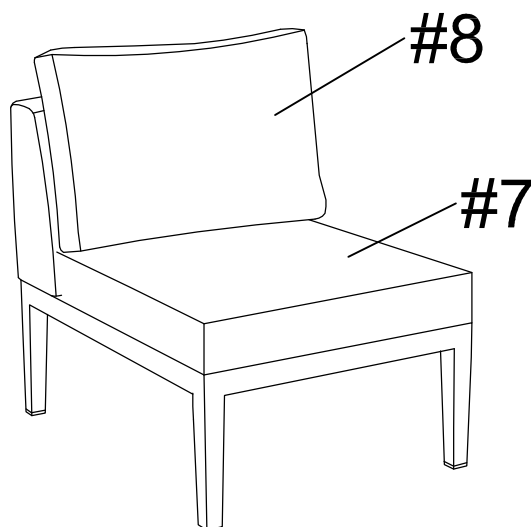

ASSEMBLY INSTRUCTIONS

11

Part #6 × 1pc

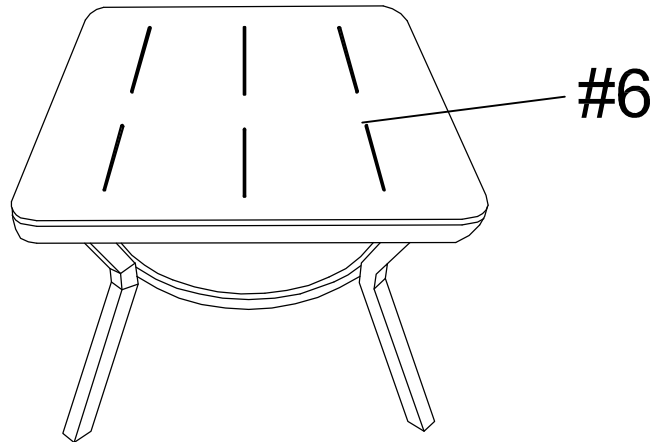

12

Hardware #A × 3pcs

Hardware #B × 6pcs

Hardware #C × 3pcs

Hardware #D × 1pc

Hardware #E × 1pc

Align furniture together, then secure by using bolts (#A) with washers (#B) to nuts (#C),

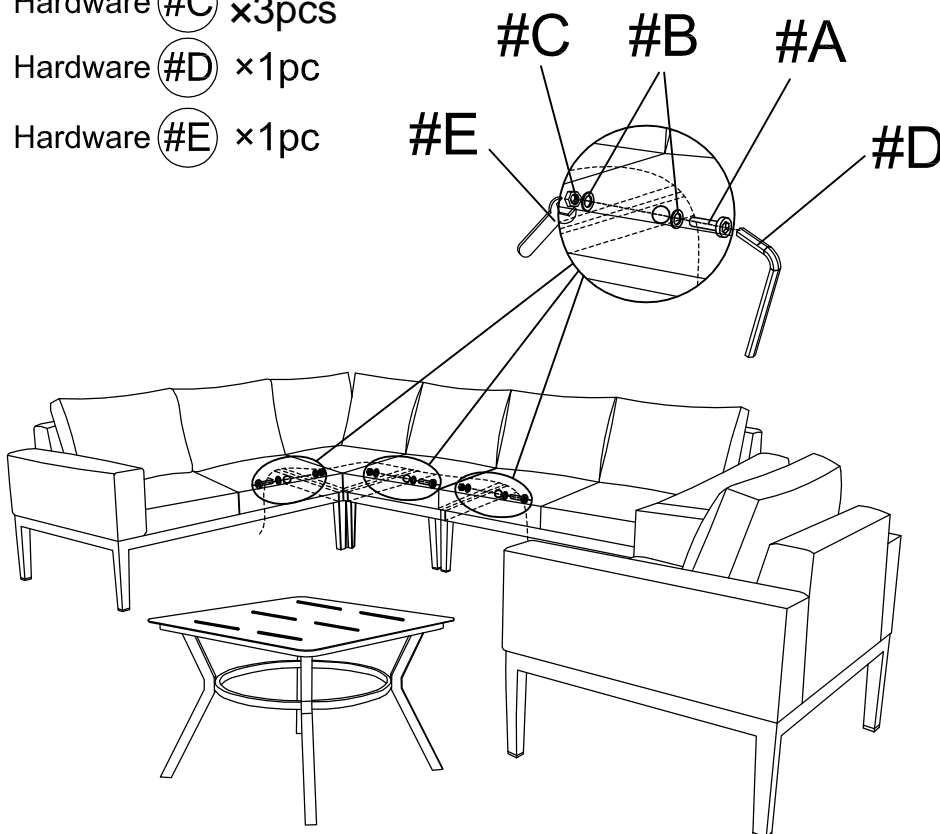

ASSEMBLY COMPLETED



Please ensure the furniture rests on an even and flat surface. If the product wobbles or feels loose, double-check all bolts and/or screws are properly tightened and secured.

✓ **Keep this handy!**

Please retain this instruction manual and any order-related information for future reference.

✓ **Lift, don't drag!**

To avoid damage to product please always LIFT the product when transporting or adjusting the placement.