



Furniture of America®

ASSEMBLY INSTRUCTIONS

MODEL #

CM-BK265

Questions?

GIVE US CALL: 1-888-980-5122
MON-FRI 8:30AM - 5:30PM (PST)

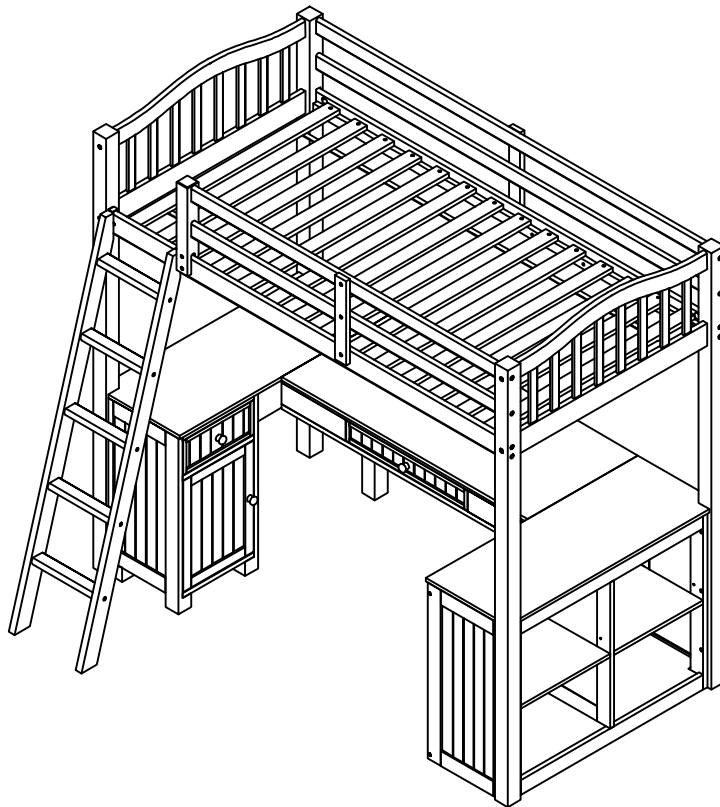

TOOLS REQUIRED



Allen Wrench

(Included)



Phillips
Screwdriver

(Not Included)



**3- People
Recommended**

ASSEMBLY RATING



EASY —————> DIFFICULT

The Assembly Rating is a 5-point system showing the level of effort needed to assemble a specific product.



FOA Intro

Thank you for your purchase!

We hope you enjoy this new addition to your home for many years to come.

Our commitment to providing quality products does not simply end when you purchase our product. We fully stand behind our products from start to finish. Our customer service department is available Monday – Friday 8:30 AM – 5:30 PM Pacific and can help with assembly questions as well as, if necessary, replacing damaged or missing parts. To help expedite our service, please have these assembly instructions readily available, along with your order receipt.

 **Consumer Hotline**
Toll-Free 1-888-980-5122

 **WEBSITE**
www.foagroup.com

    foagroup

 **Monday to Friday**
8:30AM- 5:30PM (PST)

 **E-MAIL**
cs.ec@foagroup.com

 FurnitureOfAmerica

CHECK BEFORE STARTING

Are you missing anything?

Double-check all parts, hardware and accessories listed on Page 6 are accounted for.

Should we send any replacements?

Are there any irregularities or flaws in the parts? We can send replacements!

Check out our Quick Tips!

We recommend reviewing the pre-assembly handouts. Even experts need a refresher now and then!

Prep Time!

Please review the assembly instructions and all diagrams prior to assembling. Arrange parts as recommended on Page 7 and group identical hardware together to make assembling easier.

PRE ASSEMBLY INTRODUCTION

We understand building ready-to-assemble furniture can be a challenging experience for some. To help avoid confusion, we have provided some helpful tips that may speed up the process.

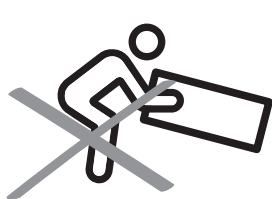

Teamwork

ALWAYS have at least two people to help with transporting and assembling the product to avoid potential injury and/or damage.

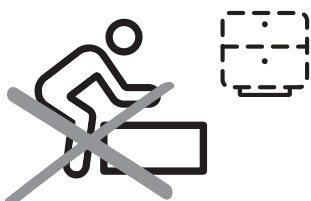

Suitable Location

Assembling near the area of the intended location is highly recommended.



Sufficient Space

Make sure you have enough space to move around during the assembly.

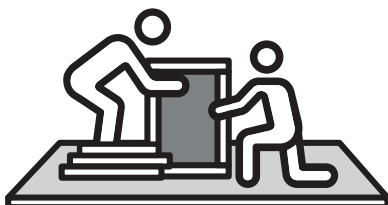

Avoid Scratches

Use cardboard, blankets or a carpeted area while assembling furniture to prevent scratches.

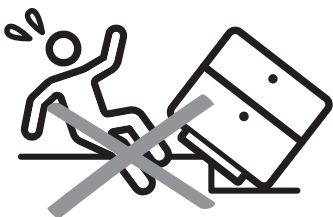

Flat Surface

Make sure the furniture rests on a flat and level surface with each leg evenly touching the floor.

ASSEMBLY AND CARE ADVICE



FAILURE TO FOLLOW THE GUIDELINES BELOW MAY RESULT IN INJURY AND/OR PROPERTY DAMAGE.



Position each part correctly and insert screws or bolts into their respective holes.

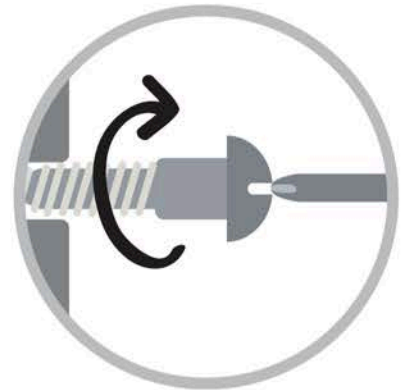

Turn clockwise to tighten and only tighten when step is completed or when instructed to do so.



Use the appropriate hand tools or power tools for assembly. Select steps, such as tightening screws and/or bolts, may require hand tools to avoid causing damage during assembly.



Save the instructions and store any supplied tools for later maintenance.

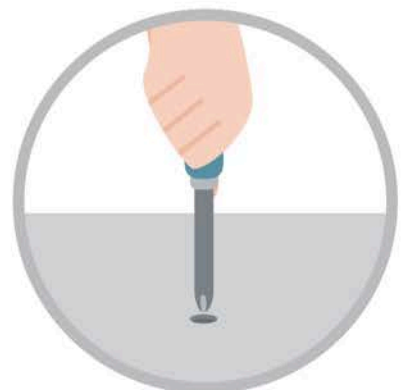

After two weeks, check and tighten any loose hardware and repeat again every six months thereafter.

IT IS THE USER'S RESPONSIBILITY TO MAINTAIN THE FURNITURE. THE HARDWARE MAY LOOSEN OVER TIME AND MAY CAUSE THE FURNITURE TO BE WOBBLY AND UNABLE TO SUPPORT ITS INTENDED WEIGHT CAPACITY. THIS MAY LEAD TO COLLAPSE AND MAY CAUSE SERIOUS INJURY.

DESK BED

CM-BK265

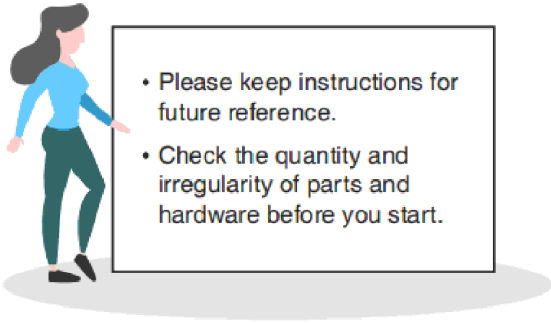

PARTS

#1 1pc



Left Back Post

#2 1pc



Left Front Post

#3 1pc



Right Back Post

#4 1pc



Right Front Post

#5 2pcs

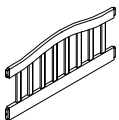

Frame HB

#6 1pc

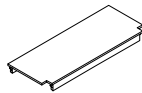

Right Bookcase
Top Panel

#7 1pc

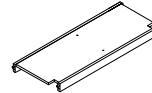

Right Bookcase
Bottom Panel

#8 1pc

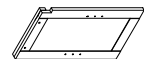

Right Bookcase
Center Panel

#9 1pc

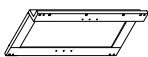

Right Bookcase
Left Panel

#10 1pc



Right Bookcase
Right Panel

#11 2pcs

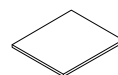

Right Bookcase
Shelf Panel

#12 1pc

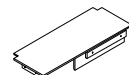

NightStand
Top Panel

#13 1pc

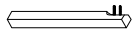

Leg

#14 1pc



NightStand

#15 1pc

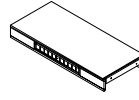

Desk

#16 1pc

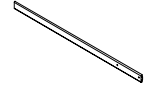

Front Rail

#17 1pc

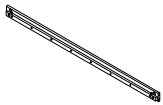

Back Rail

#18 2pcs

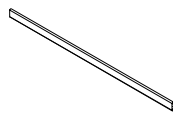

Long Guardrail

#19 2pcs

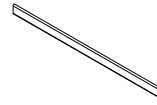

Short Guardrail

#20 1pc

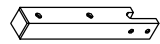

Guardrail Attachment

#21 2pcs

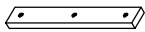

Guardrail Support

#22 1pc



Ladder Rail (Left Side)

#23 1pc



Ladder Rail (Right Side)

#24 5pcs

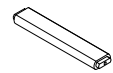

Ladder Step

#25 1Set

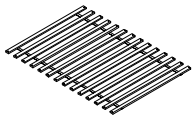

Slat (14pcs)

HARDWARE

#A 8sets

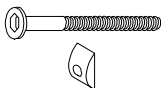

Bolt 1/4" x 4"
Half Round Nut

#B 3pcs



Bolt 1/4" x 3"

#C 2pcs



Bolt 1/4" x 2-1/2"

#D 2pcs



Bolt 1/4" x 2"

#E 24pcs



Bolt
1/4" x 1-3/16"

#F 14pcs



Screw
6.3 x 3-1/2"

#G 10pcs



Screw
6.3 x 2"

#H 2pcs



Screw
6.3 x 2"

#I 34pcs



Screw
4 x 30mm

#J 6pcs



Screw
4 x 20mm

#K 8pcs



Screw
3 x 12mm

#L 8pcs



Small L Shape
Connection Bracket

#M 2pcs



Big L shape
Connection
Bracket

#N 26pcs



Wood Dowel
Ø10 x 40mm

#O 2pcs



Hex Nut
5/16"

#P 2pcs



Lock Washer
5/16"

#Q 4pcs



Flat Washer
5/16"

#R 1pc

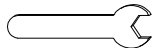

Wrench

#S 1pc

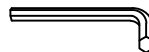

Allen Wrench
4mm

#T 2pcs







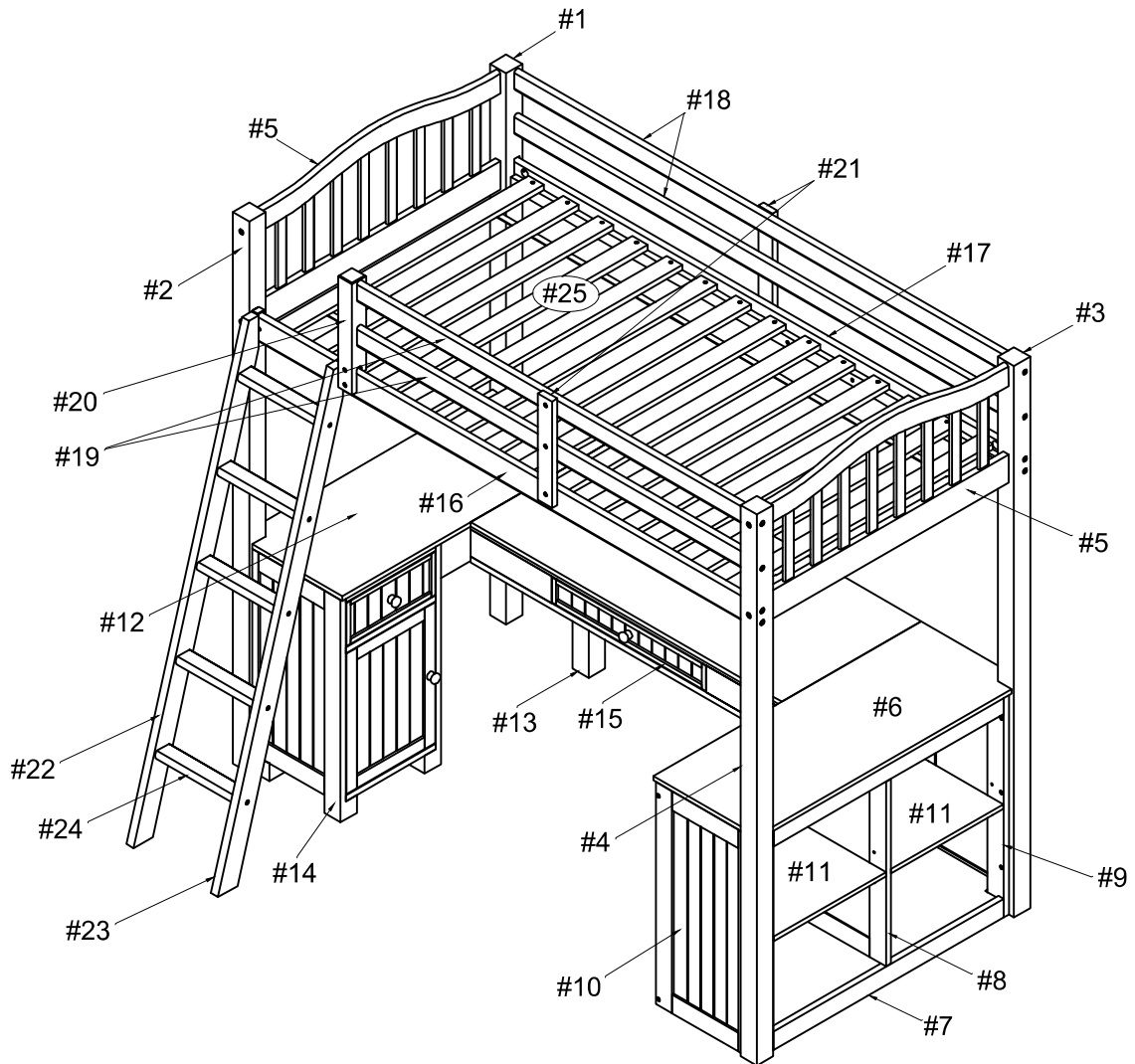







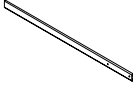
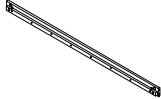

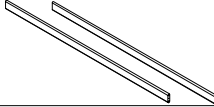

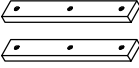
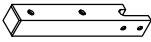
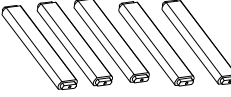
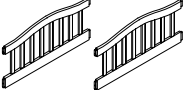



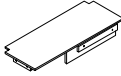
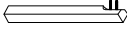
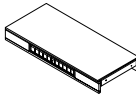











Bolt
1/4" x 5/8"

Exploded View

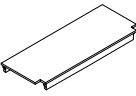
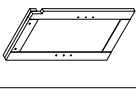
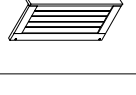

CM-BK265 is packed in 4 cases

Carton	Disignation	Part	Hardware
CM-BK265-1	Left Back Post	#1 	
	Right Back Post	#3 	
	Left Front Post	#2 	
	Right Front Post	#4 	
	Front Rail	#16 	
	Back Rail	#17 	
	Short Guardrail (2pcs)	#19 	
	Long Guardrail (2pcs)	#18 	
	Ladder Rail (Left Side)	#22 	
	Ladder Rail (Right Side)	#23 	
	Guardrail Support (2pcs)	#21 	
	Guardrail Attachment	#20 	
	Ladder Step (5pcs)	#24 	
	Frame HB (2pcs)	#5 	
	Slat (14pcs) 1SET	#25 	

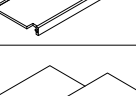
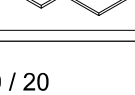
CM-BK265-2	NightStand	#14			
	NightStand Top Panel	#12			
	Leg	#13			
CM-BK265-3	Desk	#15		 #A x 8sets	 #B x 3pcs
				 #C x 2pcs	 #D x 2pcs
				 #E x 24pcs	 #F x 14pcs
				 #G x 10pcs	 #H x 2pcs
				 #I x 34pcs	 #J x 6pcs
				 #K x 8pcs	 #L x 8pcs
				 #M x 2pcs	 #N x 26pcs
				 #O x 2pcs	 #P x 2pcs
				 #Q x 4pcs	 #R x 1pc
				 #S x 1pc	 #T x 2pcs
CM-BK265-4	Right Bookcase Top Panel	#6			
	Right Bookcase Center Panel	#8			
	Right Bookcase Right Panel	#10			
	Right Bookcase Left Panel	#9			
	Right Bookcase Bottom Panel	#7			
	Right Bookcase Shelf Panel(2pcs)	#11			

ASSEMBLY INSTRUCTIONS

1

- Part #1 x1pc
- Part #2 x1pc
- Part #3 x1pc
- Part #4 x1pc
- Part #5 x2pcs
- Hardware #F x8pcs
- Hardware #S x8pcs

Align the HB frames (#5) to the back posts and front posts. Insert bolts (#F) into each end and secure using the Allen wrench (#S).

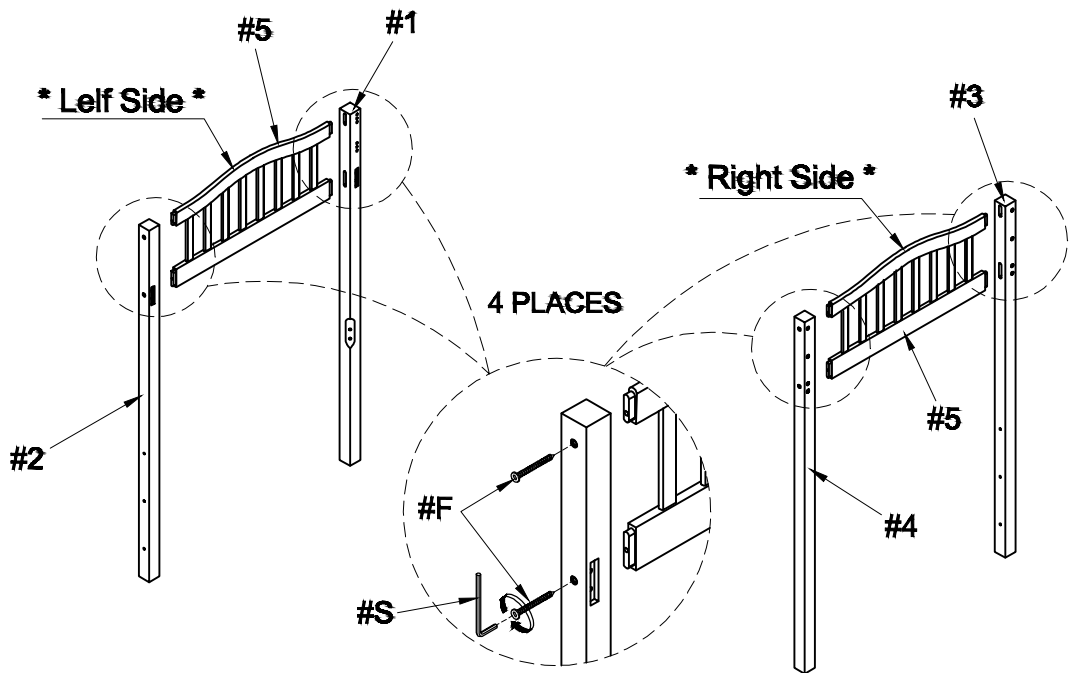

2

- Part #6 x1pc
- Part #7 x1pc
- Part #8 x1pc
- Hardware #E x4pcs
- Hardware #N x2pcs

Align the right bookcase center panel (#8) to the right bookcase top panel (#6) and bottom panel (#7). Insert bolts into the side and bottom pre-drilled holes.

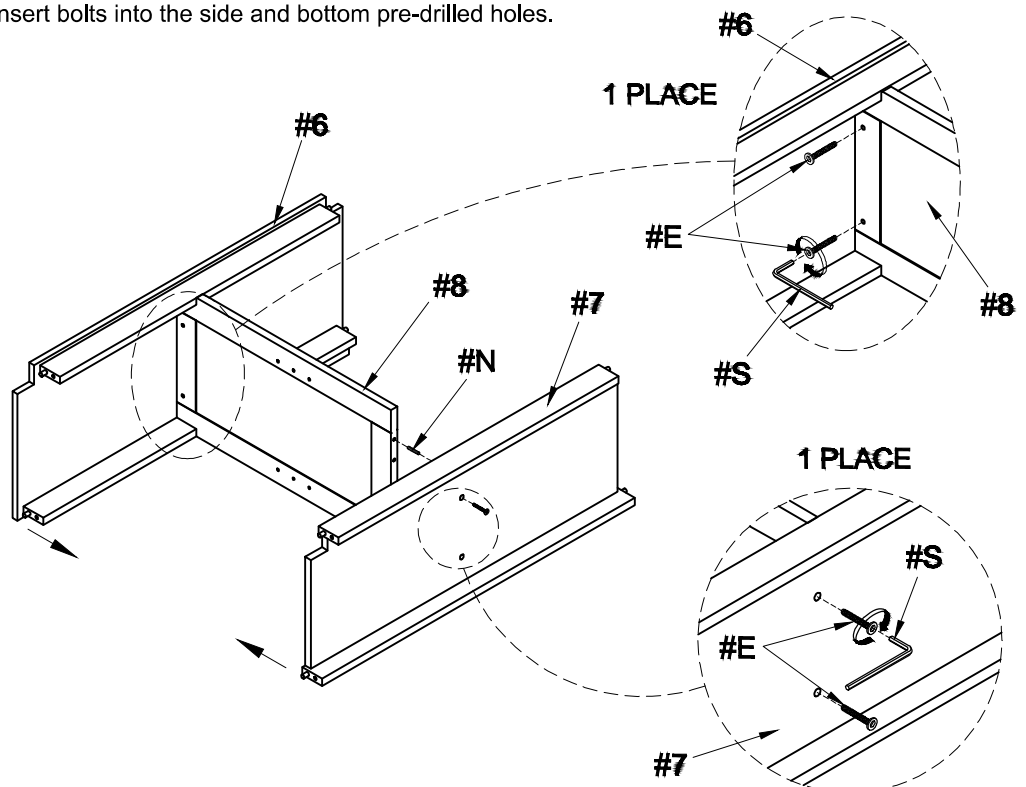

ASSEMBLY INSTRUCTIONS

3

Part #9 x1pc

Part #10 x1pc

Hardware #E x8pcs

Hardware #N x8pcs

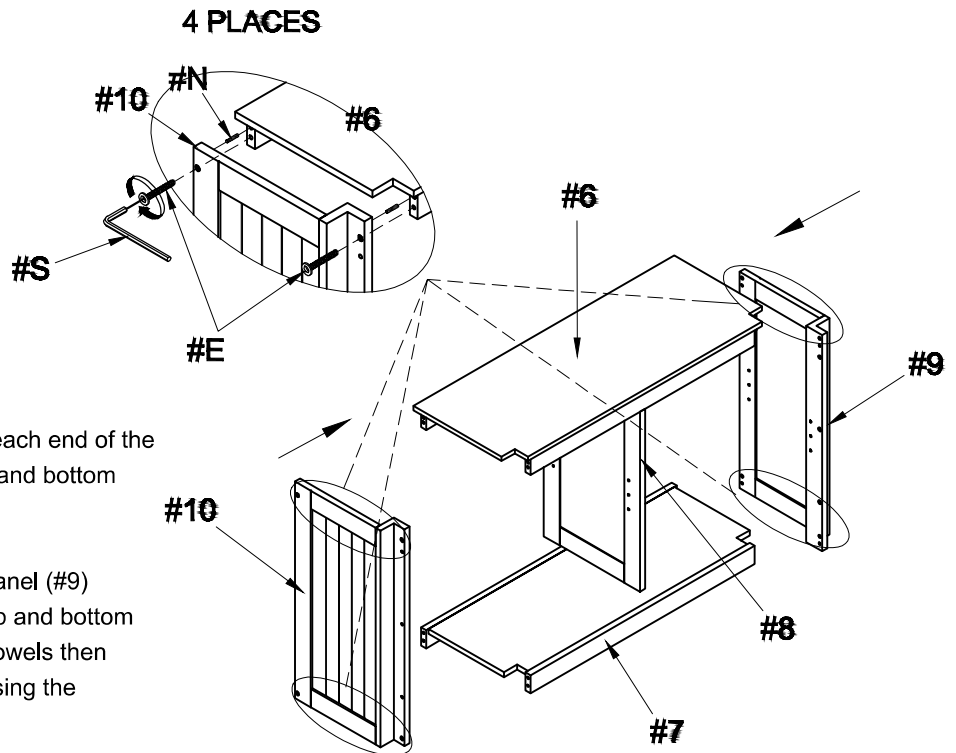

I. Insert wood dowels (#N) into each end of the right bookcase top panel (#6) and bottom panel (#7).

II. Align the right bookcase left panel (#9) and right panel (#10) to the top and bottom panels. Insert into the wood dowels then insert bolts (#E) and secure using the Allen wrench (#S).

4

Part #11 x2pcs

Hardware #K x8pcs

Hardware #L x8pcs

Insert small L connection brackets (#L) into the designated slots along the sides of the panels. Apply right bookcase shelf panels (#11) and insert screws (#K). Secure using a Phillips screwdriver.

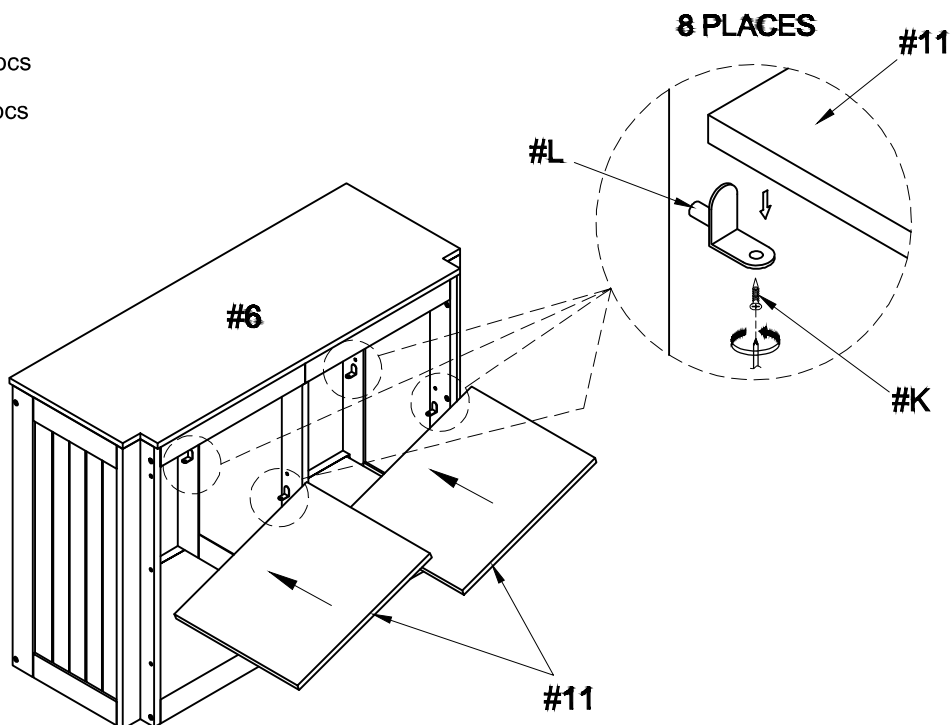

ASSEMBLY INSTRUCTIONS

Align the nightstand top panel (#12) on top of the nightstand (#14).
Insert bolts (#E) and secure using the Allen wrench (#S).

5

- Part #12 x1pc
- Part #14 x1pc
- Hardware #E x2pcs

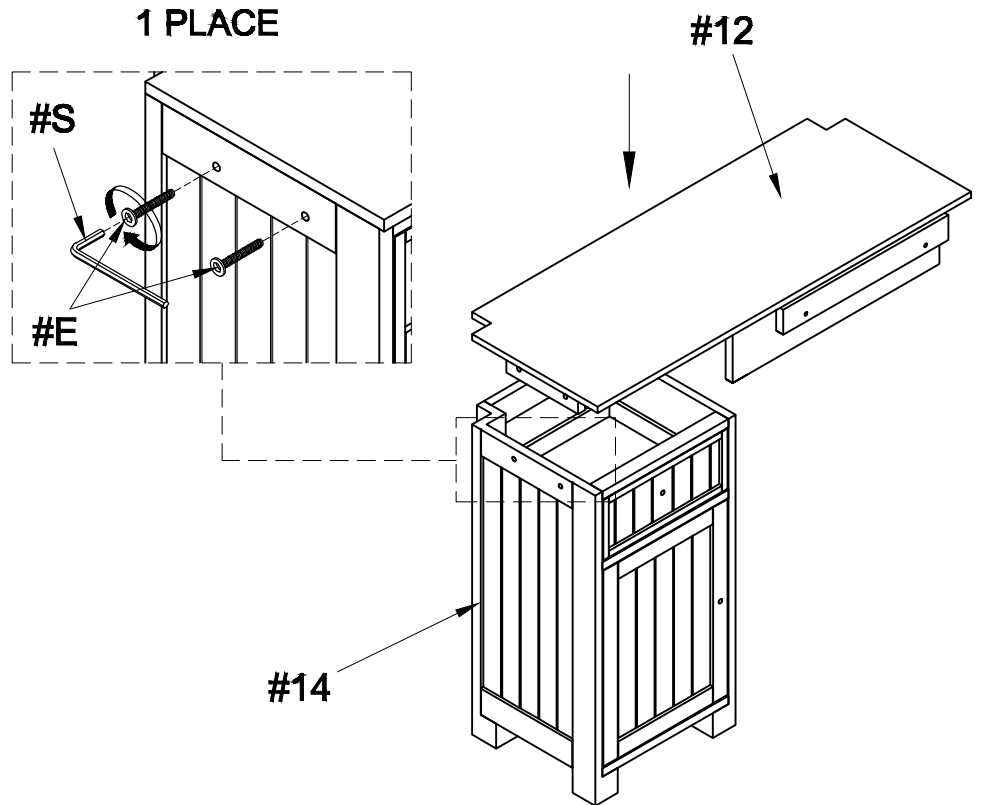

6

- Hardware #J x4pcs
- Hardware #M x2pcs
- Hardware #T x2pcs

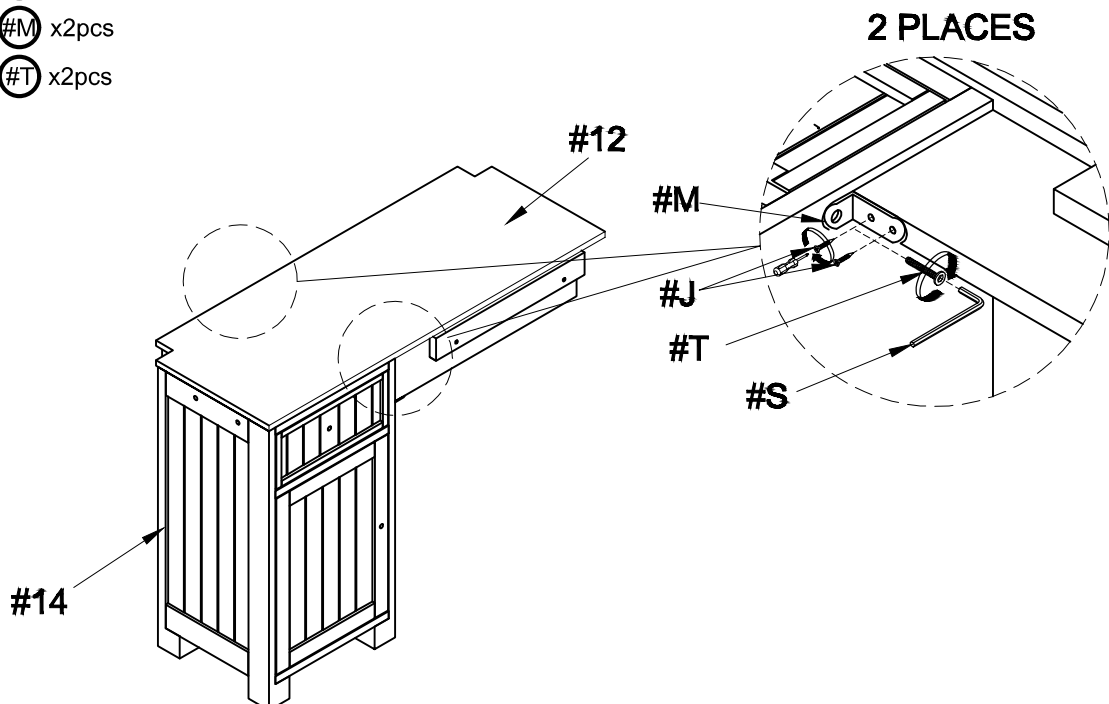

ASSEMBLY INSTRUCTIONS

7

- Part #13 x1pc
- Hardware #O x2pcs
- Hardware #P x2pcs
- Hardware #Q x2pcs

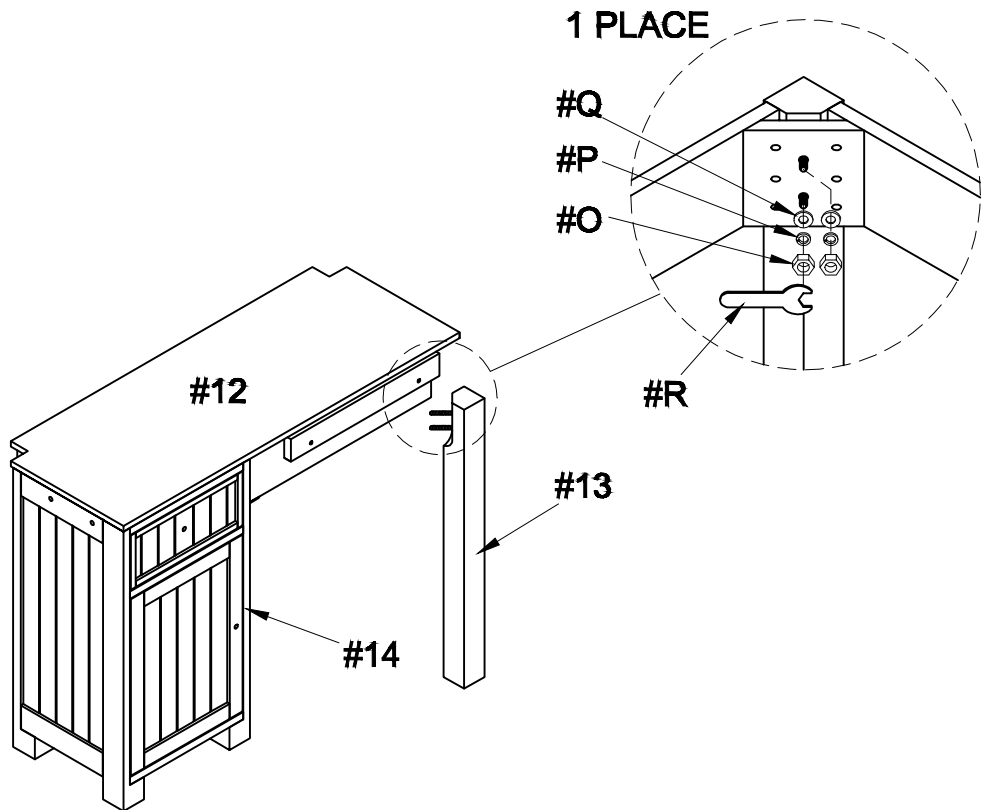

8

- Part #15 x1pc
- Hardware #E x4pcs

Align the desk (#15) to the nightstand top panel (#12) and the right bookcase top panel (#6). Insert bolts (#E) and secure using the Allen wrench (#S).

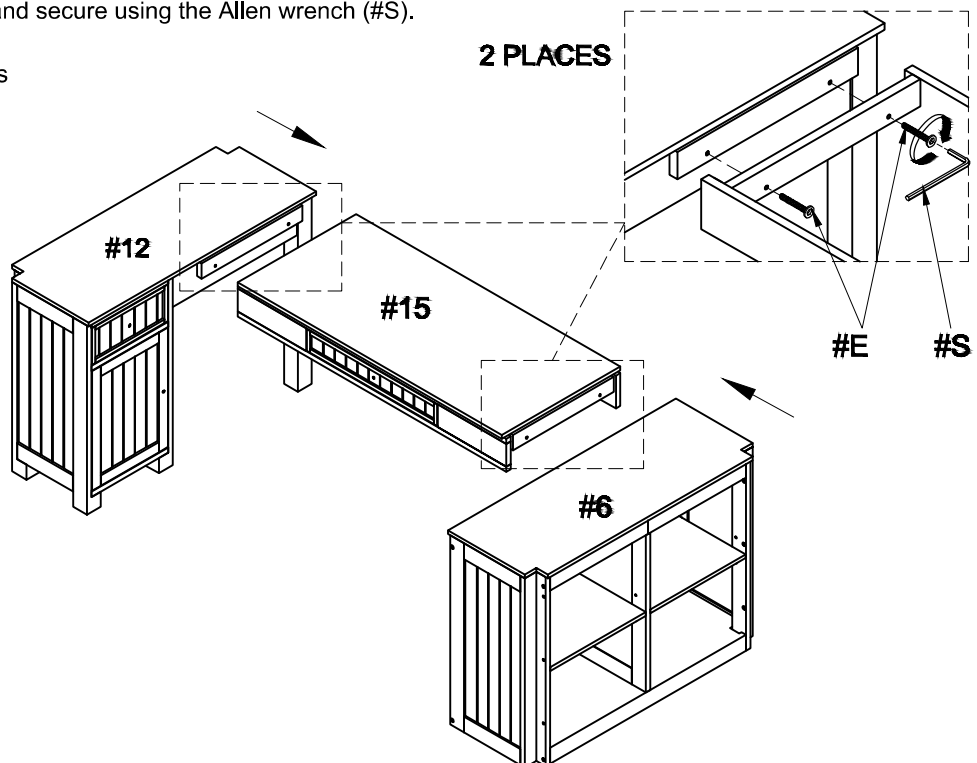

ASSEMBLY INSTRUCTIONS

9

Hardware #B x3pcs

Hardware #C x2pcs

Hardware #Q x2pcs

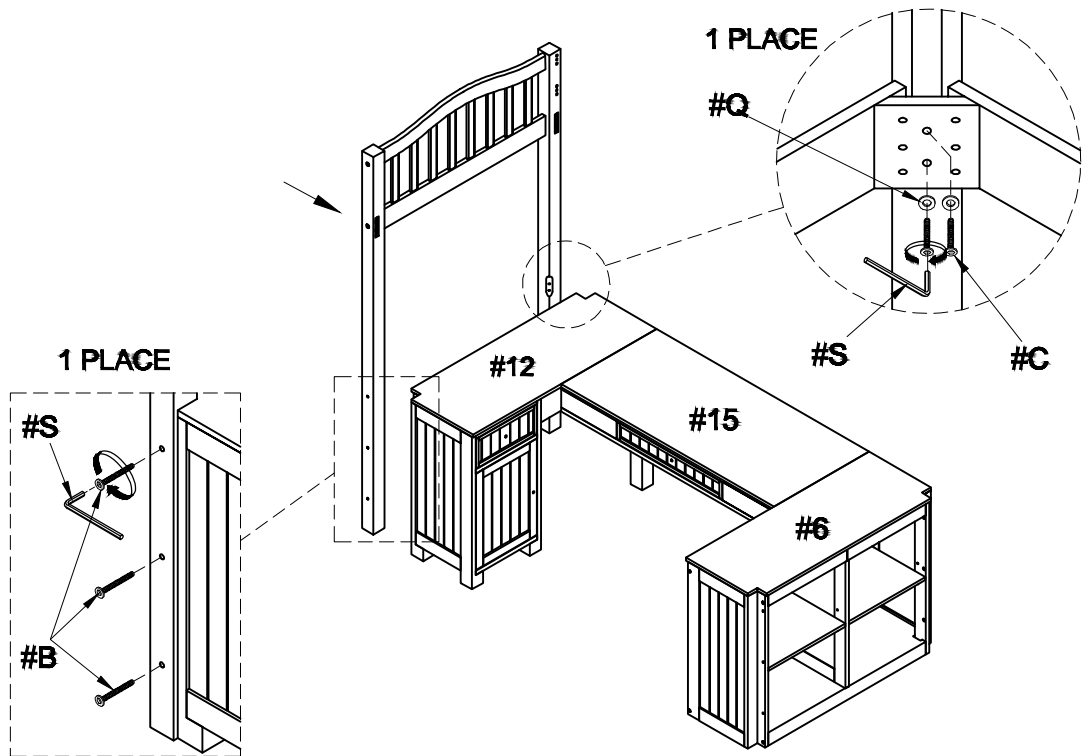

10

Part #16 x1pc

Part #17 x1pc

Part #18 x2pcs

Hardware #A x8sets

Hardware #F x4pcs

Hardware #N x8pcs

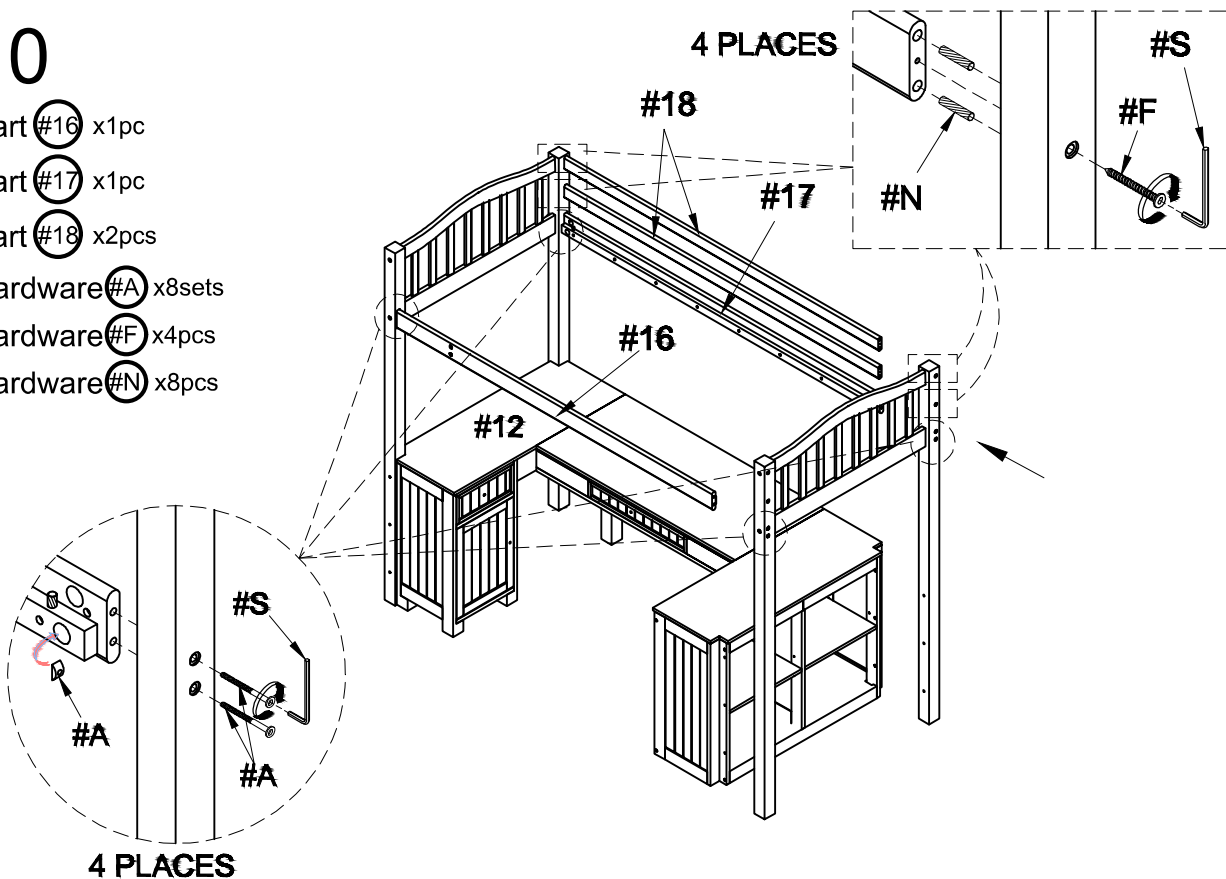

ASSEMBLY INSTRUCTIONS

Align the right back post (#3) to the right bookcase left panel (#9) and right panel (#10). Insert bolts (#E) from within and secure.

11

Hardware #E x6pcs

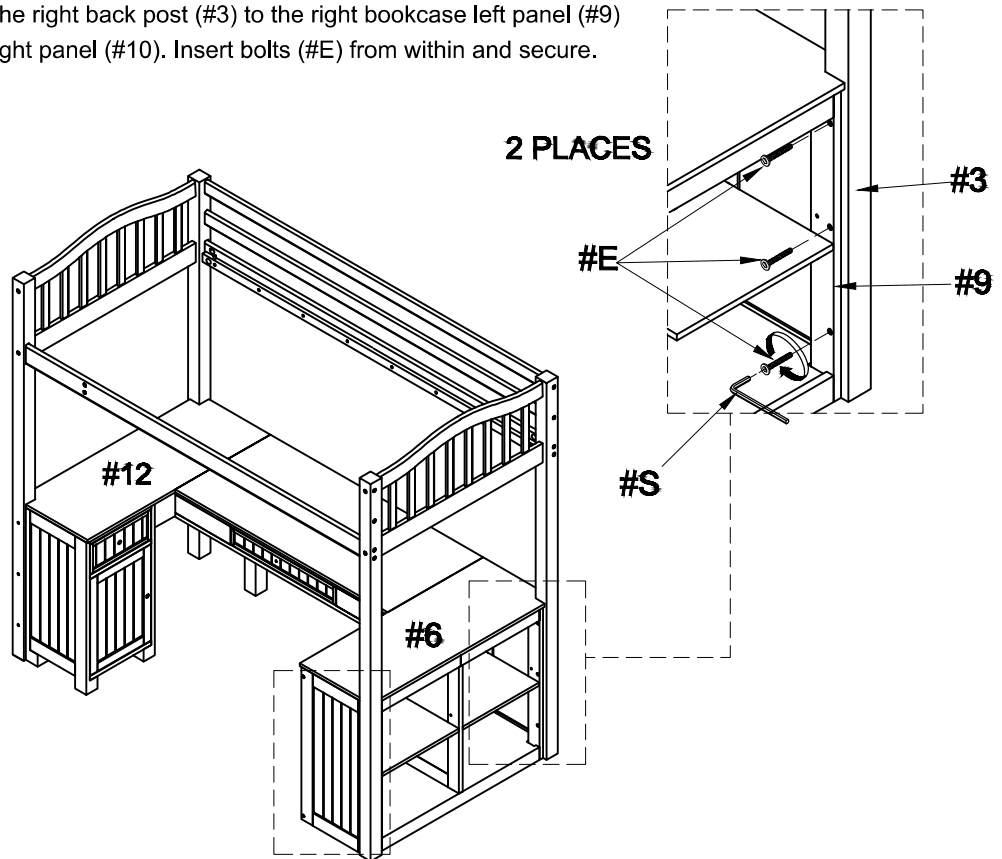

12

Part #19 x2pcs

Part #20 x1pc

Hardware #D x2pcs

Hardware #F x2pcs

Hardware #H x2pcs

Hardware #N x8pcs

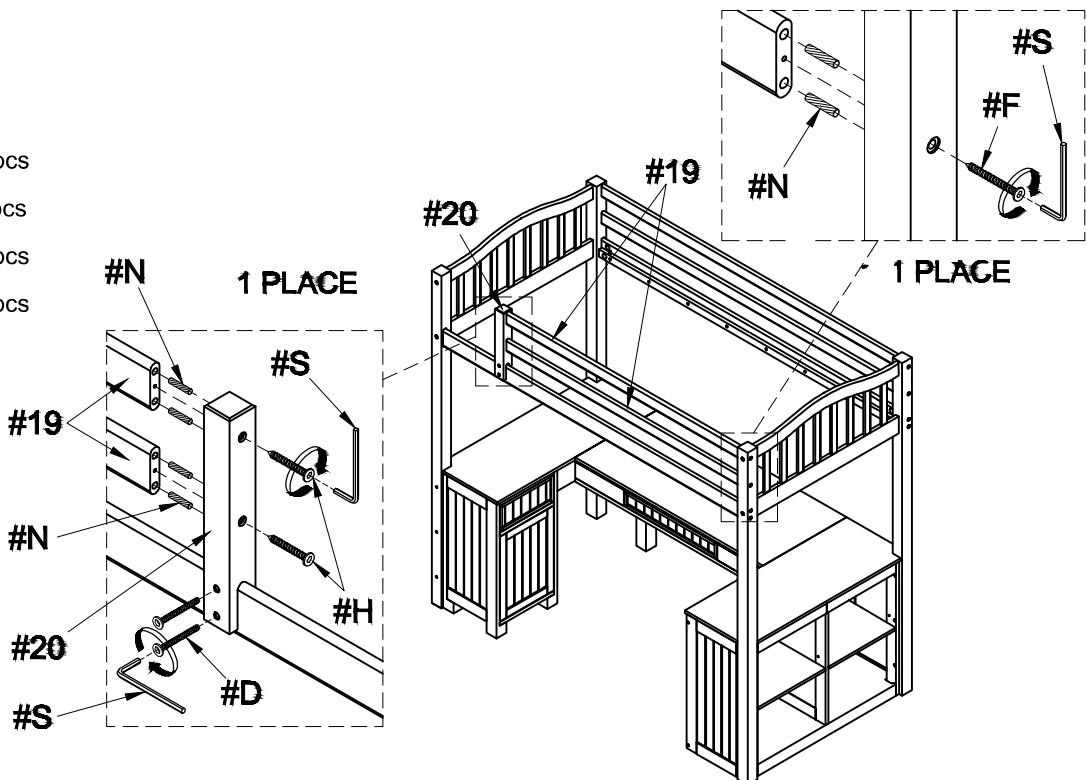

ASSEMBLY INSTRUCTIONS

13

Part #21 x2pcs

Hardware #I x6pcs

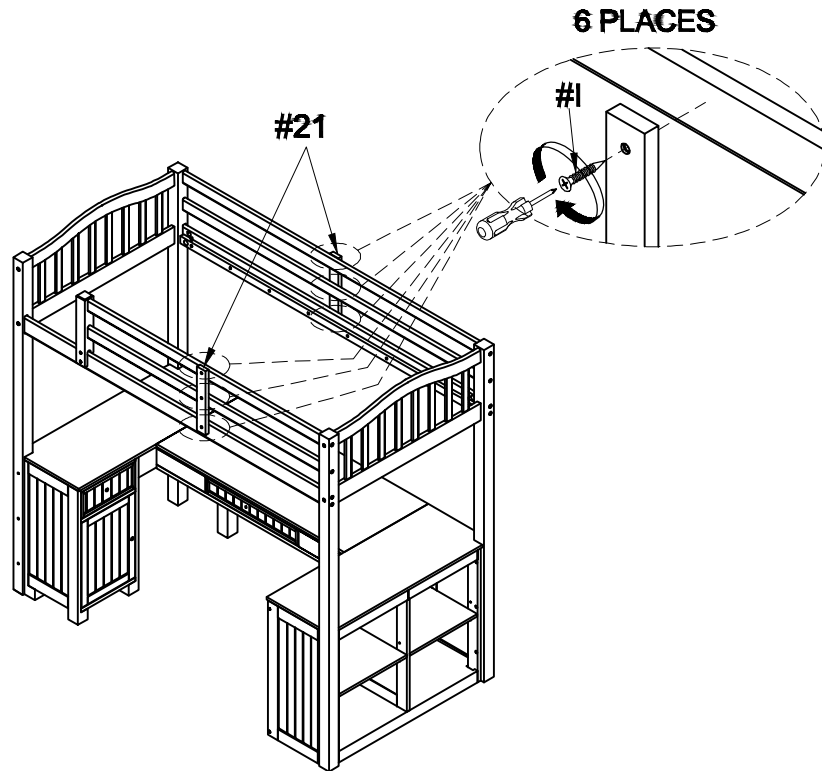

Align the ladder steps (#24) to the ladder rails.
Insert 10 bolts (#G) and secure using the Allen wrench (#S).

14

Part #22 x1pc

Part #23 x1pc

Part #24 x5pcs

Hardware #G x10pcs

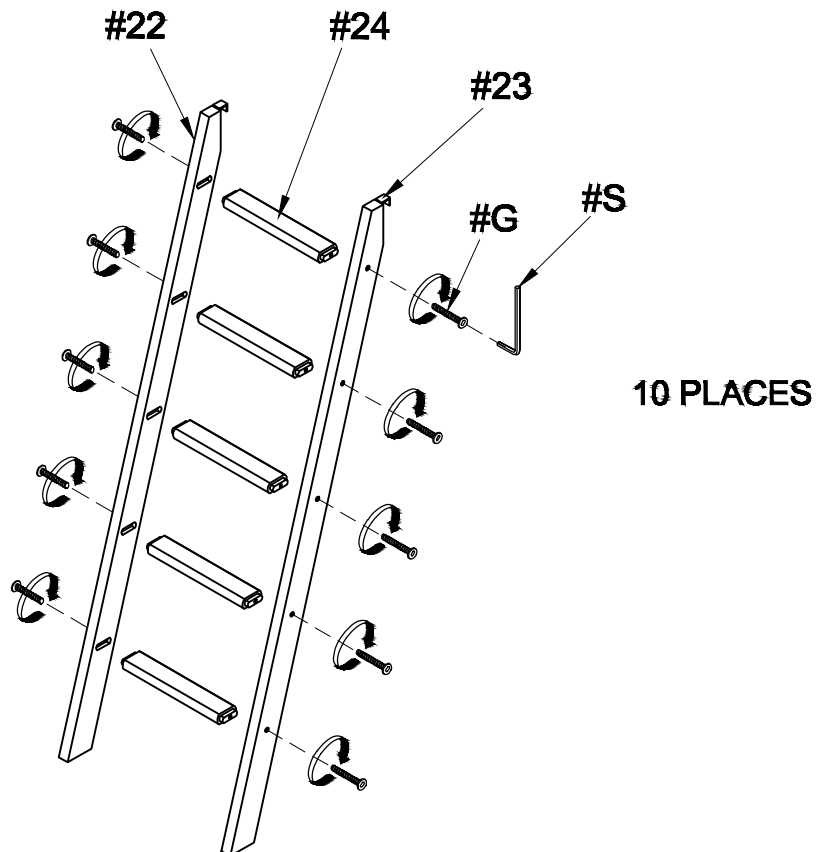

ASSEMBLY INSTRUCTIONS

Hook the ladder and insert 2 screws (#J). Secure using a Phillips screwdriver.

15

Hardware  #J x2pcs

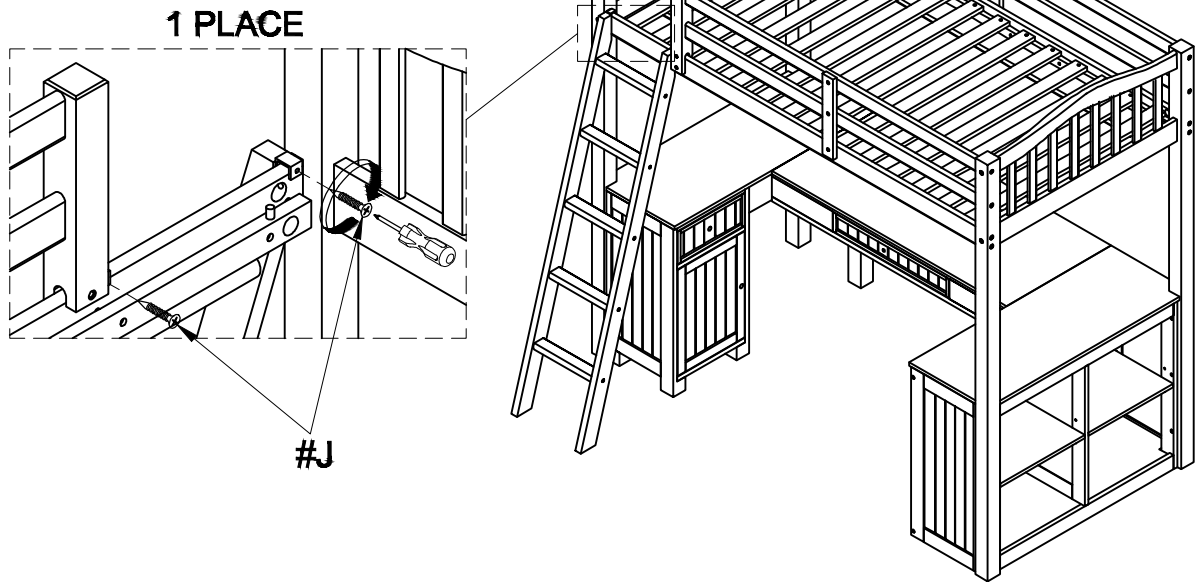

16

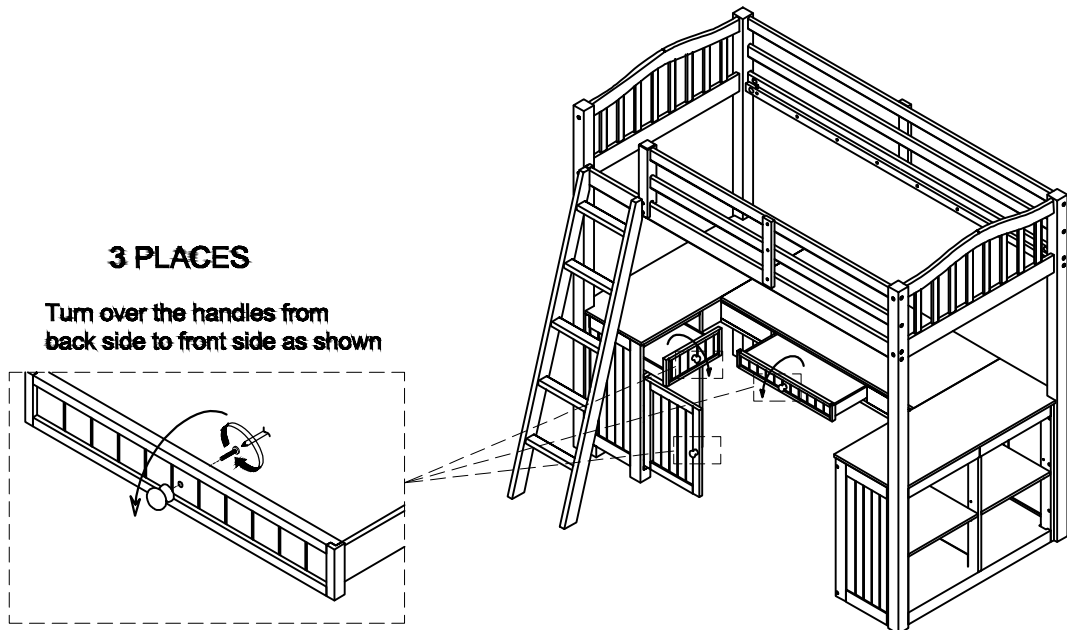

ASSEMBLY INSTRUCTIONS

Insert screws (#1) into the slat ends and secure using the Phillips screwdriver.

28 PLACES

17

Part #25 x1SET

Hardware #1 x28pcs

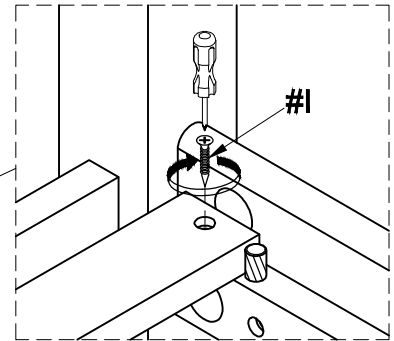
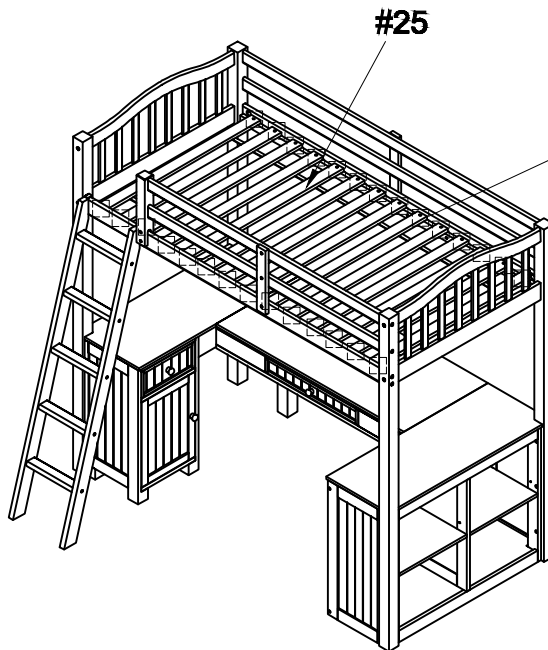

18

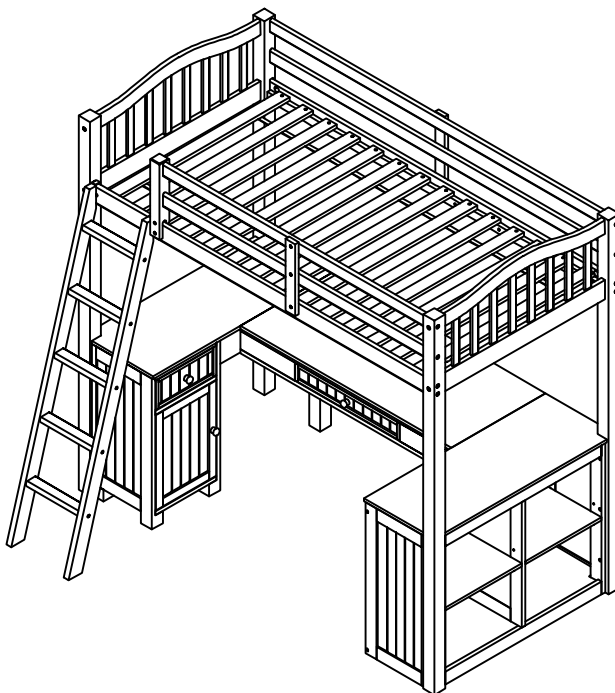

ASSEMBLY COMPLETED



Please ensure the furniture rests on an even and flat surface. If the product wobbles or feels loose, double-check all bolts and/or screws are properly tightened and secured.

✓ **Keep this handy!**

Please retain this instruction manual and any order-related information for future reference.

✓ **Lift, don't drag!**

To avoid damage to product please always LIFT the product when transporting or adjusting the placement.

Safety Warnings for Bunk Beds

1. Read and follow the information on the WARNINGS shown on the end structure of the upper bunk and on the carton.
2. Do not remove warning label from the bed.
3. Keep these instructions for future reference.
4. **IMPORTANT: Must use Bunkie mattress or Bunkie board.** The proper sizes for the **UPPER/LOWER TWIN-SIZE** Bunkie mattress or Bunkie board should be 74" long and 37½" - 38½" wide with no more than 6" thickness and for the **UPPER/LOWER FULL-SIZE** should be 74" long and 53" - 54" wide with no more than 6" thickness.
5. Surface of mattress must be at least 5 inches (127 mm) **BELOW** the upper edge of guardrails.
6. The **MAXIMUM** weight capacity for the upper bunk is not to exceed 175 lbs.
7. Do not allow children under 6 years of age to use the upper bunk.
8. Periodically check and ensure that the guardrails, ladder, handle and other components are in their proper position, free from damage, and that all connectors are tightened and secured.
9. **DO NOT** allow horseplay, rough playing or jumping on the beds and do not allow playing or hiding under the beds.
10. Always use the ladder for entering or leaving the upper bunk.
11. Do not use substitute parts. Contact the manufacturer or dealer for replacement parts.
12. Use of a nightlight may provide added safety precaution for a person using the upper bunk.
13. Always use the guardrails on both sides of the upper bunk.
14. If the bunk bed will be placed next to a wall, the guardrail that runs the full length of the bed should be placed against the wall to prevent entrapment between the bed and the wall.
15. The use of water or sleep flotation mattresses is prohibited.
16. No more than one person is allowed on the upper bunk at all times.



WARNING: STRANGULATION HAZARD

Never attach or hang objects to any part of the bunk bed that are not designed for use with the bed. Objects such as hanger, hook, belt, bag, rope, string, etc. should not be used on or around the bunk bed.