

# ASSEMBLY INSTRUCTIONS

**WARNING!** This unit must be assembled in the order shown. Failure to do so may result in damage to the parts or impede function of the unit.

## General Instructions

- Read all Assembly Instructions prior to assembling the product
  - Make sure you have all parts before beginning assembly
- To avoid damage, assemble the product on a non-abrasive surface.

**STEP 1:** To install “easy-off chair back”, slide inside back receivers (1) onto the steel mechanism posts (2) in the base of the furniture (Figure A).

**STEP 2:** Press both sides seat back from the top downward firmly into place. The inside back automatically locks into place.

**STEP 3:** To remove the backs, use a screwdriver pulling outward on the black tab in the metal sleeve (Figure B) on both sides of the inside back receivers (1) and lift the back off the base of the furniture.

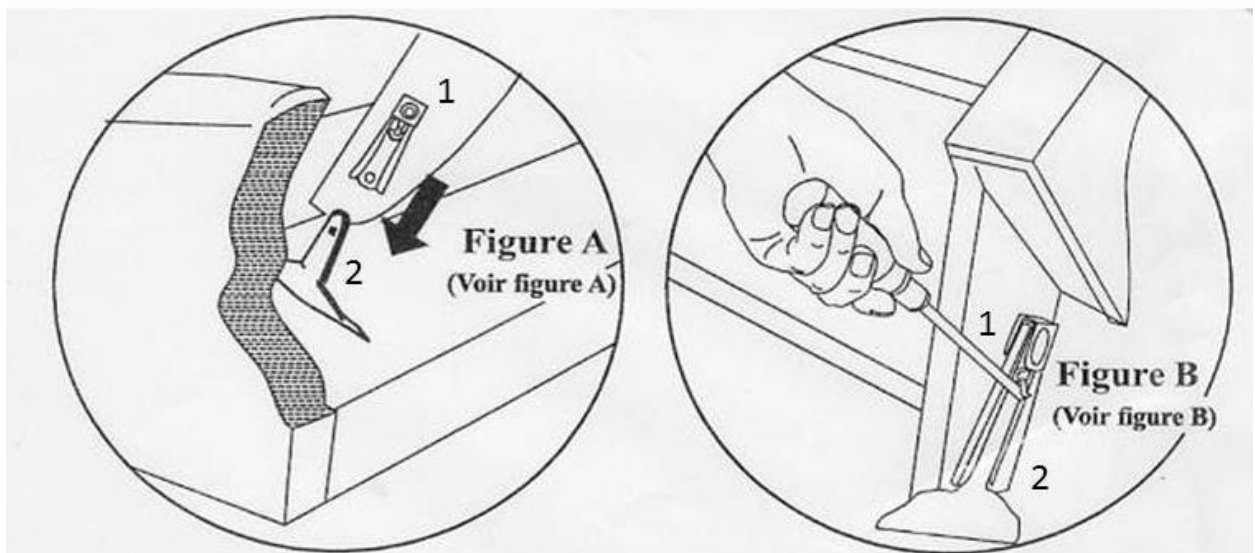

**STEP 4:** Pull down velcro seat back flap and align properly to wrap over the bottom of the base frame and attach/secure. Note: If the seat back is not properly seated on the posts, the velcro back flap will not attach easily.

# 1 Motor: Power Reclining Button

Press one side of button to open power reclining mechanism other side to close

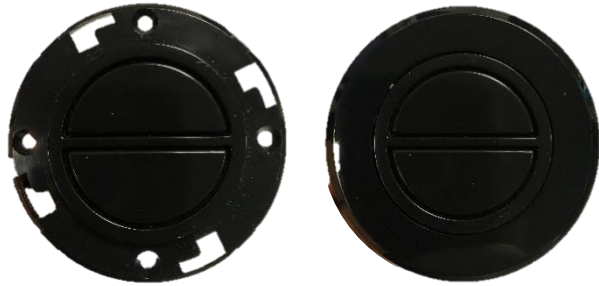

Transformer: Plugs into wall outlet

Reclining Motor



Extension Cable

Single Button Control  
(PICTURE MAY NOT REPRESENT LATEST BUTTON)

# How to Connect the Cables

2 Pin Connector



5 Pin Connector



8 Pin Connector



# 2 Motor: Power Reclining Button

Press one side of button to open power reclining mechanism other side to close  
(THIS REQUIRES 2 SINGLE BUTTON CONTROLS AND A Y - CABLE)

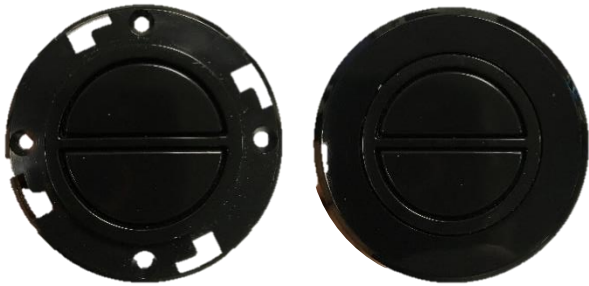

Single Button Control  
(PICTURE MAY NOT REPRESENT LATEST BUTTON)

Reclining Motor

Extension Cable

Reclining Motor

Y-Cable for 2 Motor Configuration

Transformer: Plugs into wall outlet

Single Button Control

(PICTURE MAY NOT REPRESENT LATEST BUTTON)



# How to Connect the Cables

2 Pin Connector



5 Pin Connector



8 Pin Connector



# 1 Motor: Power Reclining Button w/USB

Press one side of button to open power reclining mechanism other side to close

When the button is pushed the Blue light will come on

USB is for charging only, Max 2000 mA/5V

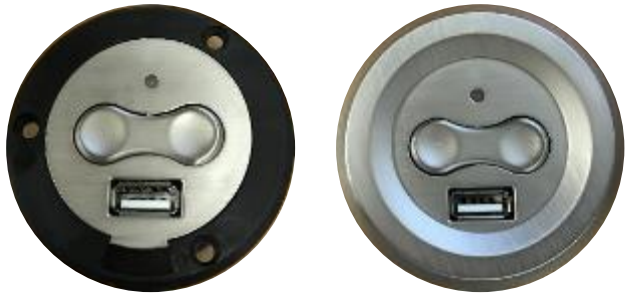

Transformer: Plugs into wall outlet

Reclining Motor



Extension Cable

Single Button Control

# How to Connect the Cables

2 Pin Connector



5 Pin Connector



8 Pin Connector



# 2 Motor: Power Reclining Button w/USB

Press one side of button to open power reclining mechanism other side to close

When the button is pushed the Blue light will come on

USB is for charging only, Max 2000 mA/5V

(THIS REQUIRES 2 SINGLE BUTTON CONTROLS AND A Y – CABLE)

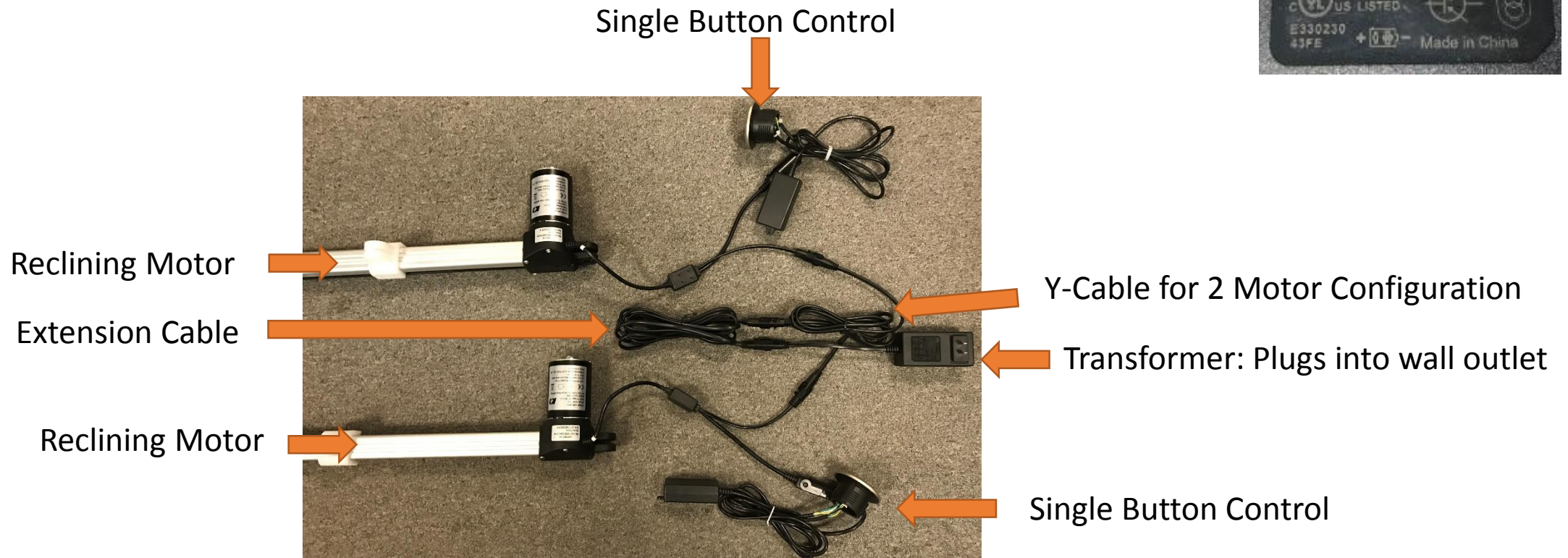
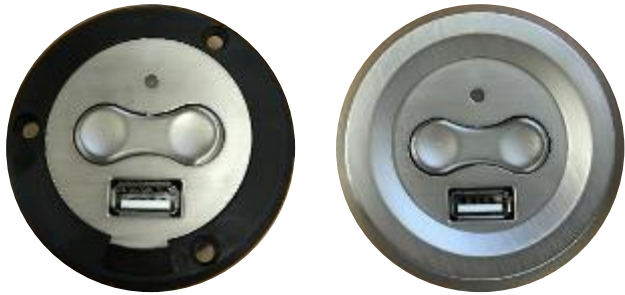

# How to Connect the Cables

2 Pin Connector



5 Pin Connector



8 Pin Connector



# 2 Motor: Power Reclining, Head Tilt w/USB

Button with no dimple : One side will tilt Headrest out the other will close

Button with dimple : Smooth side will open the Ottoman

Dimple side will return all to home position

When the button is pushed the Blue light will come on

USB is for charging only – Max 2000mA/5V



2 Button Controller w/USB



Reclining Motor

Head Tilt Motor

Transformer: Plugs into wall outlet

Extension Cable

5 Pin Plug for Reclining Motor

5 Pin w/Red Tape for Head Tilt

# How to Connect the Cables

2 Pin Connector



5 Pin Connector



8 Pin Connector



# 3 Motor:

## Power Reclining, Head Tilt, Lumbar w/USB

Top Button : Opens and Closes Head Tilt

Middle Button : Opens and Closes Lumbar

Bottom Button: Smooth side will open the Ottoman

Dimple side will return all to home position

When the button is pushed the Blue light will come on

USB is for charging only – Max 2000mA/5V

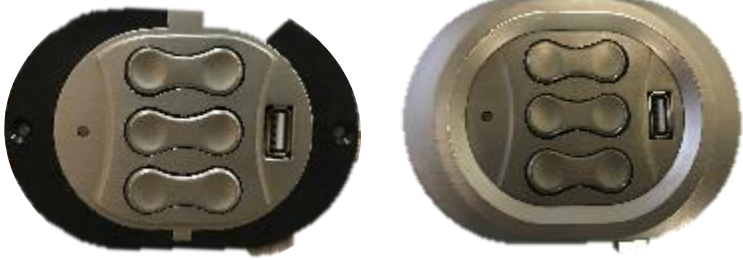

Head Tilt Motor

Lumbar Motor

Reclining Motor

3 Button Controller cable:

- 1 – 8 Pin Connector
  - To Control
- 2 – 2 Pin Connector :
  - 1 w/Yellow Tap for Head Tilt
  - 1 with out for Lumbar)
- 1 – 5 Pin Connector
  - To Reclining Motor

3 Button Controller w/USB

Extension Cable

Transformer: Plugs into wall outlet

# How to Connect the Cables

2 Pin Connector



5 Pin Connector



8 Pin Connector



# 399-04-05-87

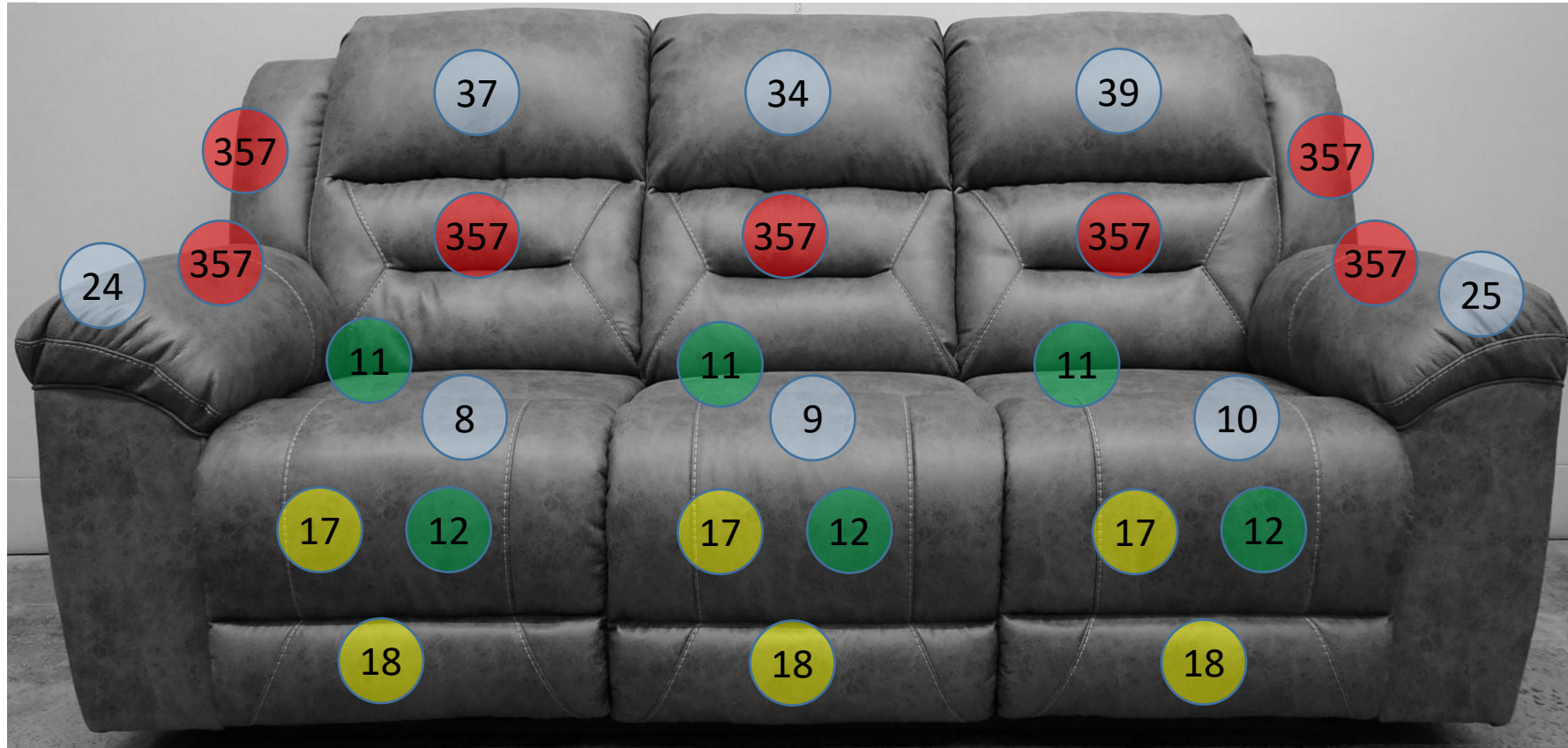

Call Out	Description
● (Red)	Blown Fiber
● (Yellow)	Cushion Chaise Pad - top Pad
● (Green)	Cushion Foam
● (Yellow)	KD Component
● (Blue)	Cover

For more RPs' information, please see the following page.



216



217



425

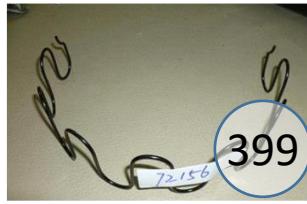

399

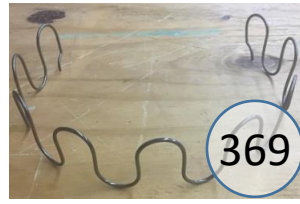

369



419



108



365



444



149



426

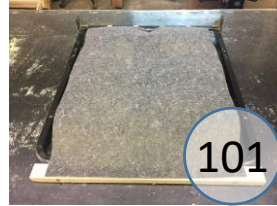

101



102



157



145

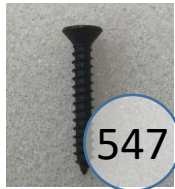

547



105



134



147



440



520

# 399-04-05-96

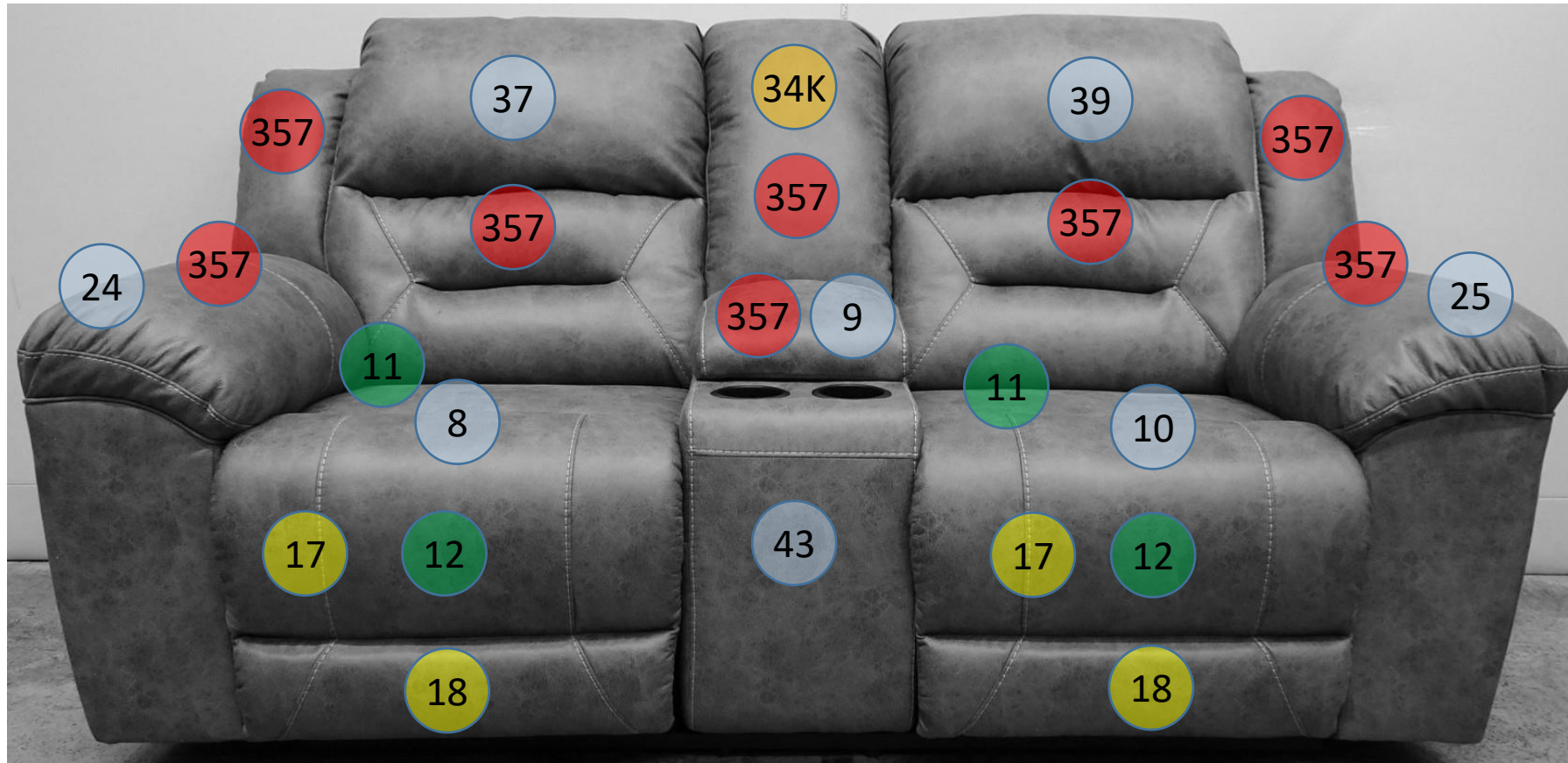

Call Out	Description
● (Red)	Blown Fiber
● (Yellow)	Cushion Chaise Pad - top Pad
● (Green)	Cushion Foam
● (Yellow)	KD Component
● (Blue)	Cover

For more RPs' information, please see the following page.

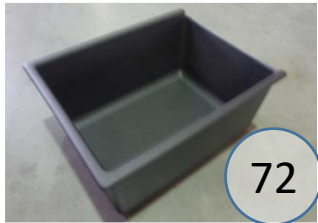
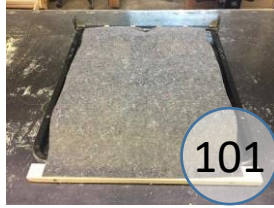
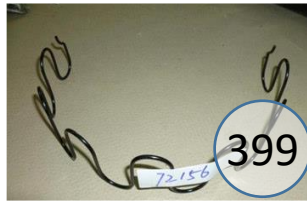

# 399-04-05-94

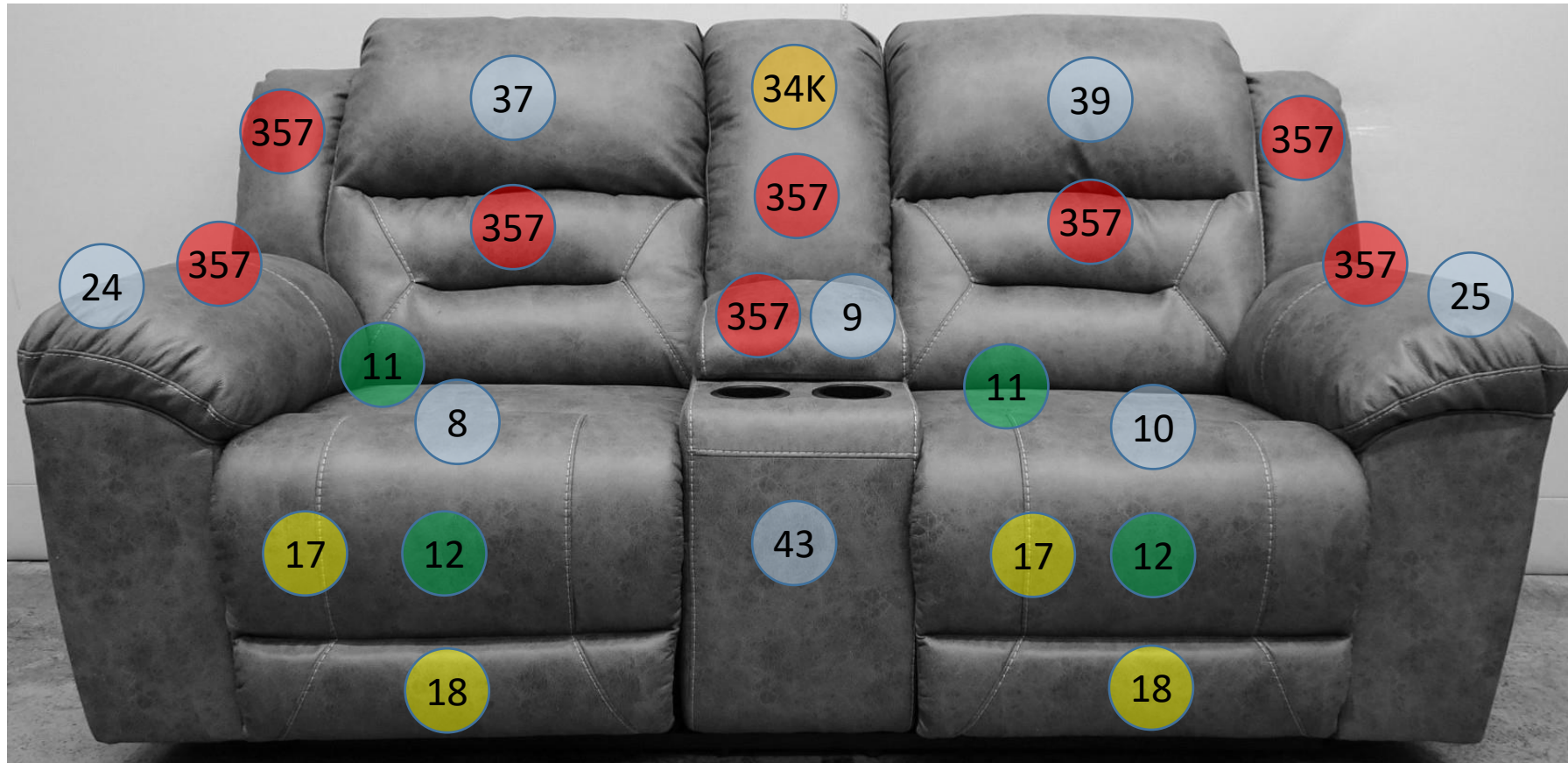

Call Out	Description
● (Red)	Blown Fiber
● (Yellow)	Cushion Chaise Pad - top Pad
● (Green)	Cushion Foam
● (Yellow)	KD Component
● (Blue)	Cover

For more RPs' information, please see the following page.

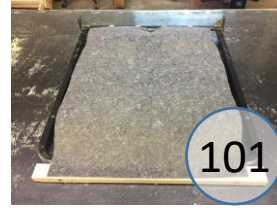
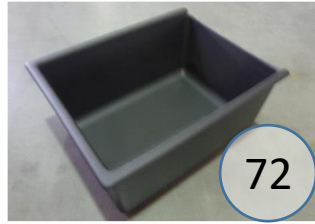
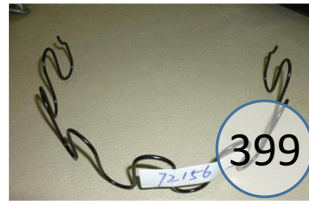

# 399-04-05-98

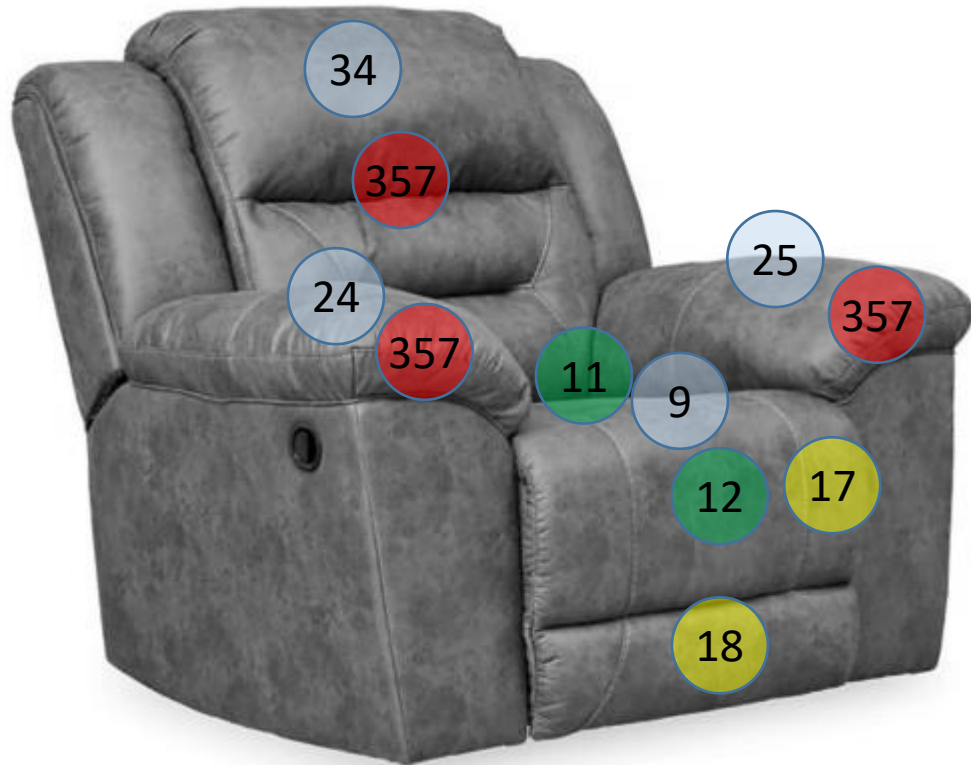

Call Out	Description
●	Blown Fiber
●	Cushion Chaise Pad - top Pad
●	Cushion Foam
●	KD Component
●	Cover

*Signature*  
DESIGN  
BY **ASHLEY**®

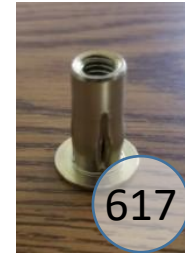
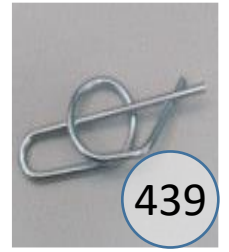
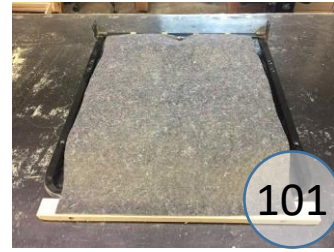

# Replaceable Parts

101

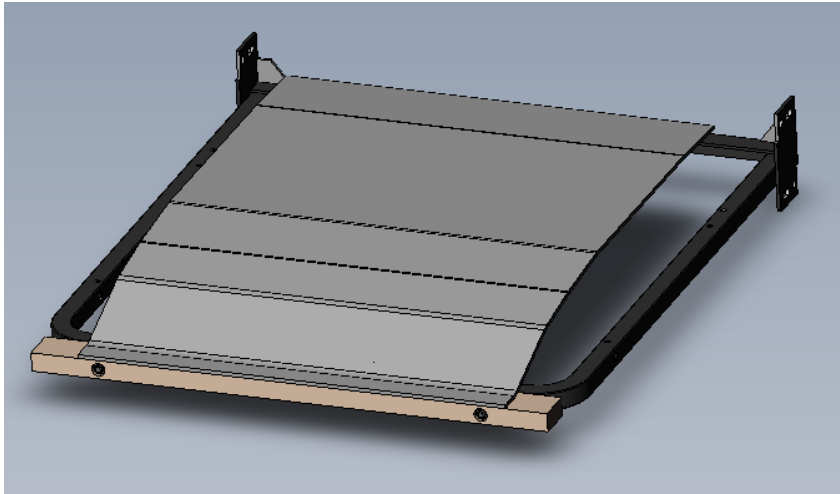

105

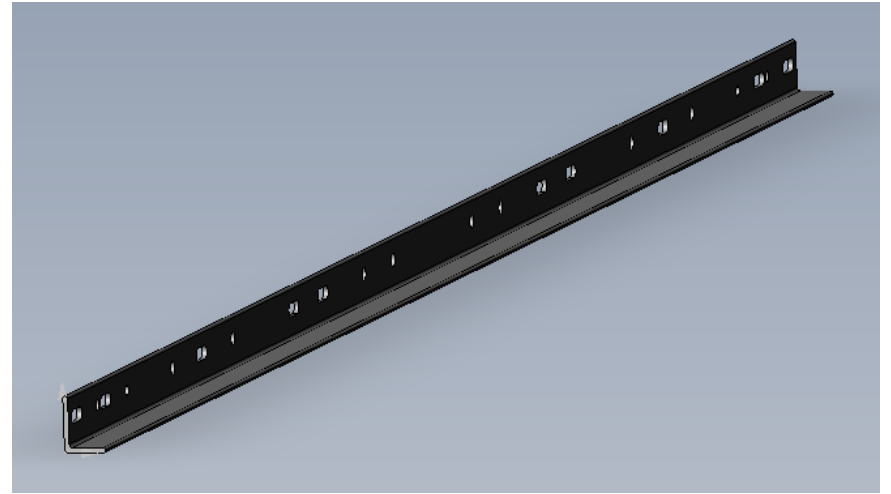

134

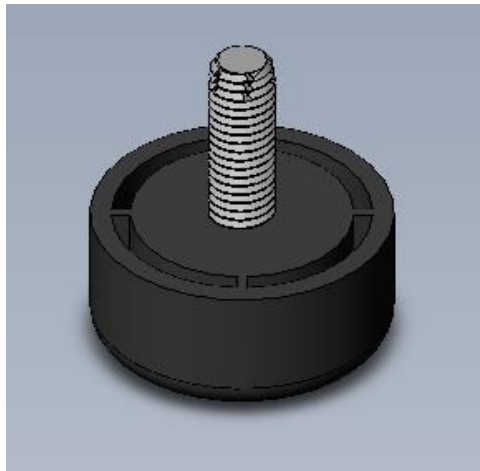

# Replaceable Parts

145

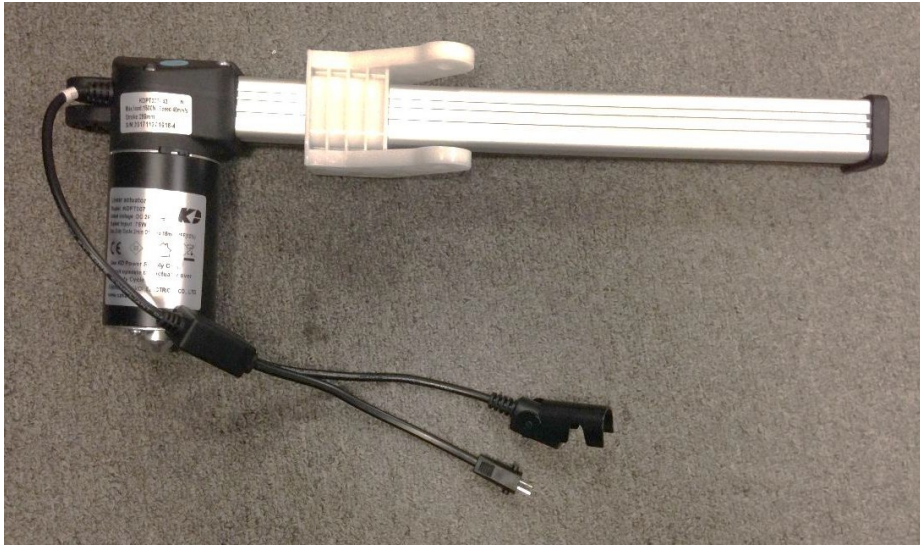

406



157



# Replaceable Parts

