

ASSEMBLY INSTRUCTIONS

WARNING! This unit must be assembled in the order shown. Failure to do so may result in damage to the parts or impede function of the unit.

General Instructions

- Read all Assembly Instructions prior to assembling the product
 - Make sure you have all parts before beginning assembly
- To avoid damage, assemble the product on a non-abrasive surface.

STEP 1: To install “easy-off chair back”, slide inside back receivers (1) onto the steel mechanism posts (2) in the base of the furniture (Figure A).

STEP 2: Press both sides seat back from the top downward firmly into place. The inside back automatically locks into place.



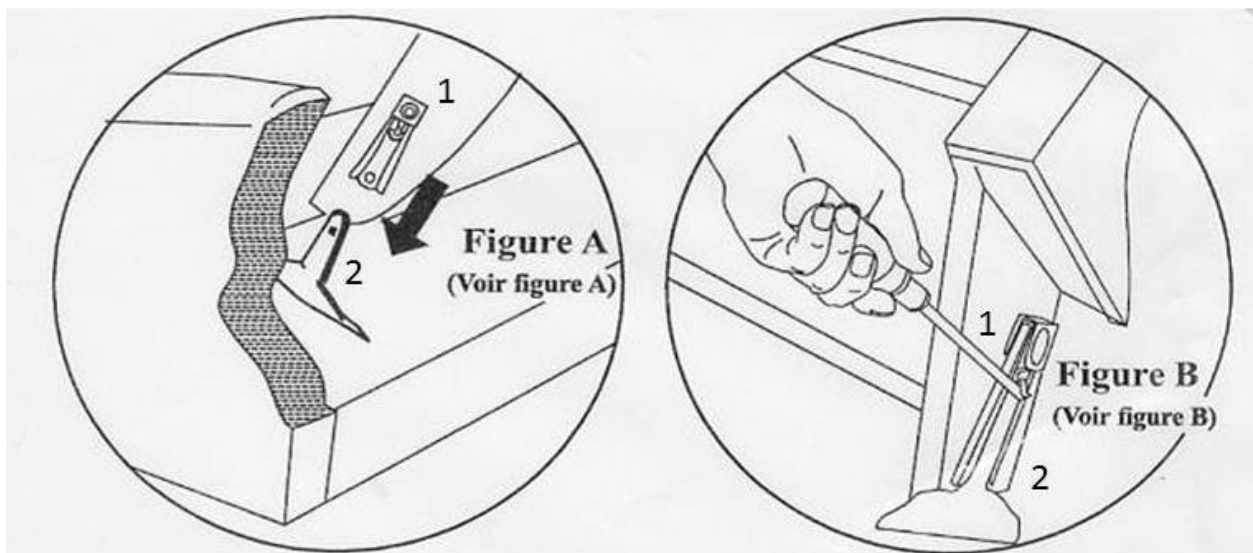

STEP 3: To remove the backs, use a screwdriver pulling outward on the black tab in the metal sleeve (Figure B) on both sides of the inside back receivers (1) and lift the back off the base of the furniture.

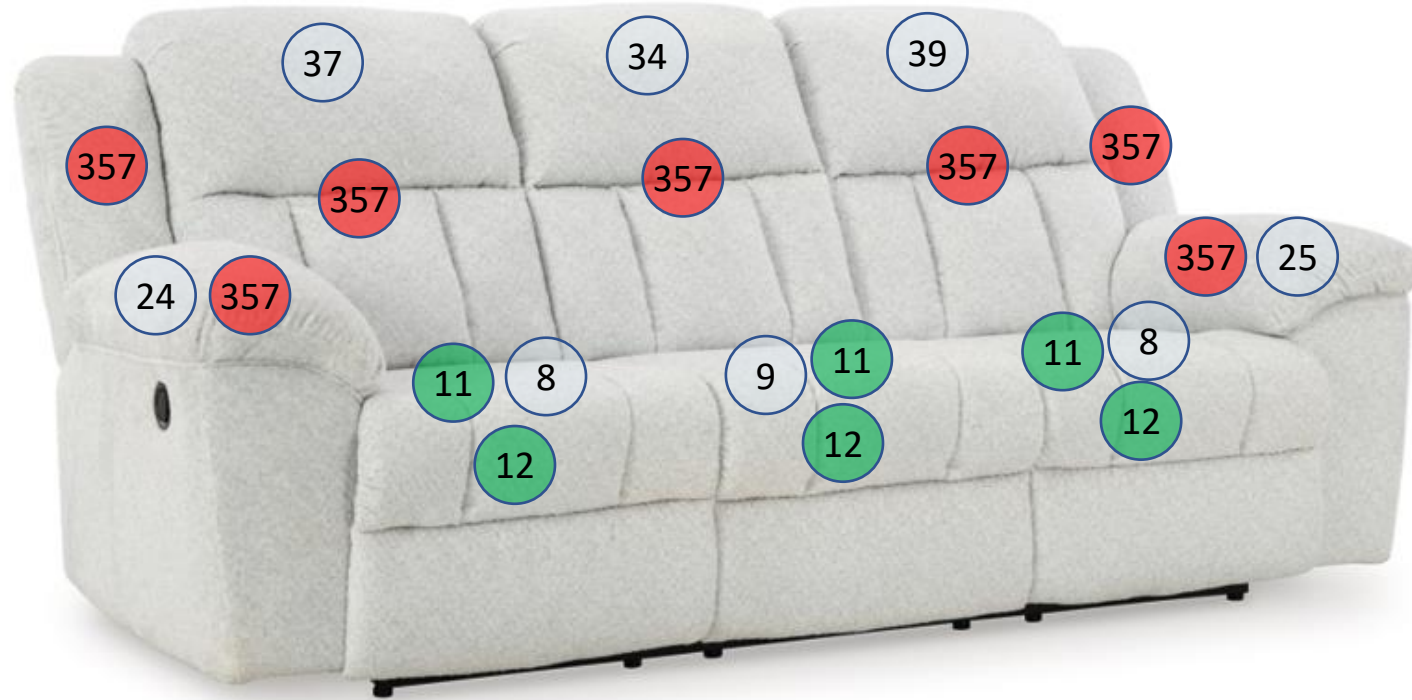

STEP 4: Pull down velcro seat back flap and align properly to wrap over the bottom of the base frame and attach/secure. Note: If the seat back is not properly seated on the posts, the velcro back flap will not attach easily.

3740588



Call out	Description
	Blown Fiber
	Cushion Chaise Pad – Top Pad
	Cushion Foam
	KD Component
	Cover



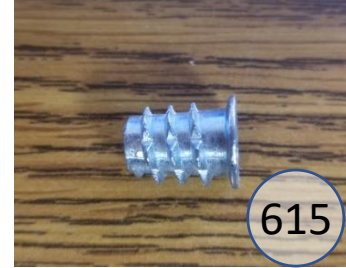

For more RPs' information, please see the following page.



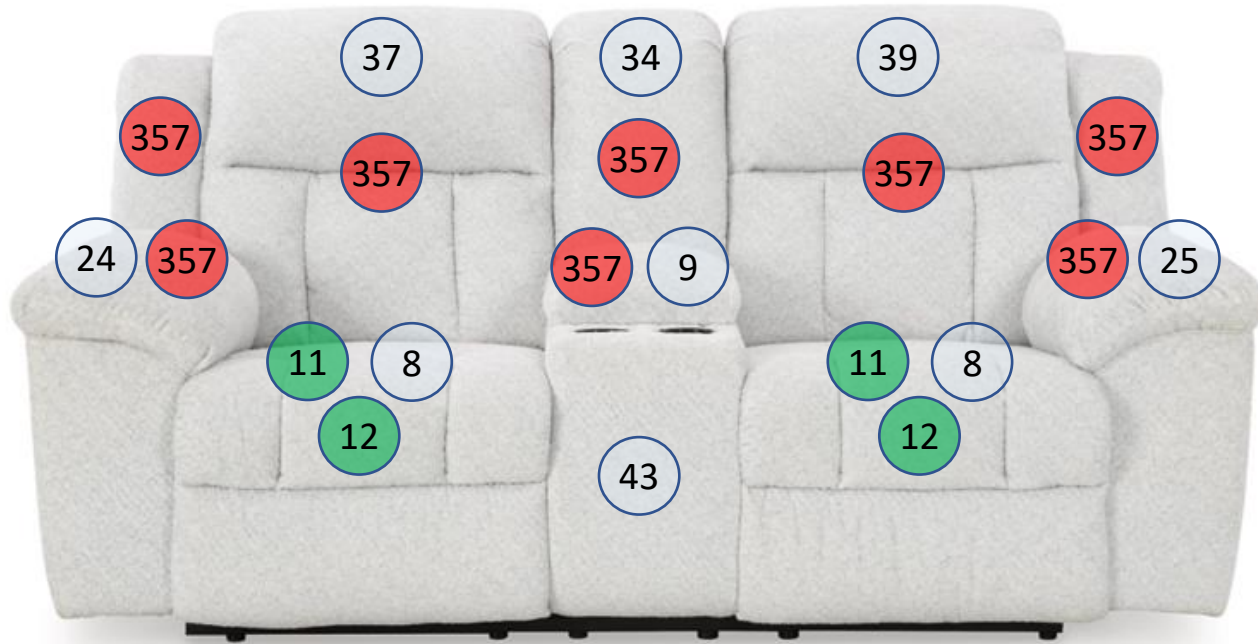

3740594



Call out	Description
	Blown Fiber
	Cushion Chaise Pad – Top Pad
	Cushion Foam
	KD Component
	Cover

For more RPs' information, please see the following page.



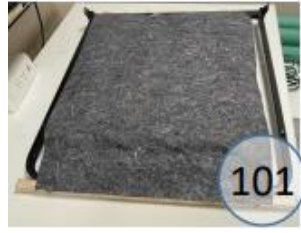

101

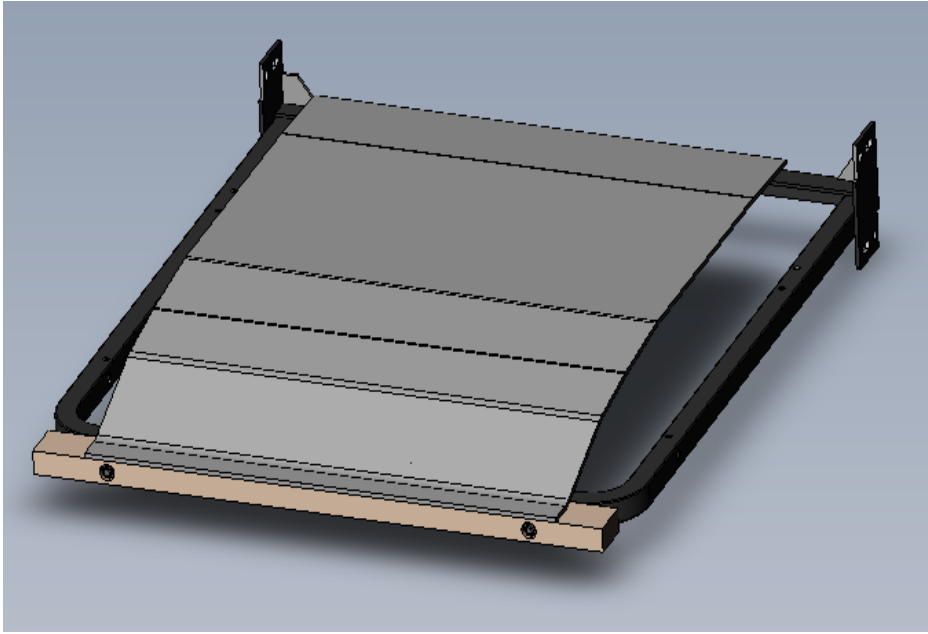

105

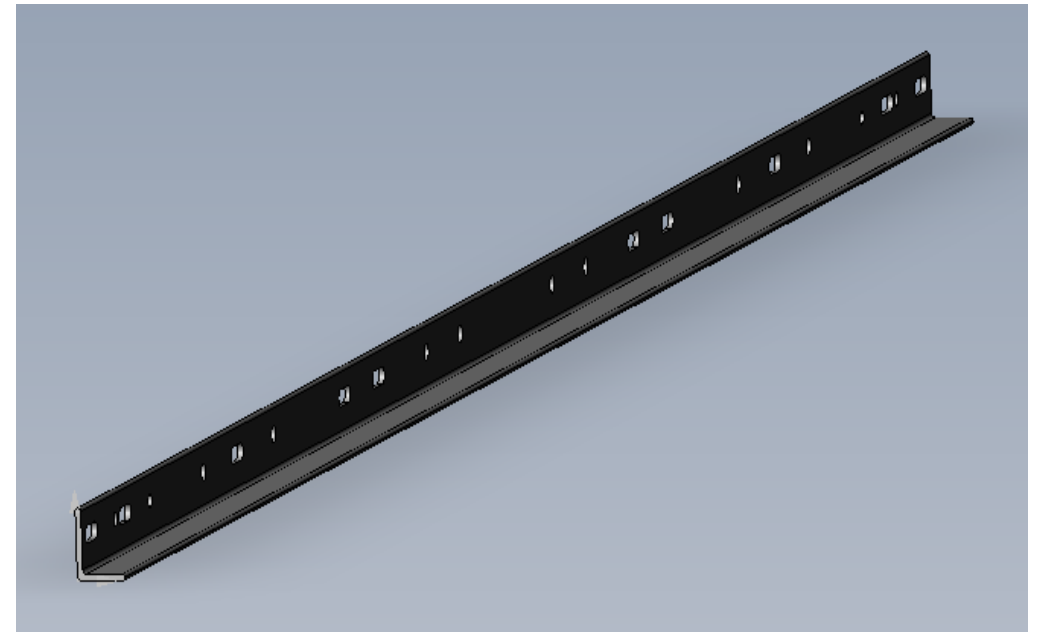



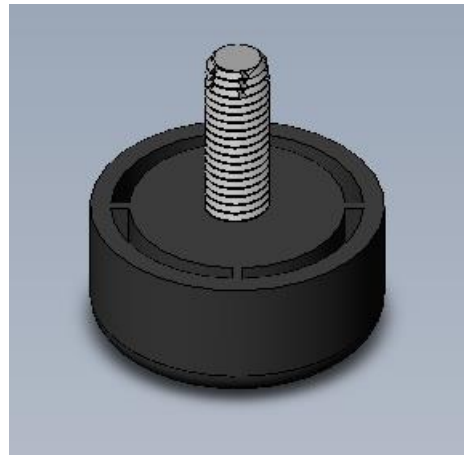

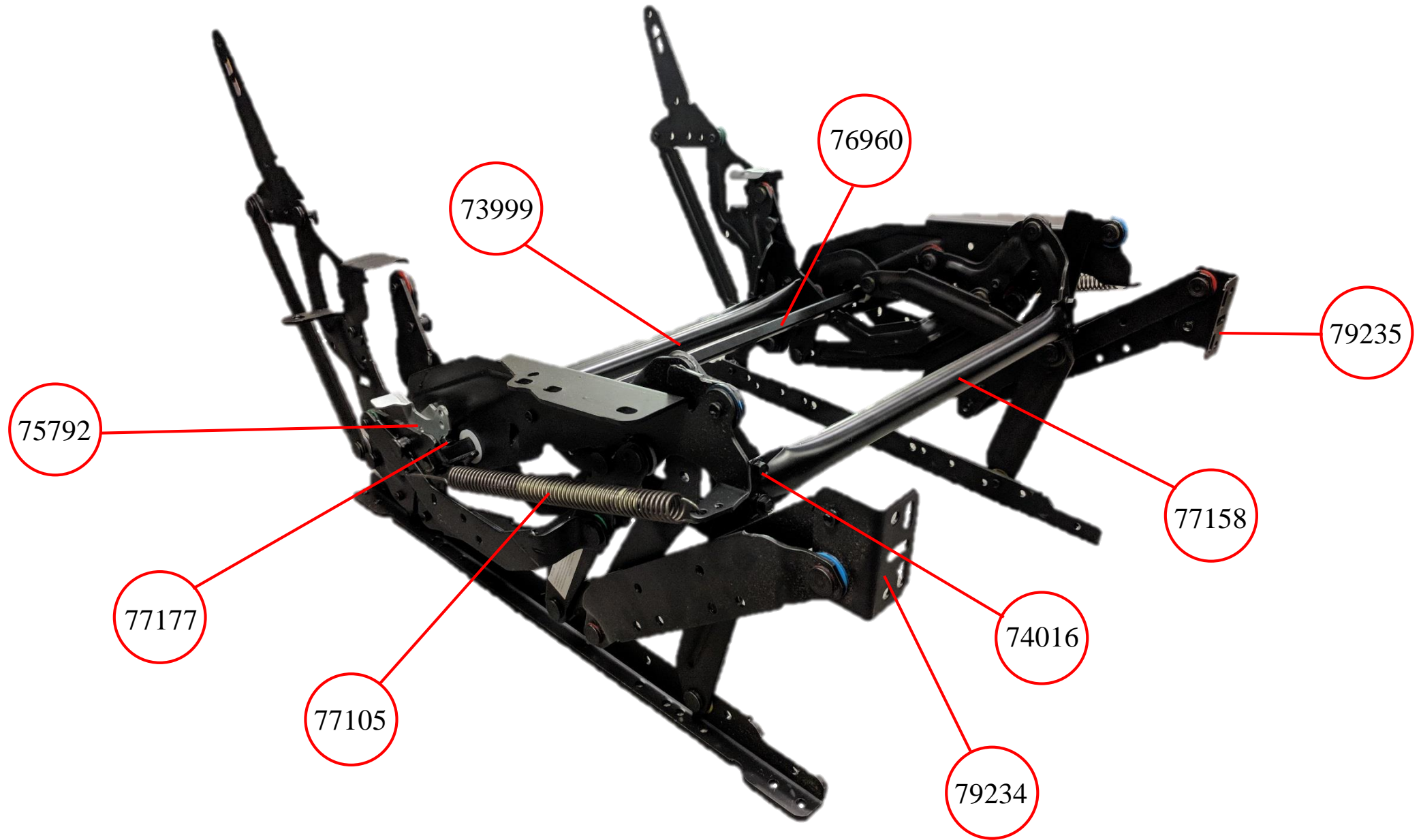

134

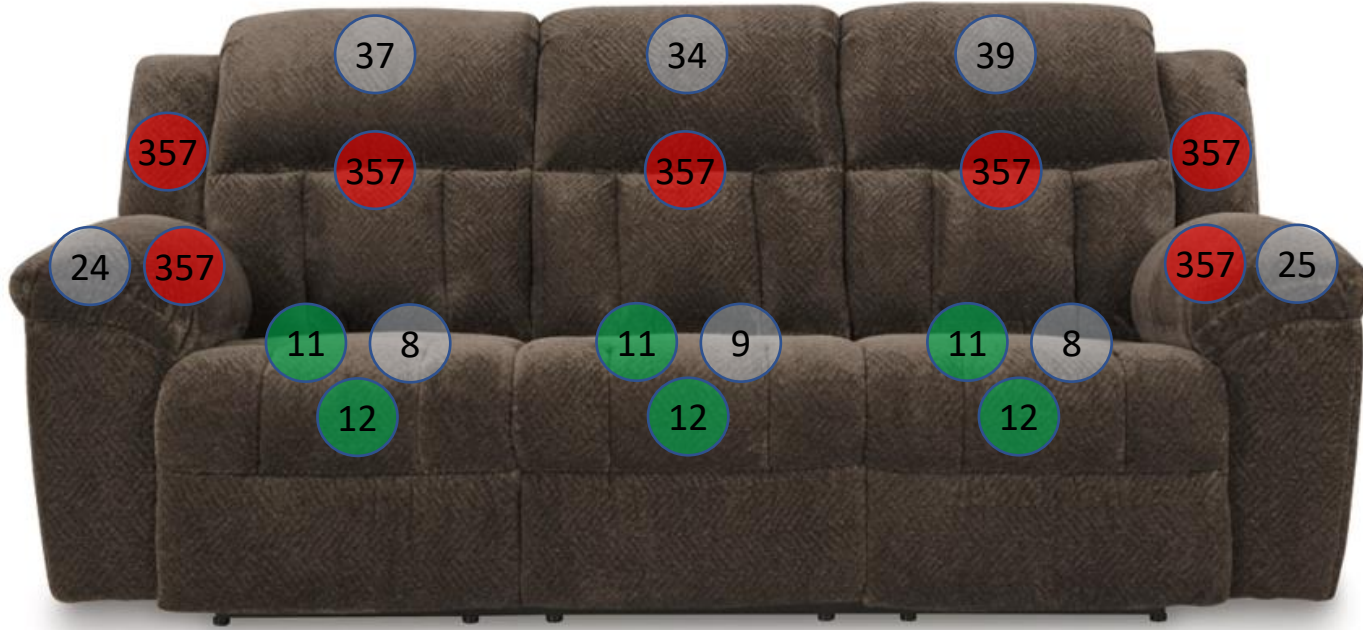



3740788



Call out	Description
	Blown Fiber
	Cushion Chaise Pad – Top Pad
	Cushion Foam
	KD Component
	Cover

For more RPs' information, please see the following page.

Signature
DESIGN
BY **ASHLEY**



101



105



134



149



216



365



619



425



426



433



396



419



615



617









217

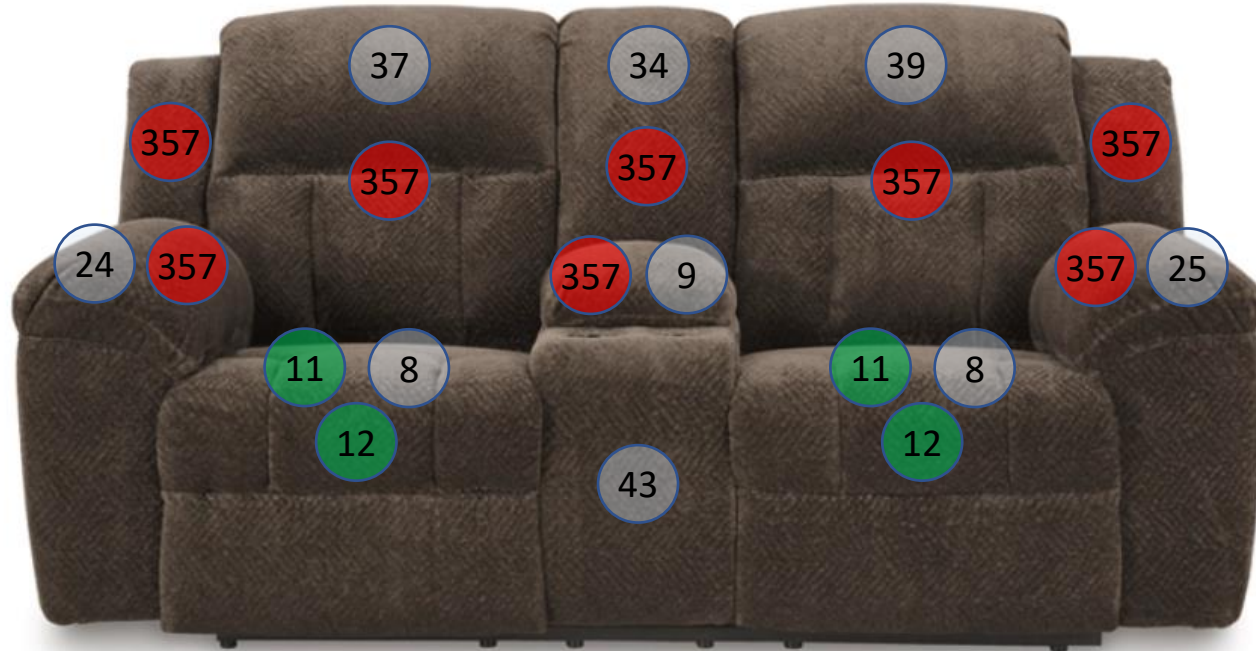

109

3740794



Call out	Description
	Blown Fiber
	Cushion Chaise Pad – Top Pad
	Cushion Foam
	KD Component
	Cover

For more RPs' information, please see the following page.



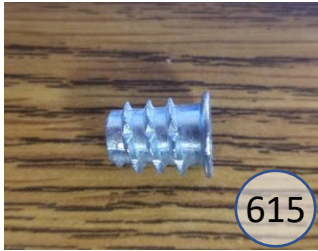
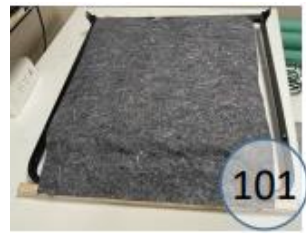

101

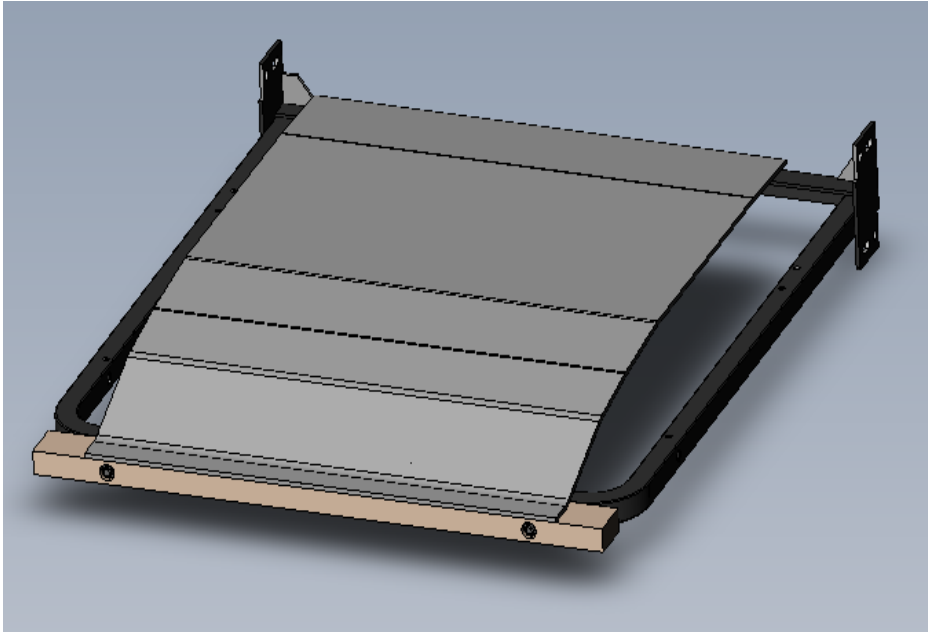

105

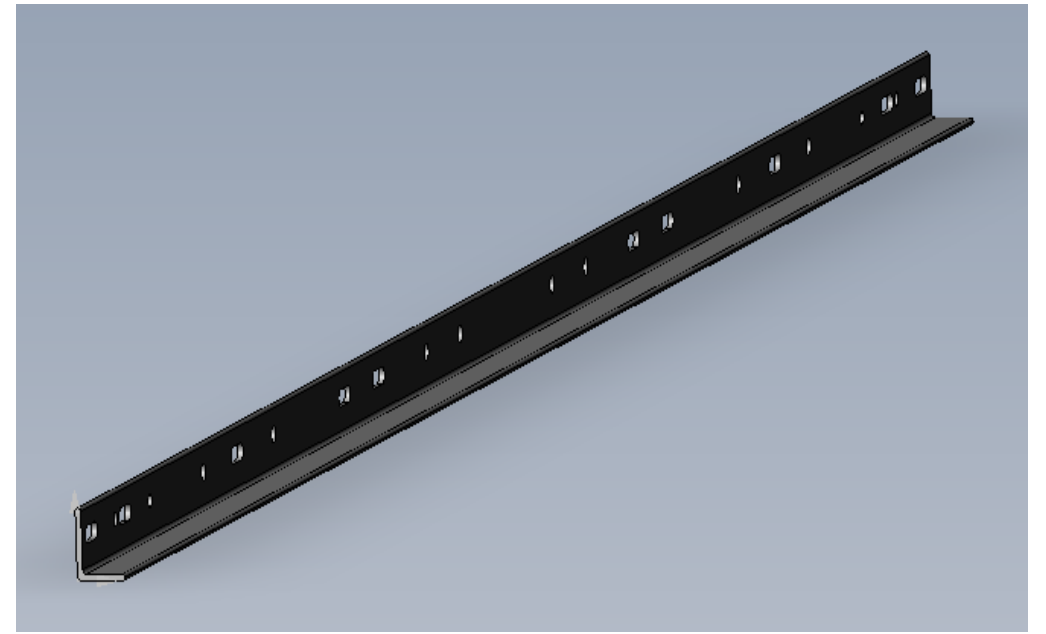

134

